

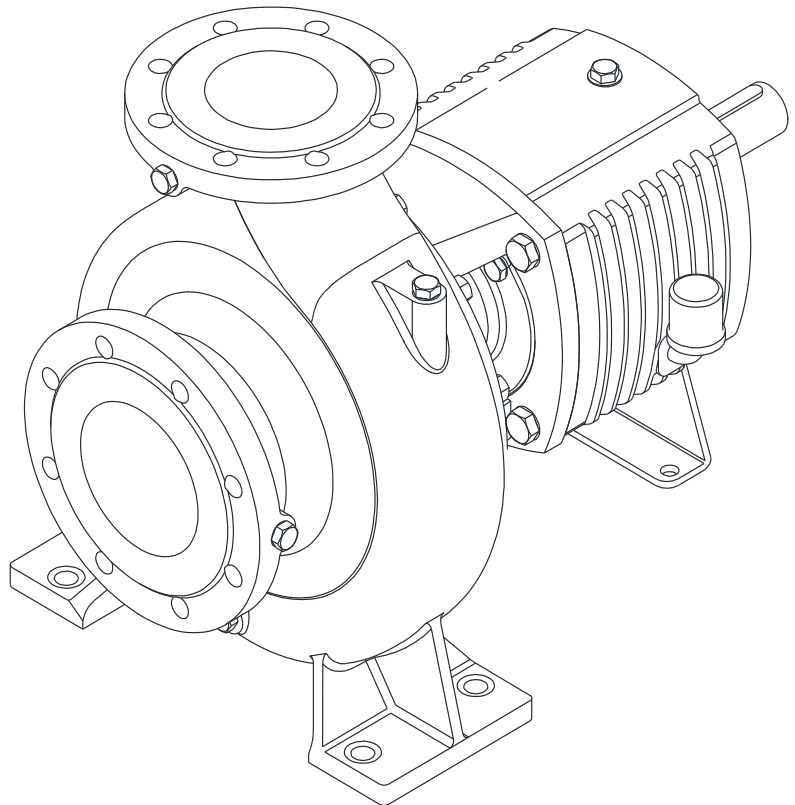

MZT PUMPI

***End suction volute casing
pumps series SCP
ISO2858 / ISO5199***

Technical catalog





CONTENTS:

1. GENERAL INFORMATION 2

 1.1. Introduction 2

 1.2. Application 2

 1.3. Pump type design 2

 1.4. Pump type key 2

2. TECHNICAL DETAILS..... 3

 2.1. Materials..... 3

 2.2. Flange connections 3

 2.3. Direction of rotation 3

 2.4. Balancing 3

 2.5. Shaft sealing 3

 2.6. Back pull out design 3

 2.7. Flange forces and moments 3

 2.8. Testing and guaranties 3

 2.9. Bearing brackets 4

 2.10. Bearings and lubrication..... 4

3. DIMENSIONS - PUMP BARE SHAFT-OUTLINE DRAWING 5

4. ASSEMBLY DRAWING WITH PART LIST 6

5. PUMP EXPLODED VIEW 7

6. PERFORMANCE CURVES 8



1. GENERAL INFORMATION

1.1. Introduction

SCP series pumps are horizontal, single stage, end suction, radially split volute casing, designed in accordance with ISO2858 and ISO5199.

1.2. Application

SCP series can be applied for transport for liquid transfer and circulation of cold and hot clean or slightly polluted water, for handling aggressive organic and inorganic liquids in the chemical and petrochemical industries.

Typical applications in:

- Municipal water supply
- Food industry
- Chemical and petrochemical industry
- Energy sector
- Industrial plants
- Boiler feed and condensate systems
- Irrigation and dewatering
- General process industry and etc.

Capacity:	up to 2500 [m ³ /h]
Differential head:	up to 150 [m]
Design pressure	up to 16 [bar]
Speed:	up to 3600 [rpm]
Temperature range:	up to 160 [°C]

1.3. Pump type design

SCP type of pump is end suction centrifugal type of pump where following design solutions are applied:

- Horizontal design
- Foot mounted
- Not self-priming
- Single volute pump casing
- Closed impeller
- Beck pull out design
- Ratings and volute casing connections according ISO 2858

1.4. Pump type key (Designation)

Example:

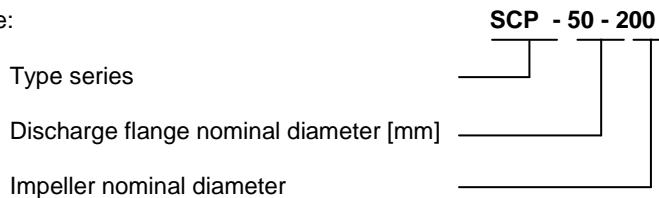



2. TECHNICAL DETAILS

2.1. Materials

	Pump Part	Material
1	Volute casing	Cast iron / Nodular cast iron / Bronze / Steel / Stainless steel / Duplex
2	Impeller	Cast iron / Nodular cast iron / Bronze / Steel / Stainless steel / Duplex
3	Casing cover	Cast iron / Bronze / Steel / Stainless steel
4	Shaft	Stainless Steel
5	Intermediate bearing	NBR / Composite / Bronze / Graphite
6	Impeller nut	Steel / Stainless steel
7	Wearing rings	Cast iron / Nodular cast iron / Bronze / Steel / Stainless steel / Duplex
8	Base	Steel welded construction
9	Column pipes	Steel / Stainless steel / Duplex

2.2. Flange connections

Suction (axial) and discharge (top) flanges are in accordance with EN 1092-1 PN16

<i>Connecting flanges acc. DIN EN 1092 PN 16</i>					
DN	Cf	df	Kf	Df	Lf
32	18	76	100	140	4xØ19
40	19	84	110	150	4xØ19
50	19	99	125	165	4xØ19
65	19	118	145	185	4xØ19
80	19	132	160	200	8xØ19
100	19	156	180	220	8xØ19
125	19	184	210	250	8xØ19
150	19	211	240	285	8xØ23
200	20	266	295	340	12xØ23
250	26	320	355	405	12xØ27
300	32	378	410	460	12xØ27
350	36	438	470	520	16xØ27
350	36	438	470	520	16xØ27

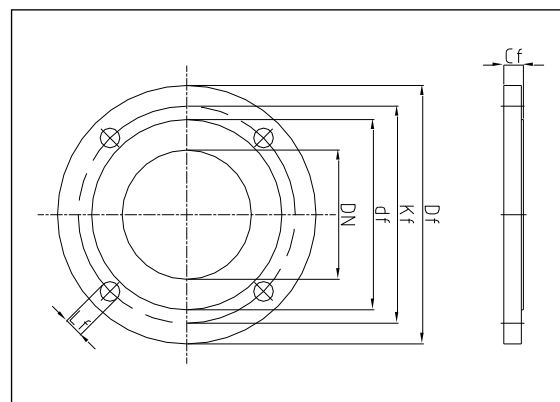

2.3. Direction of rotation

Direction of rotation is clock vice viewed from the motor side.
 Direction of air cooling of the electric motor must be toward the pump side.

2.4. Balancing

Axial thrust is balanced by back vanes or sealing gap on both sides if impeller depends of the pump size and application.

2.5. Shaft Sealing

The shaft sealing could be arranged by soft packing, single or double mechanical seal.
 In soft packing arrangements the shaft is protected by replaceable, stainless sleeve while the stuffing box can furnished with or without lantern ring.
 Single mechanical seals are according EN 12756 (DIN 24960).
 On special demand, pumps could be furnished with mechanical seal in accordance with the specific characteristics of the liquid and the operating conditions.

2.6. Back pull out design

Back pull out design allow dismantling of pumps without movement of electrical motor when spacer coupling is mounted.

2.7. Flange forces and Moments

SCP pumps are designed for handing forces and moments in accordance with ISO 5199

2.8. Testing and Guarantees

Each pump before delivery is tested:

- Hydrostatic test - 150 % over nominal pressure
- Performance tests - in accordance with ISO 9906

**2.9. Bearing brackets**

Eight different bearing bracket sizes cover the range of SCP pumps.

Outlet nozzle [mm]	Nominal impeller diameter								
	125	160	200	250	315	400	500	650	710
32	BB1	BB1	BB1	BB2					
40		BB1	BB1	BB2	BB2				
50		BB1	BB1	BB2	BB2				
65		BB2	BB2	BB2	BB3				
80		BB2	BB2	BB2	BB3	BB3			
100			BB2	BB3	BB3	BB3			
125				BB3	BB3	BB3			
150				BB3	BB4	BB4	BB4	BB6	
200				BB4	BB4	BB4	BB4	BB7	
250					BB4	BB5	BB5	BB7	BB7
300						BB6	BB6	BB7	BB7
350						BB6	BB6	BB8	BB8

2.10. Bearings and lubrication**Motor side bearings**

Outlet nozzle [mm]	Nominal impeller diameter								
	125	160	200	250	315	400	500	650	710
32	2 x 7307	2 x 7307	2 x 7307	2 x 7307					
40		2 x 7307	2 x 7307	2 x 7307	2 x 7307				
50		2 x 7307	2 x 7307	2 x 7307	2 x 7307				
65		2 x 7307	2 x 7307	2 x 7307	2 x 7311				
80		2 x 7307	2 x 7307	2 x 7307	2 x 7311	2 x 7311			
100			2 x 7307	2 x 7311	2 x 7311	2 x 7311			
125				2 x 7311	2 x 7311	2 x 7311			
150				2 x 7311	2 x 7313	2 x 7313	2 x 7313	2 x 7319	
200				2 x 7313	2 x 7313	2 x 7313	2 x 7313	2 x 7324	
250					2 x 7313	2 x 7315	2 x 7315	2 x 7324	2 x 7324
300						2 x 7319	2 x 7319	2 x 7324	2 x 7324
350						2 x 7319	2 x 7319	2 x 7324	2 x 7324

Impeller side bearings

Outlet nozzle [mm]	Nominal impeller diameter								
	125	160	200	250	315	400	500	650	710
32	NU307	NU 307	NU 307	NU 307	-	-	-	-	2222
40	-	NU 307	NU 307	NU 307	NU 307				
50	-	NU 307	NU 307	NU 307	NU 307				
65	-	NU 307	NU 307	NU 307	NU 311				
80	-	NU 307	NU 307	NU 307	NU307	NU307			
100			NU307	NU307	NU307	NU307			
125				NU307	NU307	NU307			
150				NU307	NU313	NU313	NU313	NU416	
200				NU313	NU313	NU313	NU313	NU324	
250					NU313	NU413	NU413	NU324	NU324
300						NU416	NU416	NU324	NU324
350						NU416	NU416	NU324	NU324

Lubrication : oil SAE 30



4. ASSEMBLY DRAWING WITH PART LIST

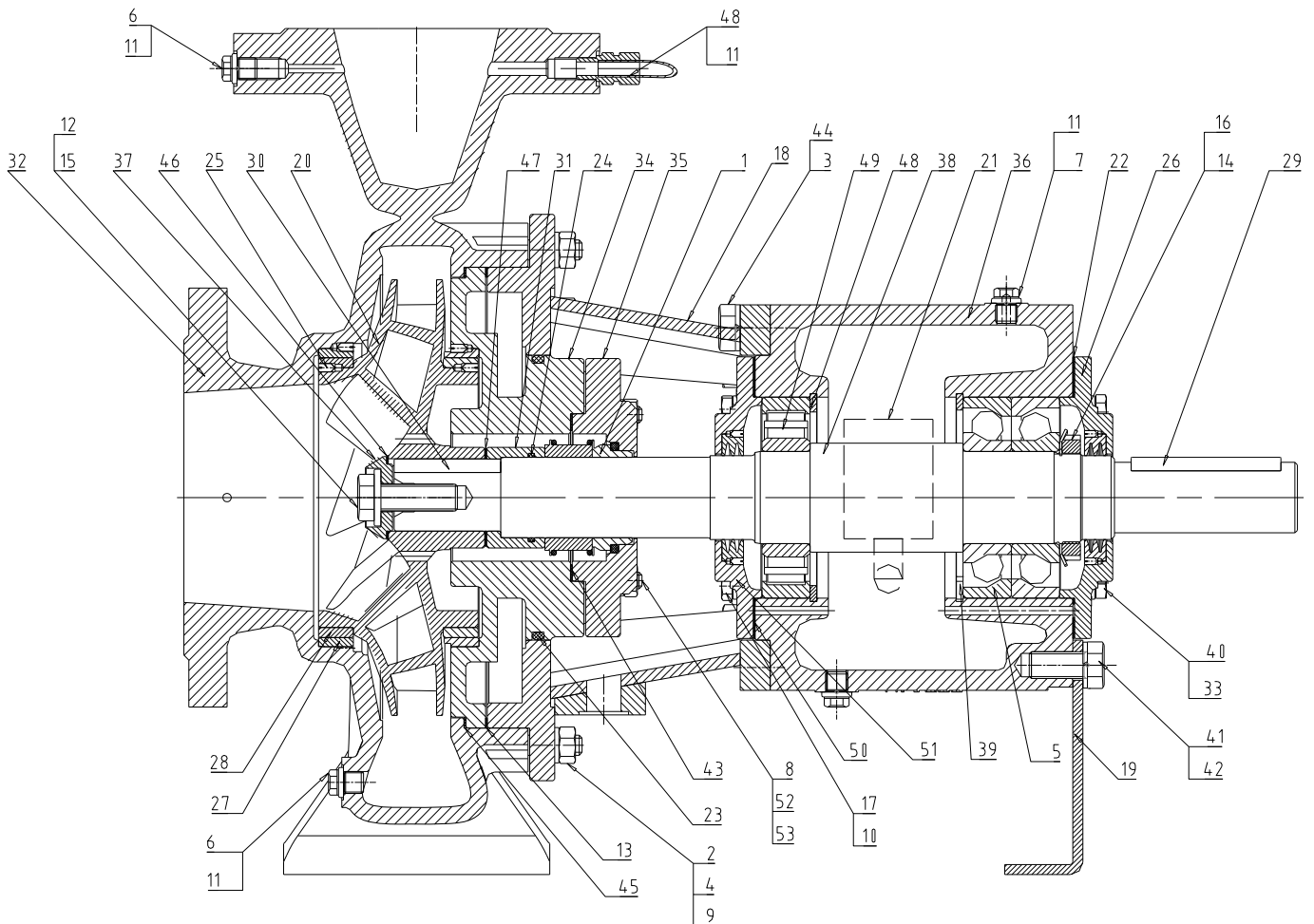

1	Mechanical seal	15	Washer	29	Key	43	Gasket
2	Nut	16	Locking washer	30	Key	44	Washer
3	Screw	17	Screw	31	Sleeve	45	Gasket
4	Washer	18	Console	32	Volute casing	46	Gasket
5	Ball bearings	19	Foot	33	Washer	47	Gasket
6	Screw	20	Impeller	34	Volute casing cover	48	Pipe (hose)
7	Vent screw	21	Constant oil leveler	35	Mechanical seal cover	49	Cylindrical bearing
8	Screw	22	Gasket	36	Bearing bracket	50	Gasket
9	Screw	23	O-ring	37	Disc	51	Bearing cover
10	Washer	24	O-ring	38	Shaft	52	Nut
11	Washer	25	Screw for wearing rings fixing	39	Circlip	53	Washer
12	Impeller fixing screw	26	Bearing cover	40	Screw		
13	Gasket	27	Casing wearing ring	41	Screw		
14	Lock nut	28	Impeller wearing ring	42	Washer		



5. PUMP EXPLODED VIEW

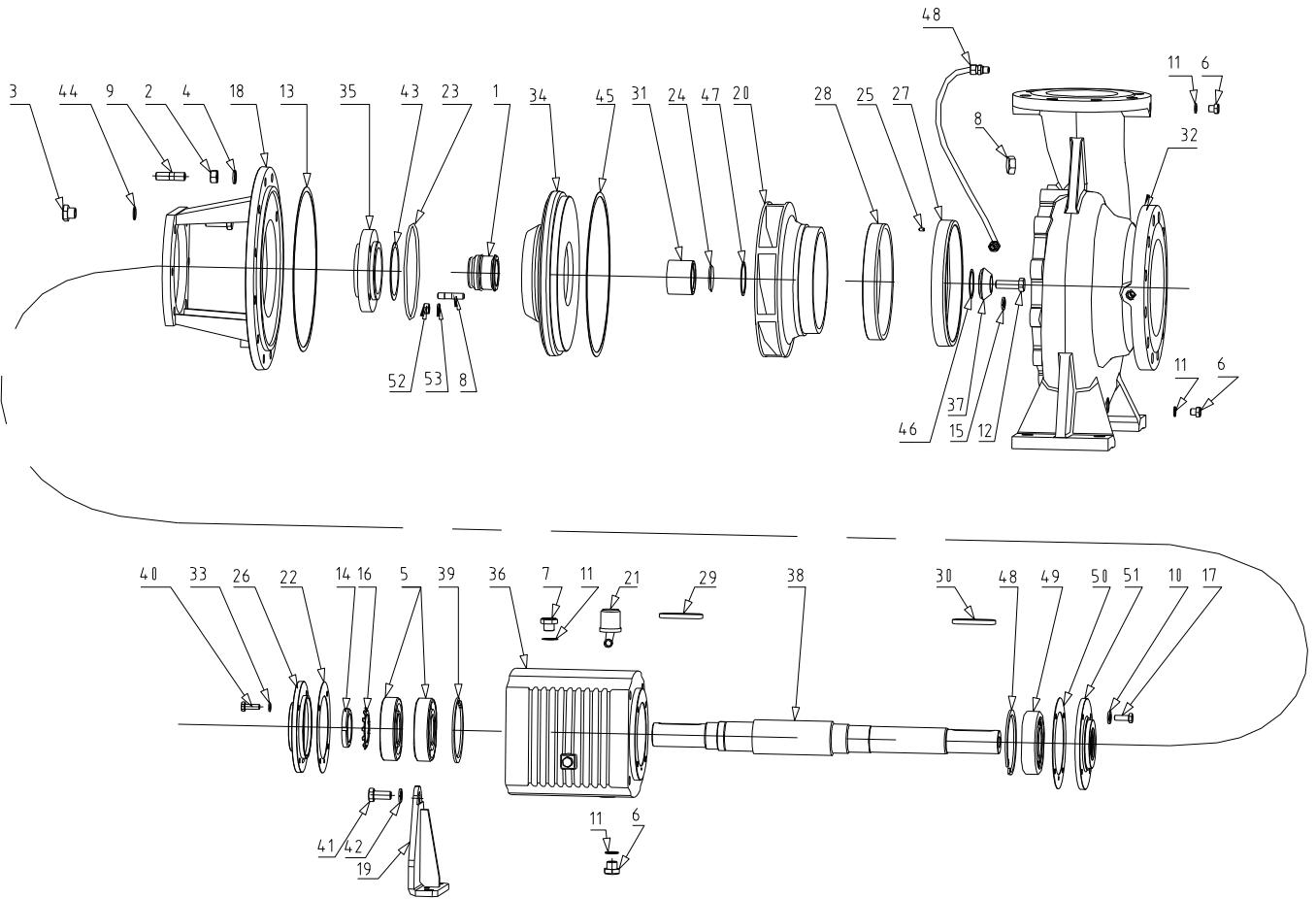

1	Mechanical seal	15	Washer	29	Key	43	Gasket
2	Nut	16	Locking washer	30	Key	44	Washer
3	Screw	17	Screw	31	Sleeve	45	Gasket
4	Washer	18	Console	32	Volute casing	46	Gasket
5	Ball bearings	19	Foot	33	Washer	47	Gasket
6	Screw	20	Impeller	34	Volute casing cover	48	Pipe (hose)
7	Vent screw	21	Constant oil leveler	35	Mechanical seal cover	49	Cylindrical bearing
8	Screw	22	Gasket	36	Bearing bracket	50	Gasket
9	Screw	23	O-ring	37	Disc	51	Bearing cover
10	Washer	24	O-ring	38	Shaft	52	Nut
11	Washer	25	Screw for wearing rings fixing	39	Circlip	53	Washer
12	Impeller fixing screw	26	Bearing cover	40	Screw		
13	Gasket	27	Casing wearing ring	41	Screw		
14	Lock nut	28	Impeller wearing ring	42	Washer		



6. PERFORMANCE CURVES

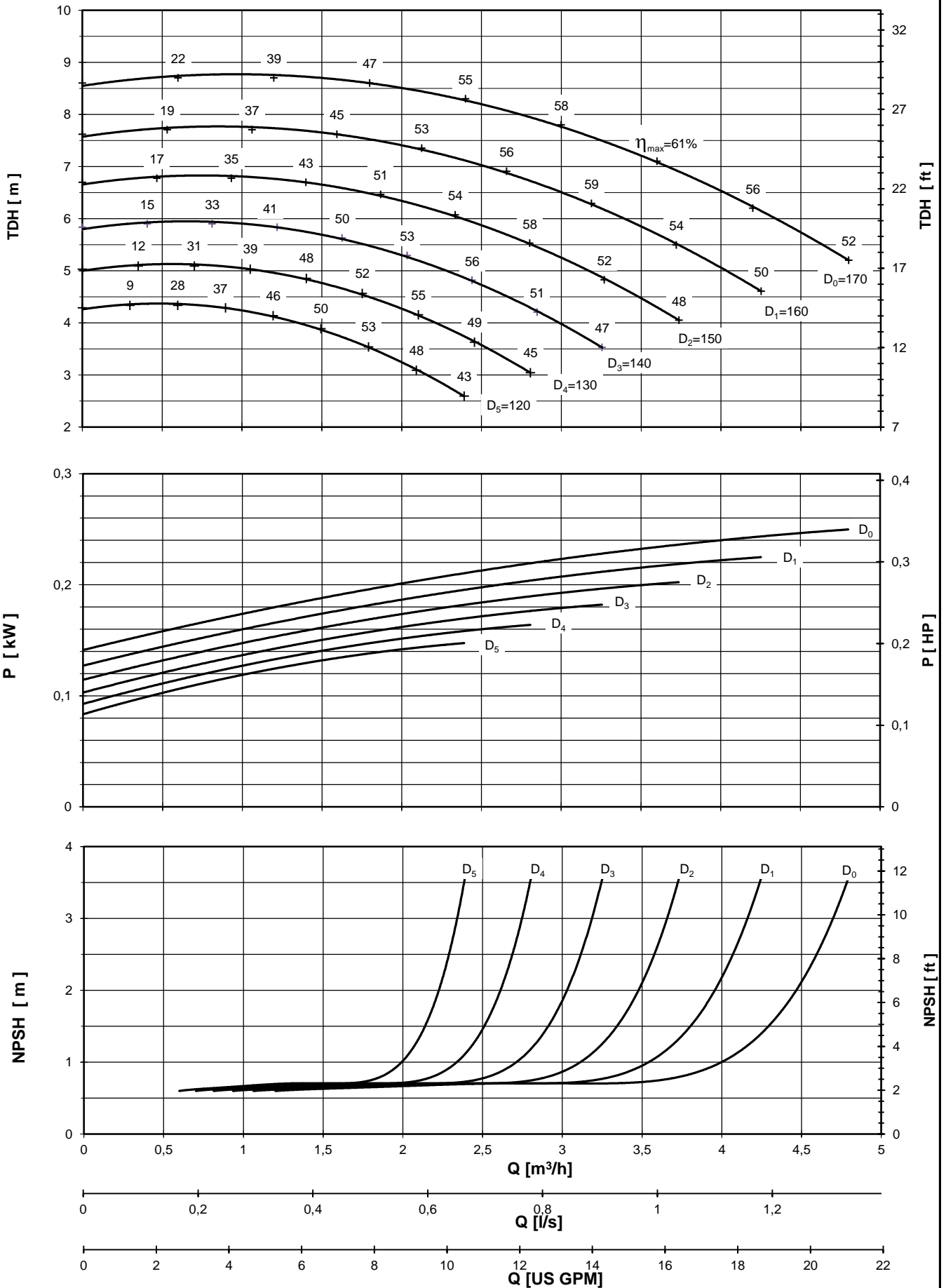

Performance curves are valid for clean cold water-kinematic viscosity 1 [mm²/s], density 1000 [kg/m³]. Methods and tolerances of presented performance curves are in accordance with ISO 9906 - Annex A

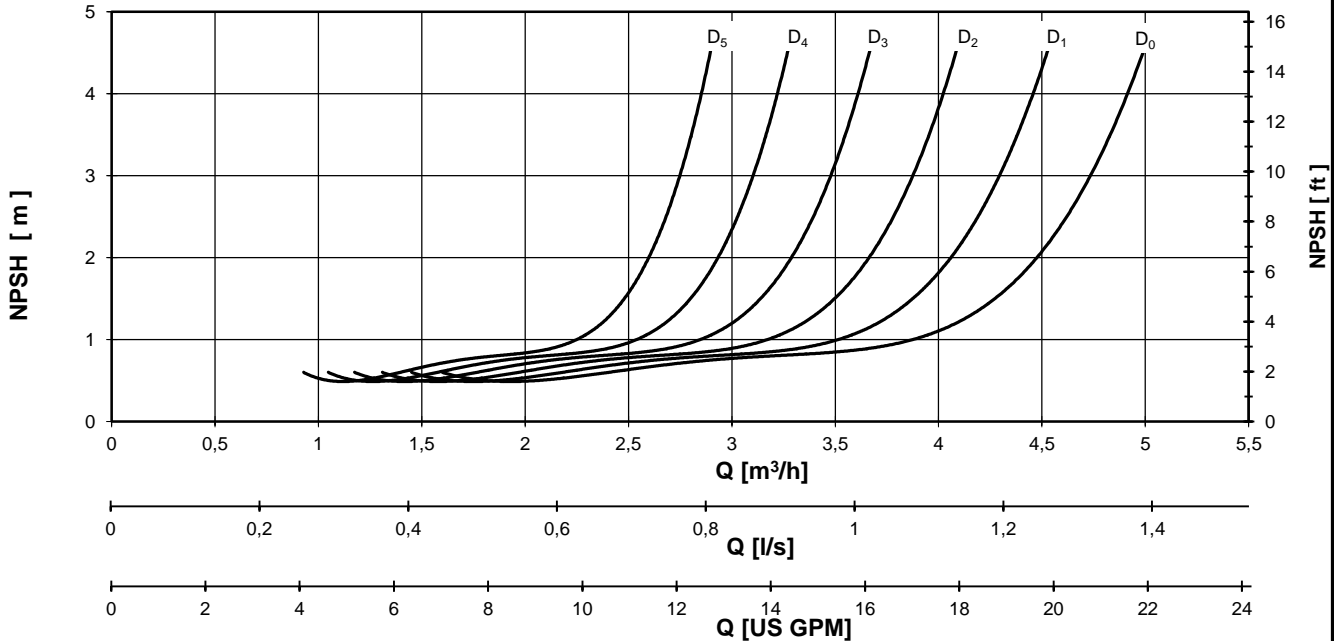
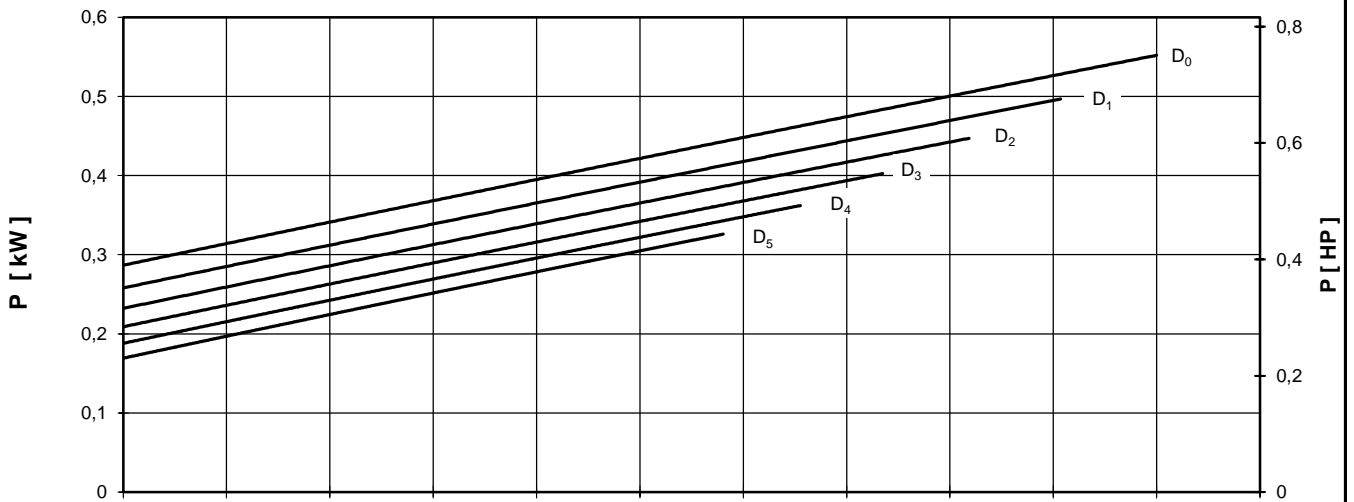
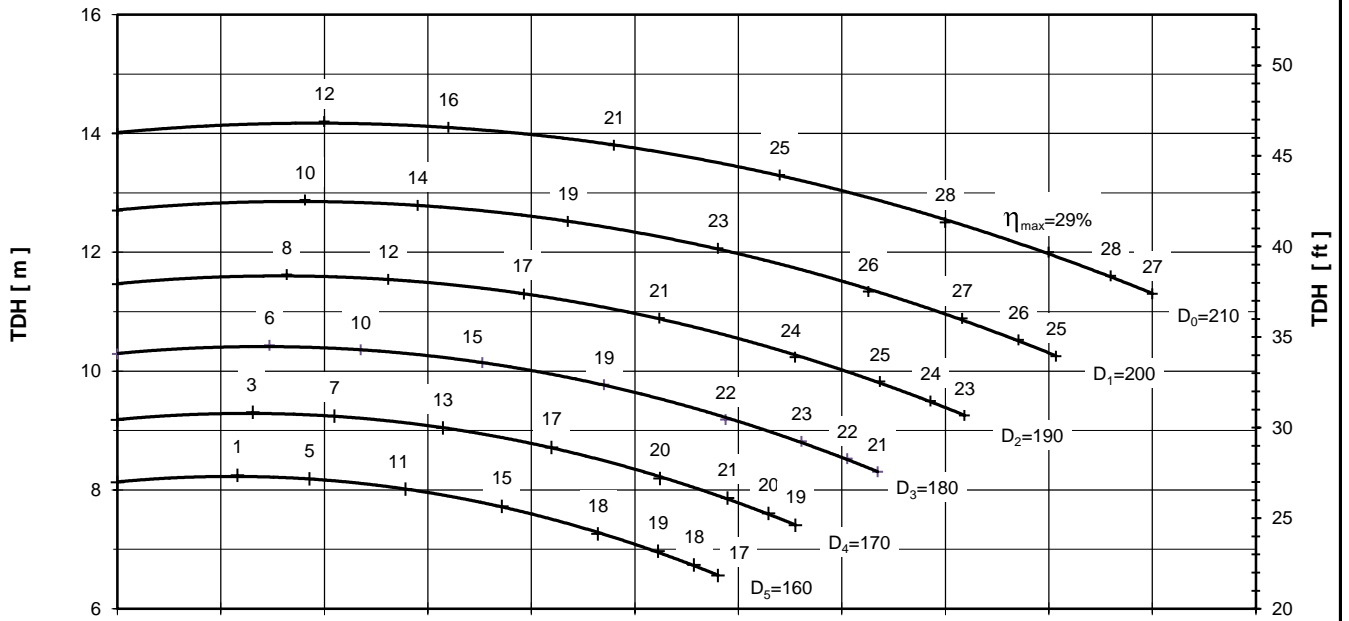



PUMP PERFORMANCE CURVES
No. 4HD.0142.03

PUMP TYPE
SCP 32 - 160
1450 [rpm]

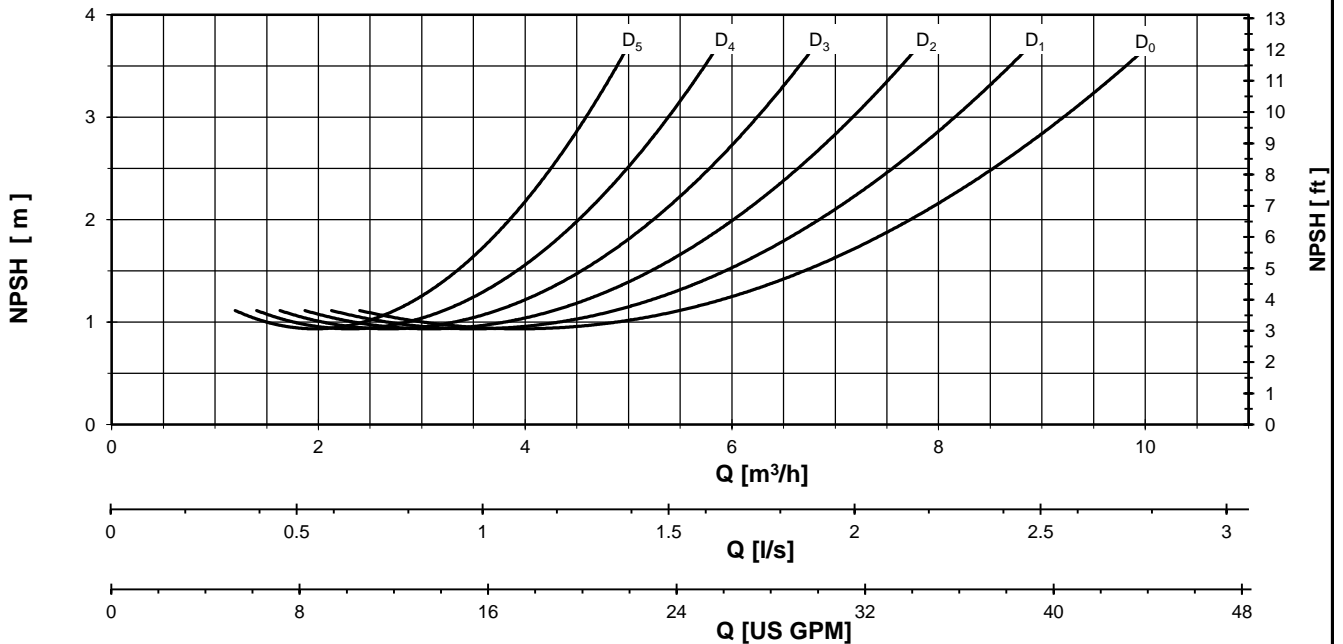
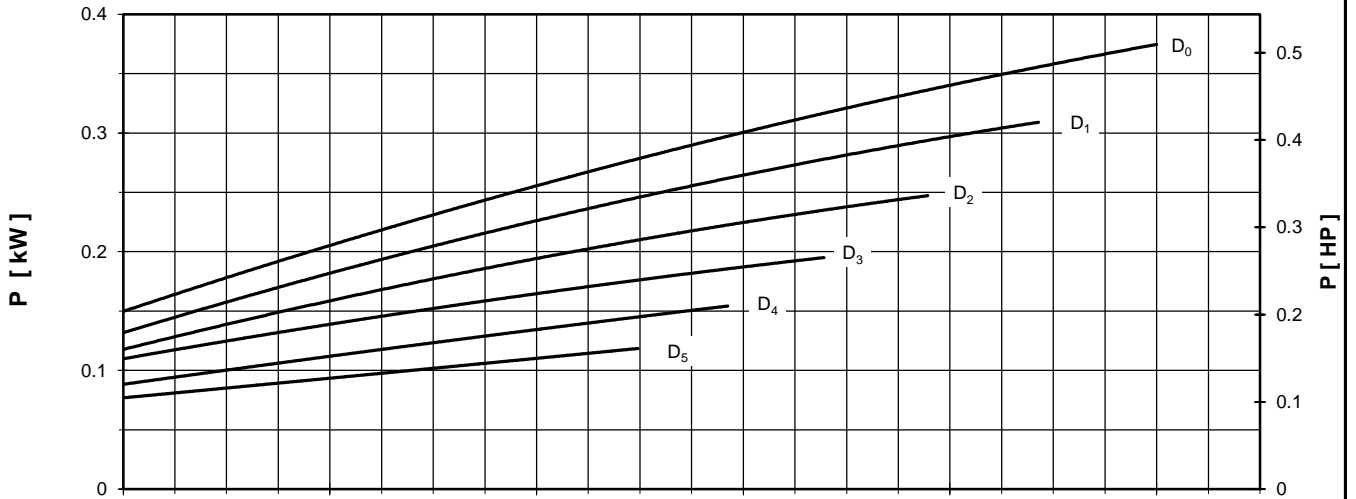
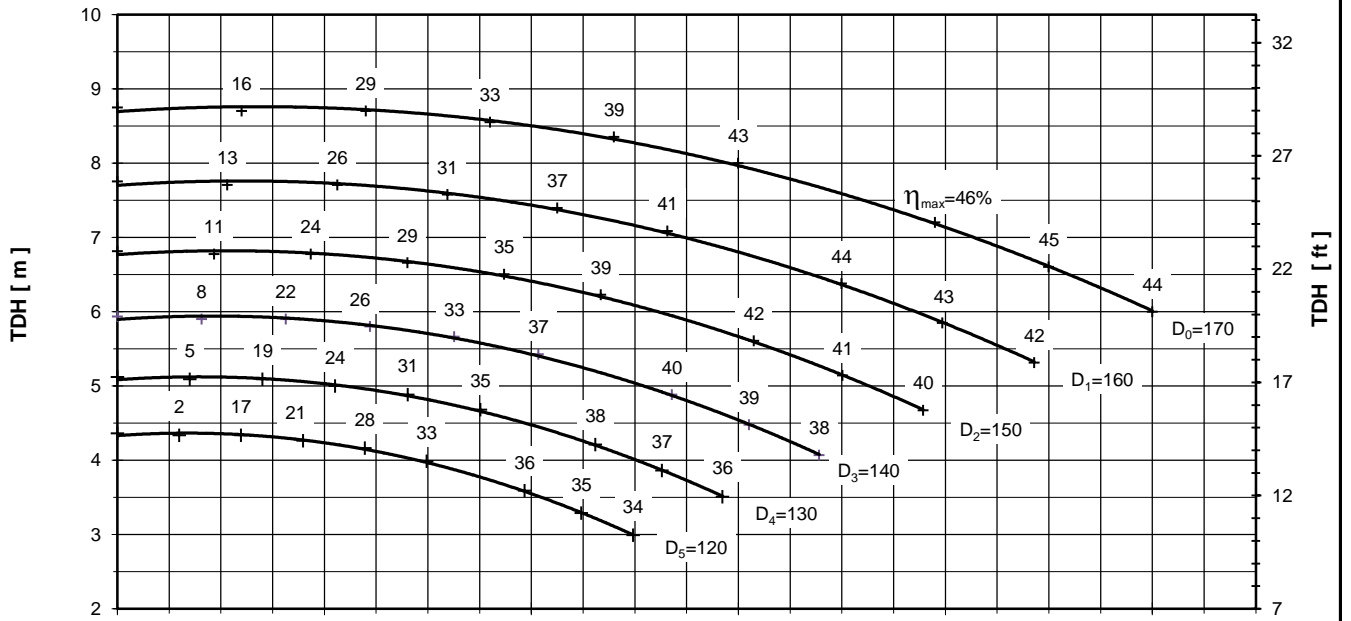

Performance curves are valid for clean cold water-kinematic viscosity 1 [mm²/s], density 1000 [kg/m³]. Methods and tolerances of presented performance curves are in accordance with ISO 9906 - Annex A

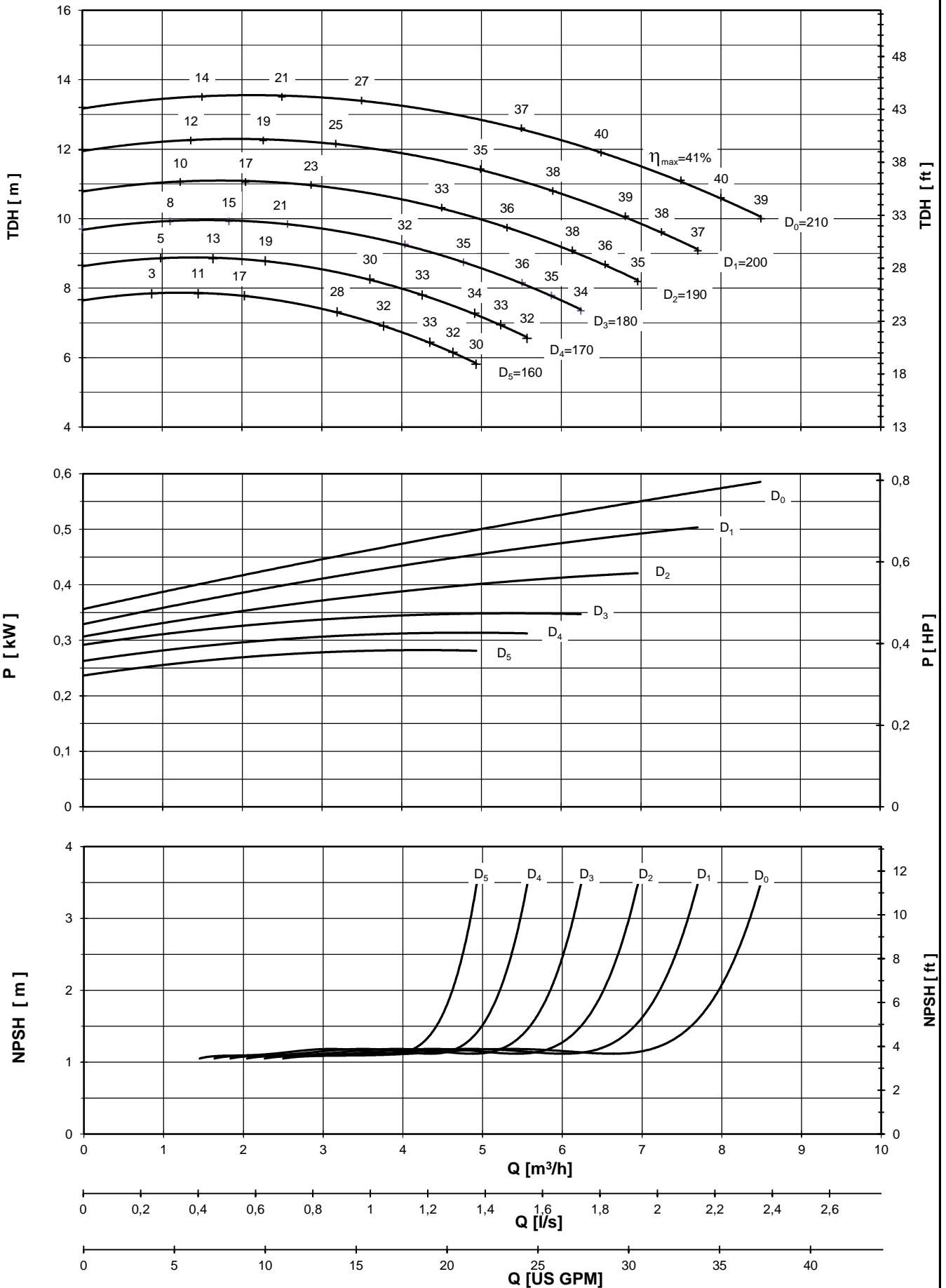

Performance curves are valid for clean cold water-kinematic viscosity 1 [mm²/s], density 1000 [kg/m³]. Methods and tolerances of presented performance curves are in accordance with ISO 9906 - Annex A

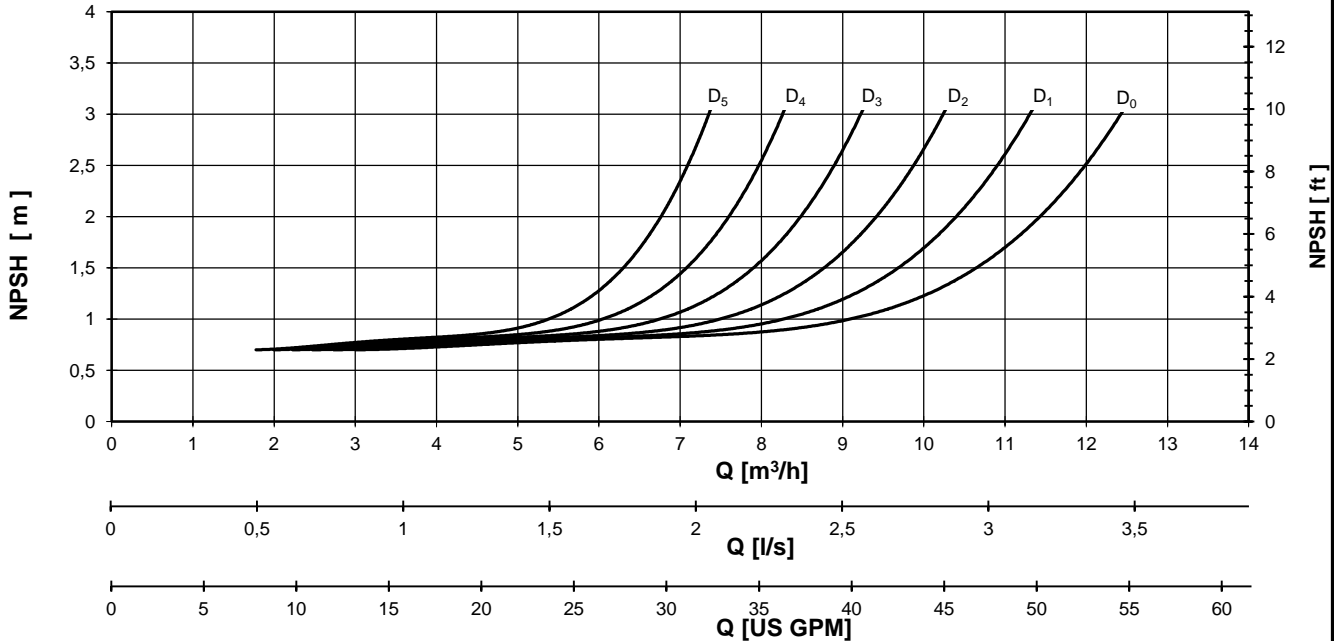
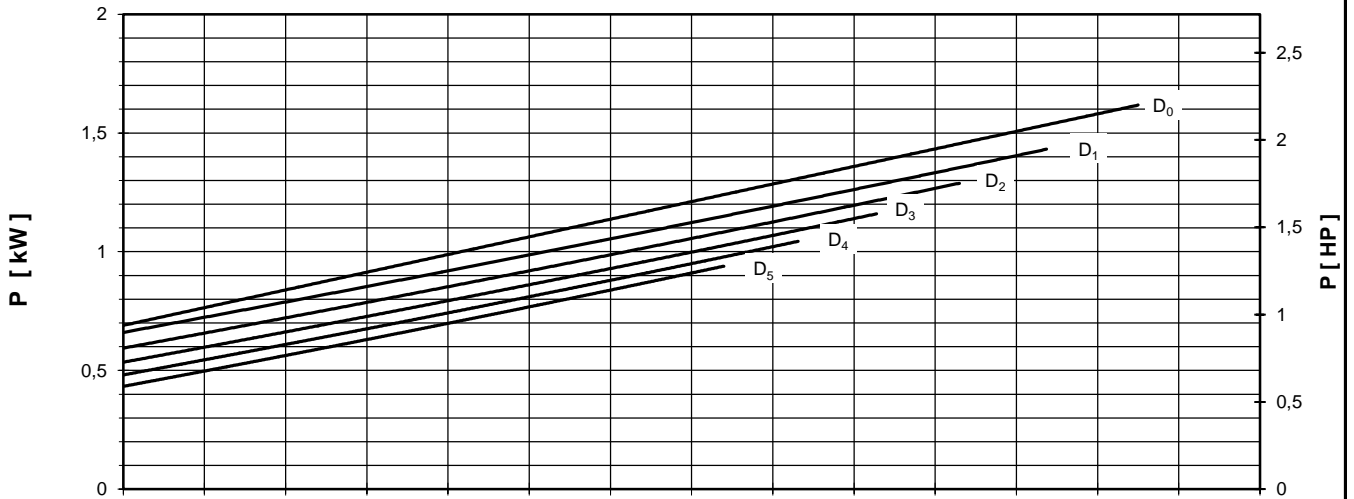
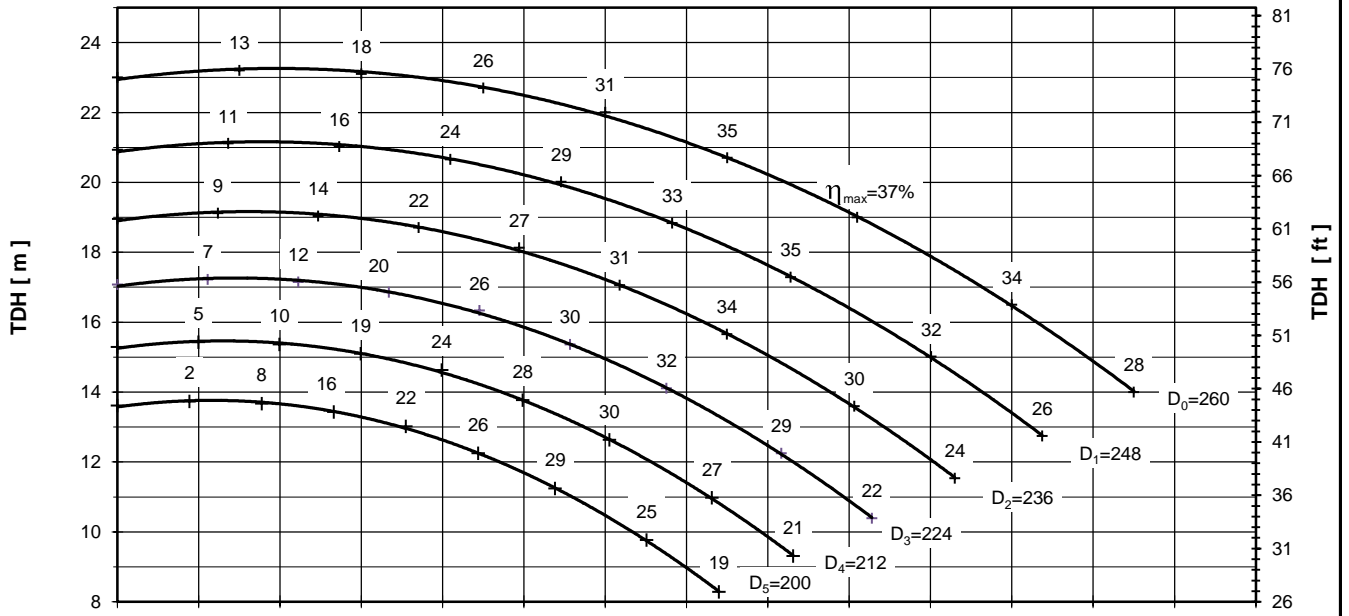

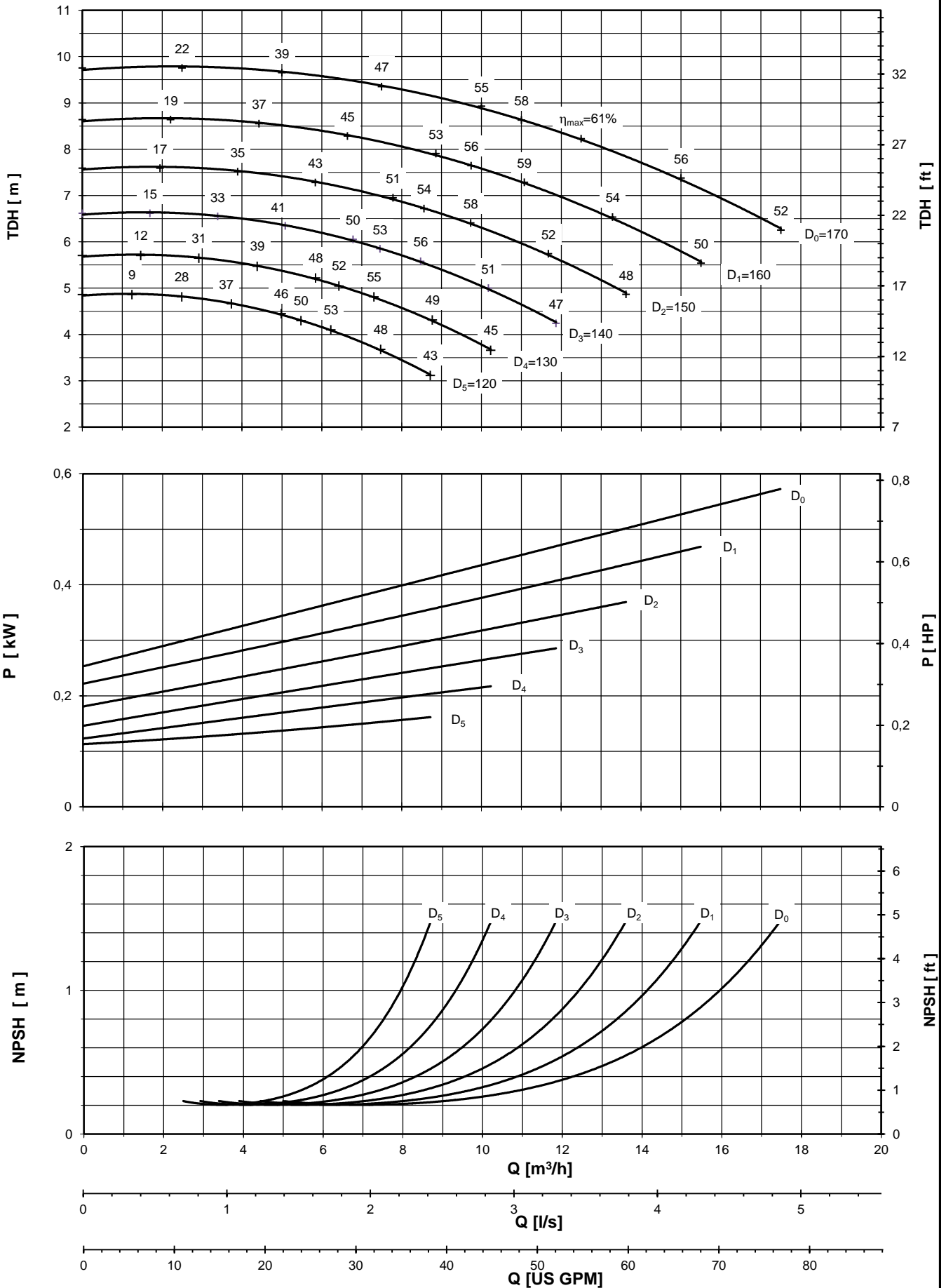

Performance curves are valid for clean cold water-kinematic viscosity 1 [mm²/s], density 1000 [kg/m³]. Methods and tolerances of presented performance curves are in accordance with ISO 9906 - Annex A

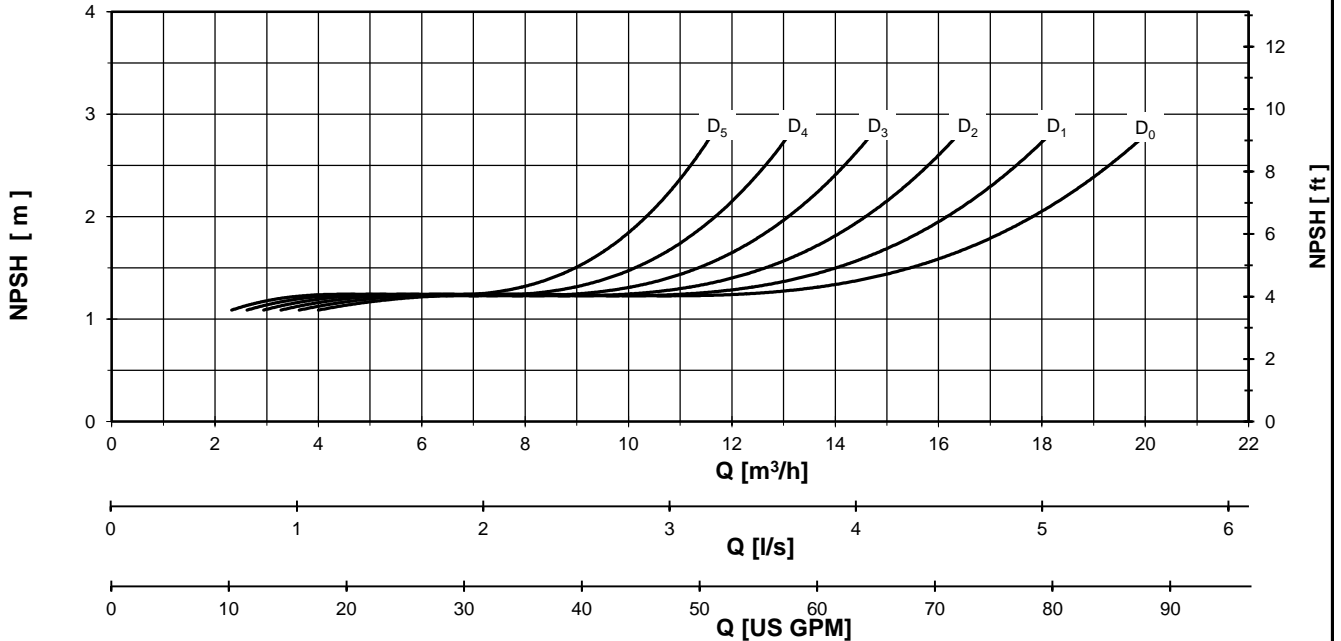
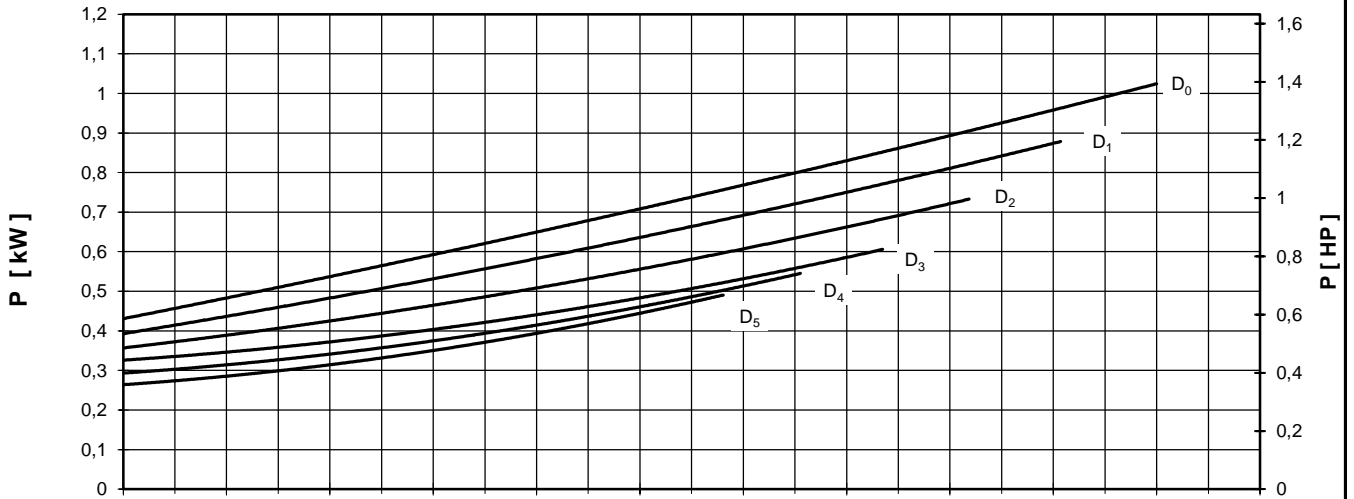
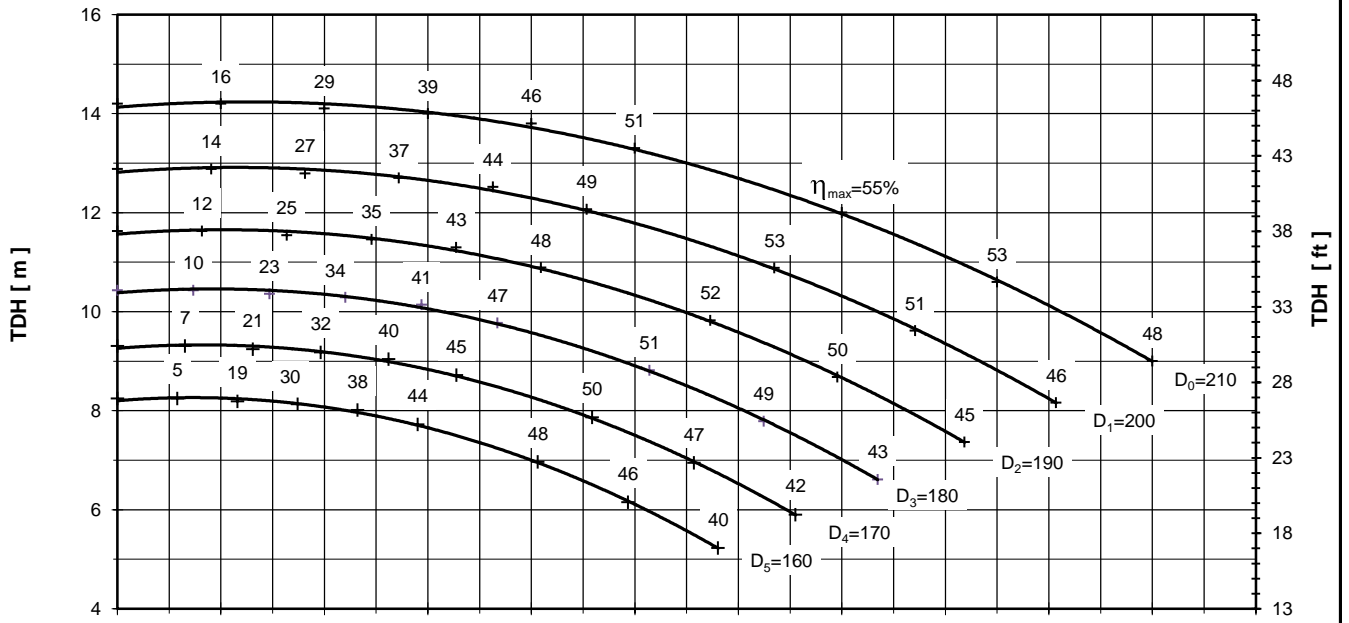



PUMP PERFORMANCE CURVES
No. 4HS.0148.03

PUMP TYPE
SCP 40 - 250
1450 [rpm]

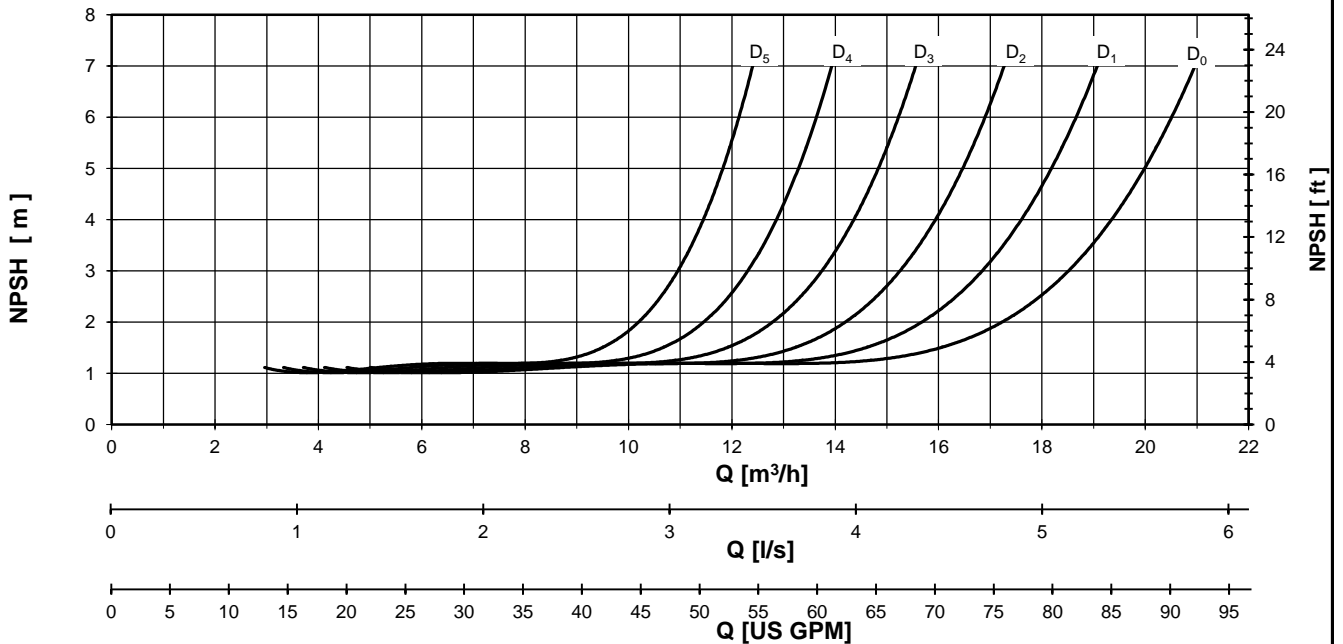
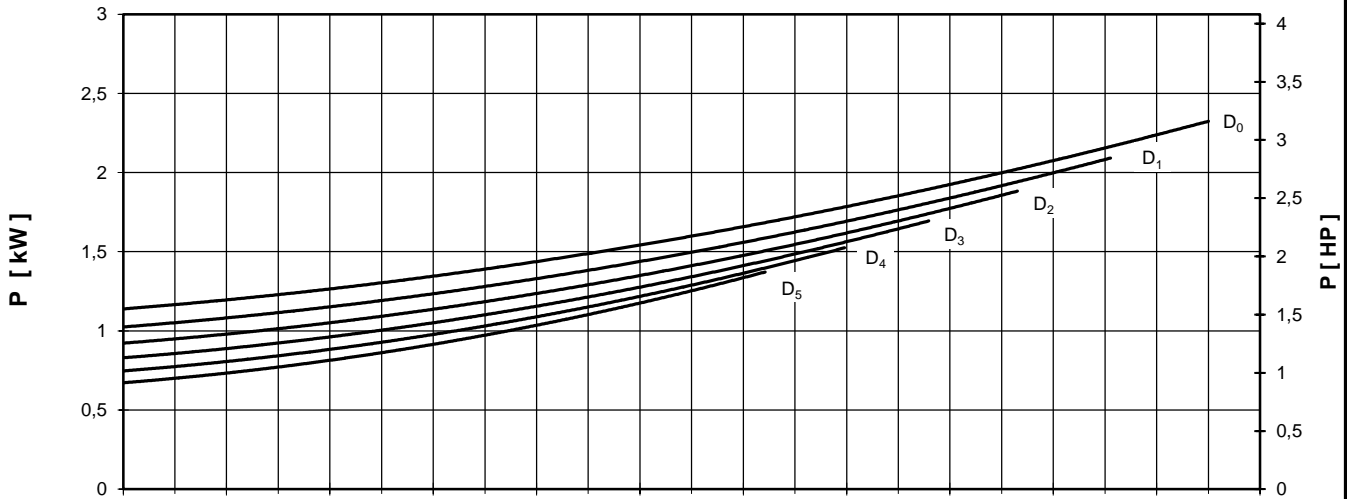
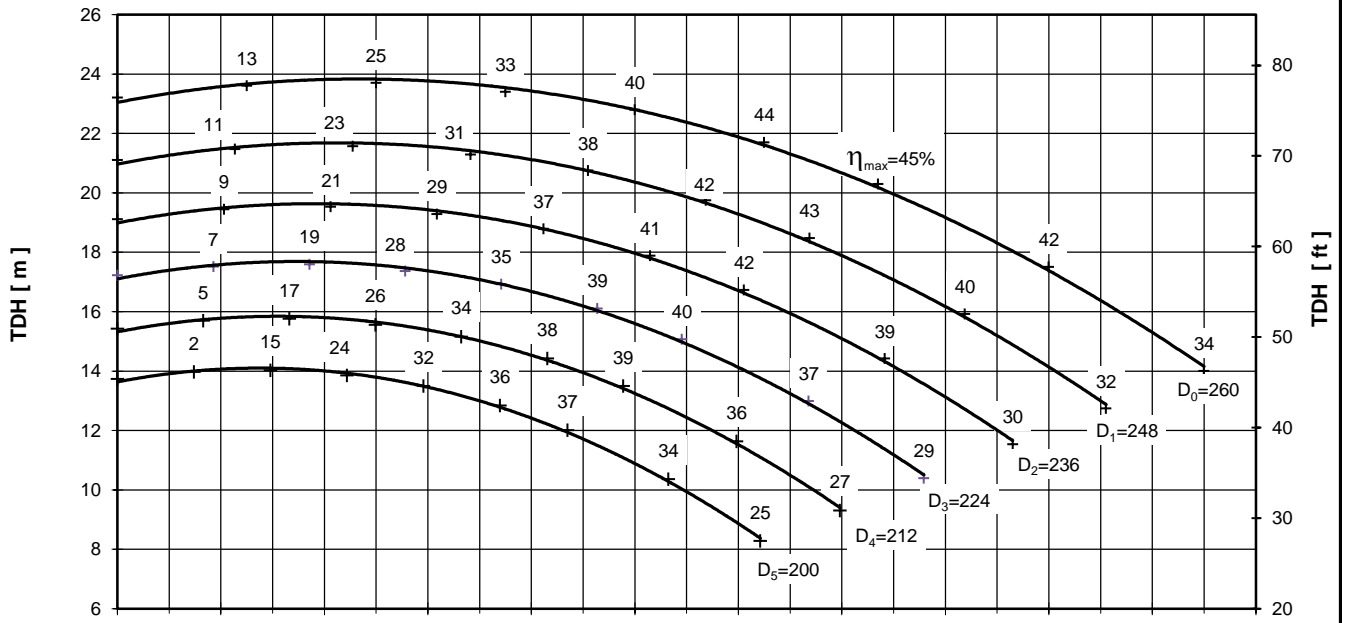

Performance curves are valid for clean cold water-kinematic viscosity 1 [mm²/s], density 1000 [kg/m³]. Methods and tolerances of presented performance curves are in accordance with ISO 9906 - Annex A



PUMP PERFORMANCE CURVES
No. 4HD.0149.03

PUMP TYPE
SCP 40 - 315
1450 [rpm]

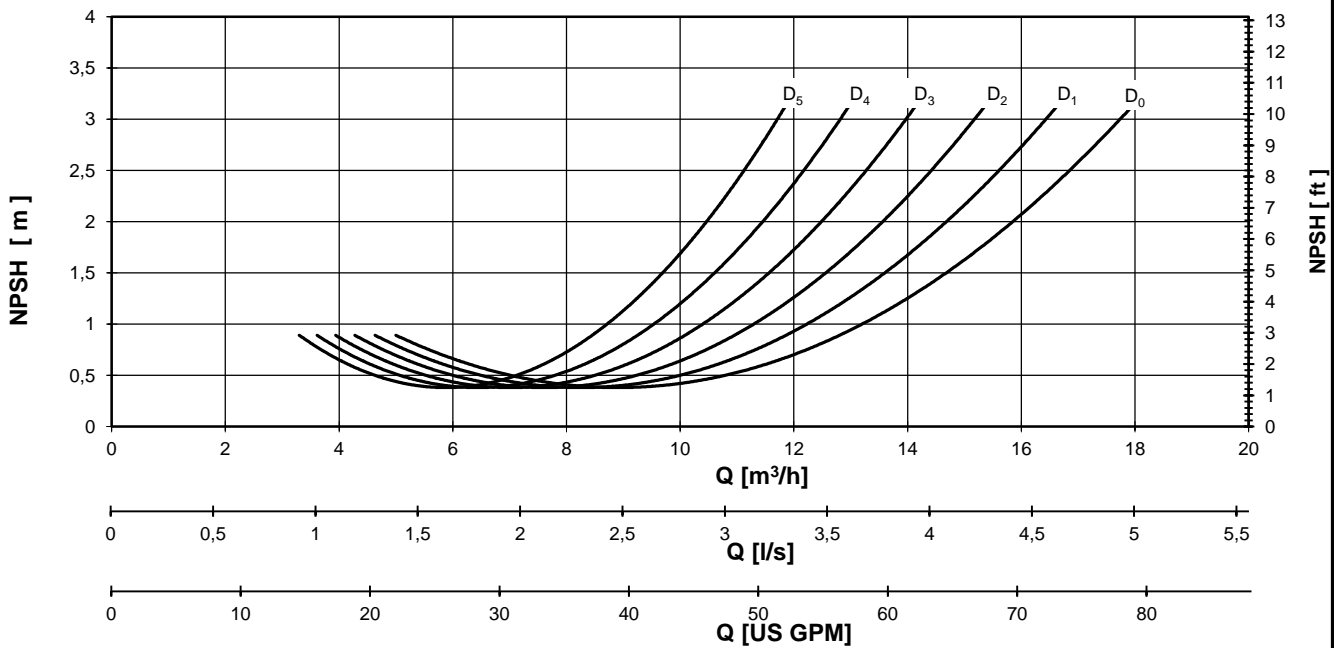
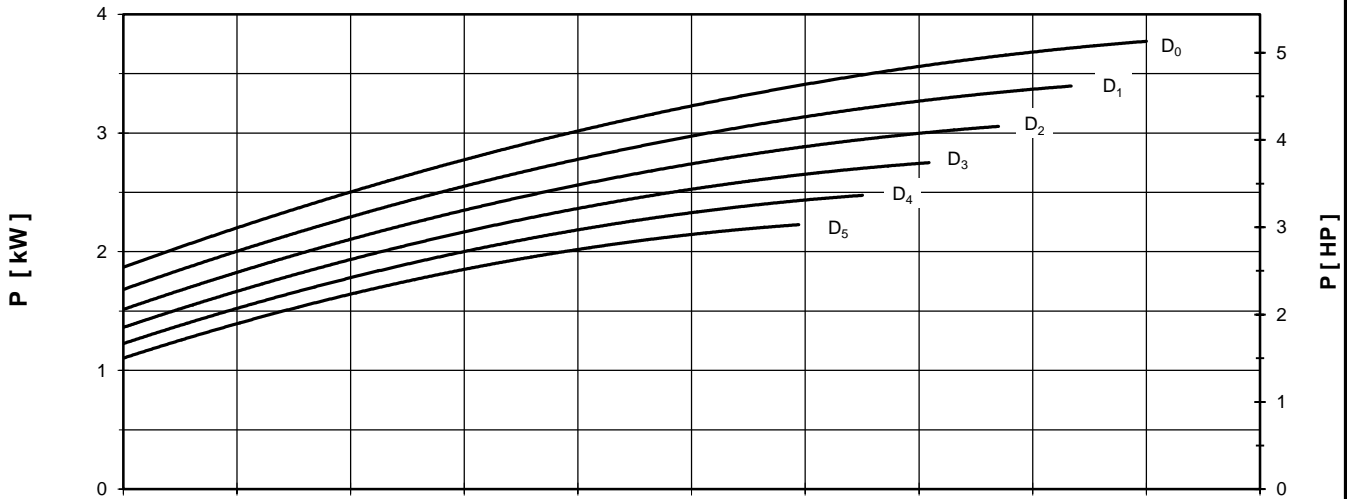
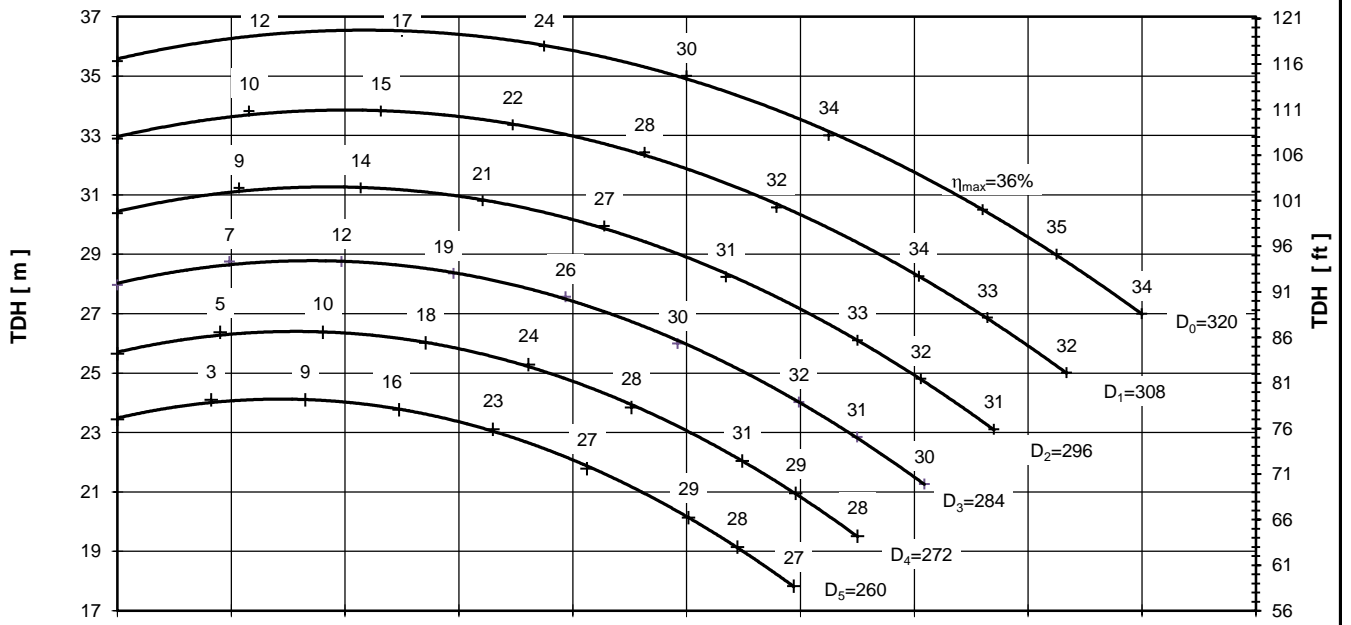

Performance curves are valid for clean cold water-kinematic viscosity 1 [mm²/s], density 1000 [kg/m³]. Methods and tolerances of presented performance curves are in accordance with ISO 9906 - Annex A

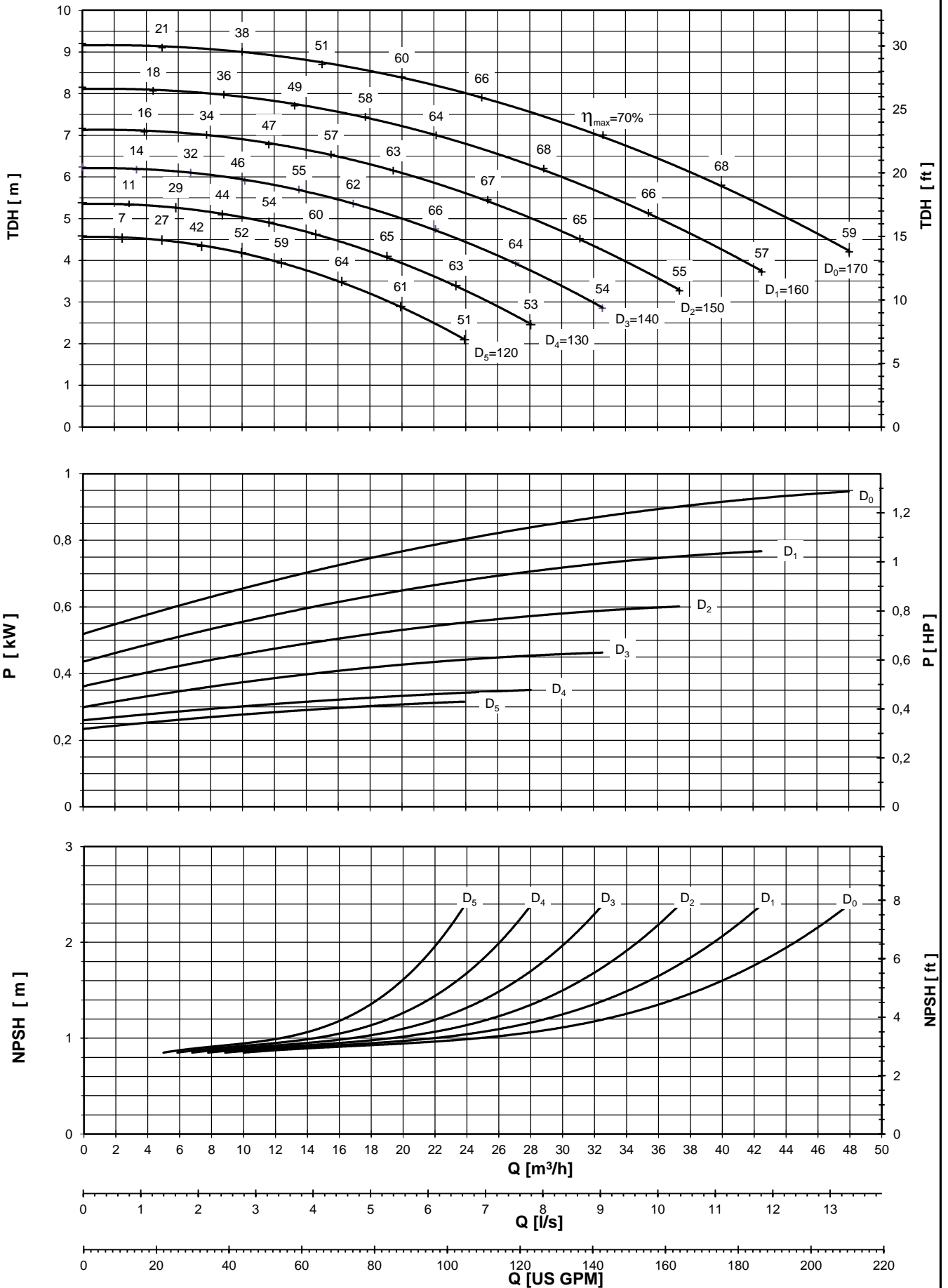

Performance curves are valid for clean cold water-kinematic viscosity 1 [mm²/s], density 1000 [kg/m³]. Methods and tolerances of presented performance curves are in accordance with ISO 9906 - Annex A

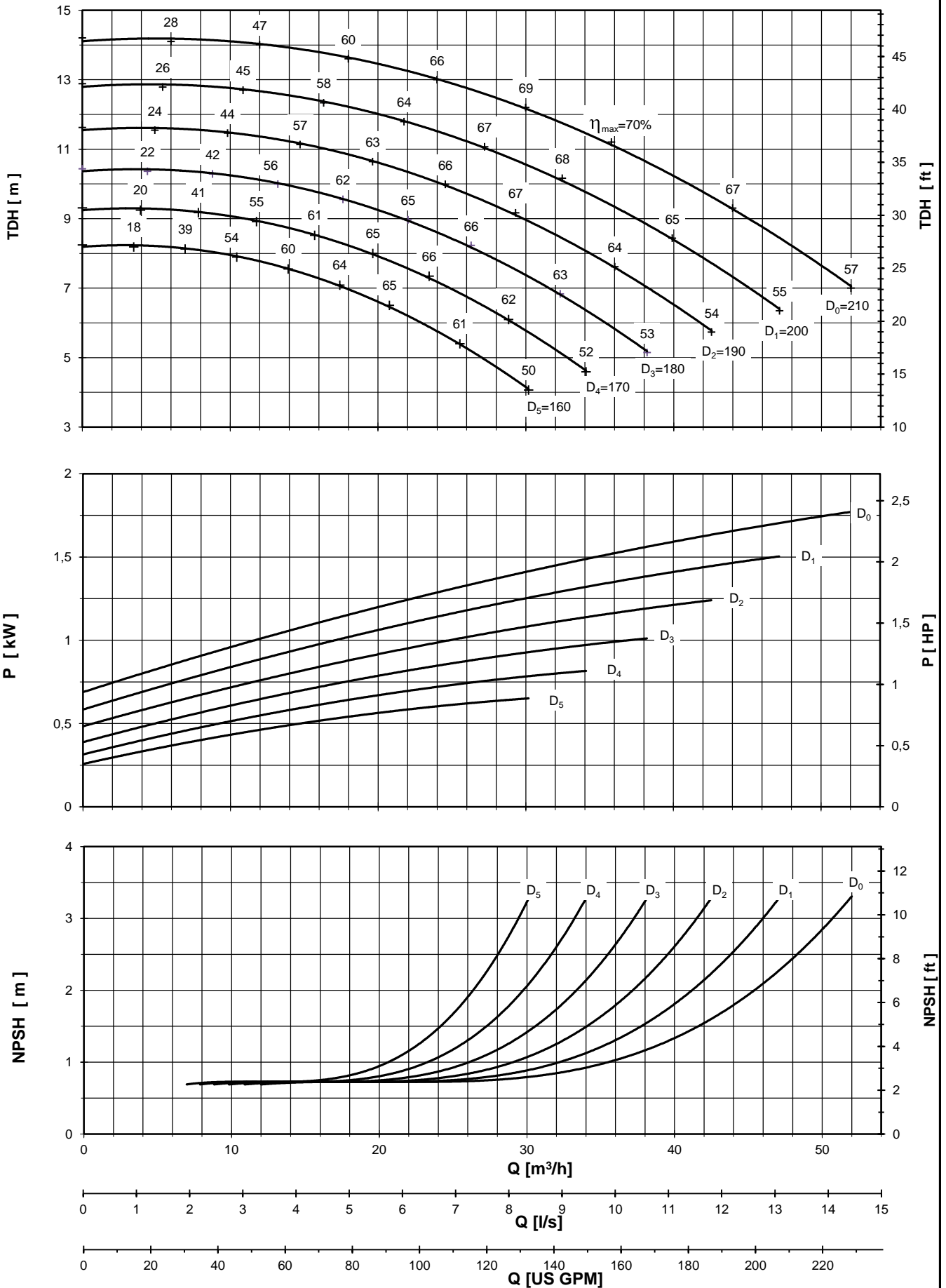

Performance curves are valid for clean cold water-kinematic viscosity 1 [mm²/s], density 1000 [kg/m³]. Methods and tolerances of presented performance curves are in accordance with ISO 9906 - Annex A

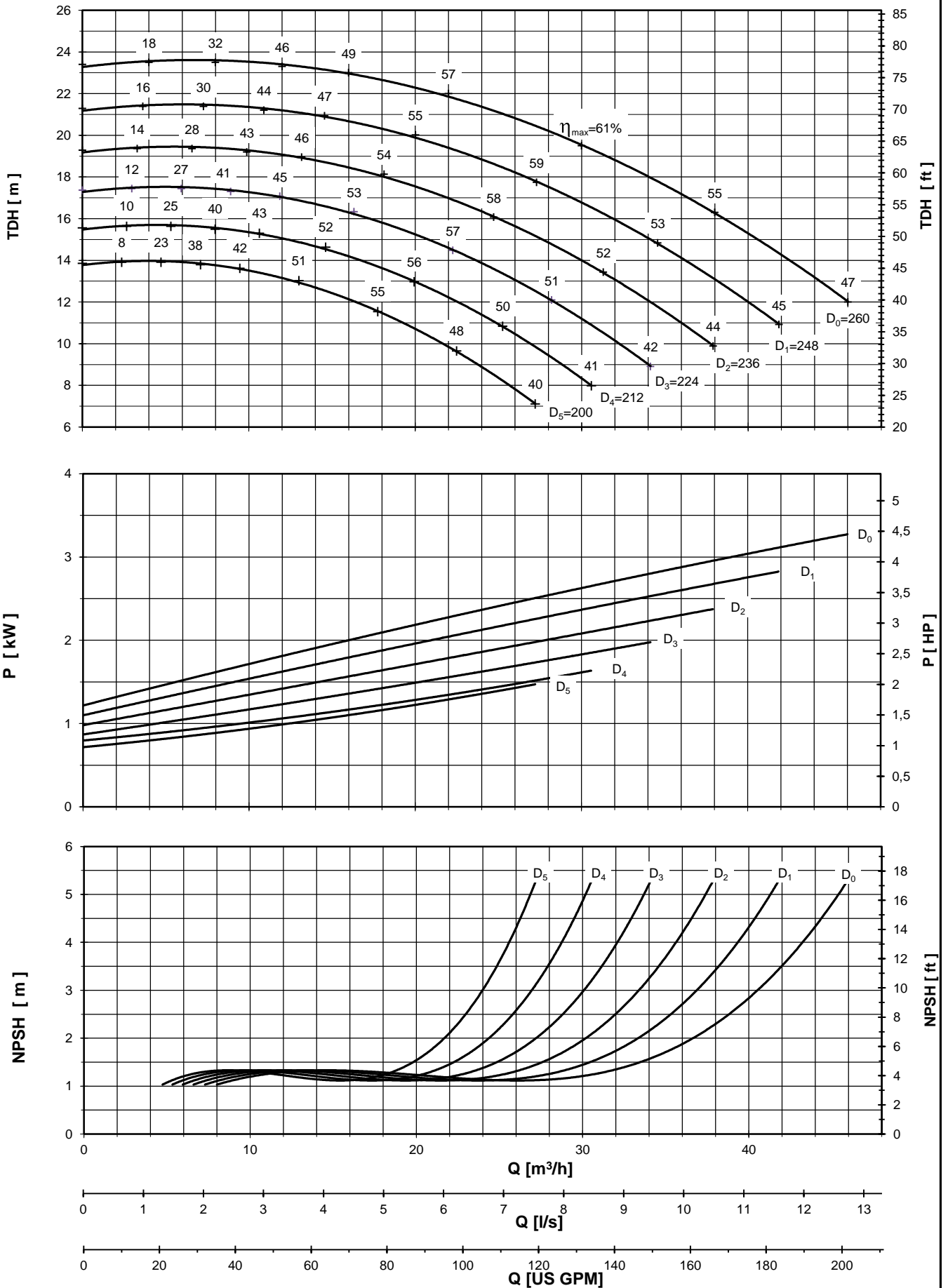

Performance curves are valid for clean cold water-kinematic viscosity 1 [mm²/s], density 1000 [kg/m³]. Methods and tolerances of presented performance curves are in accordance with ISO 9906 - Annex A

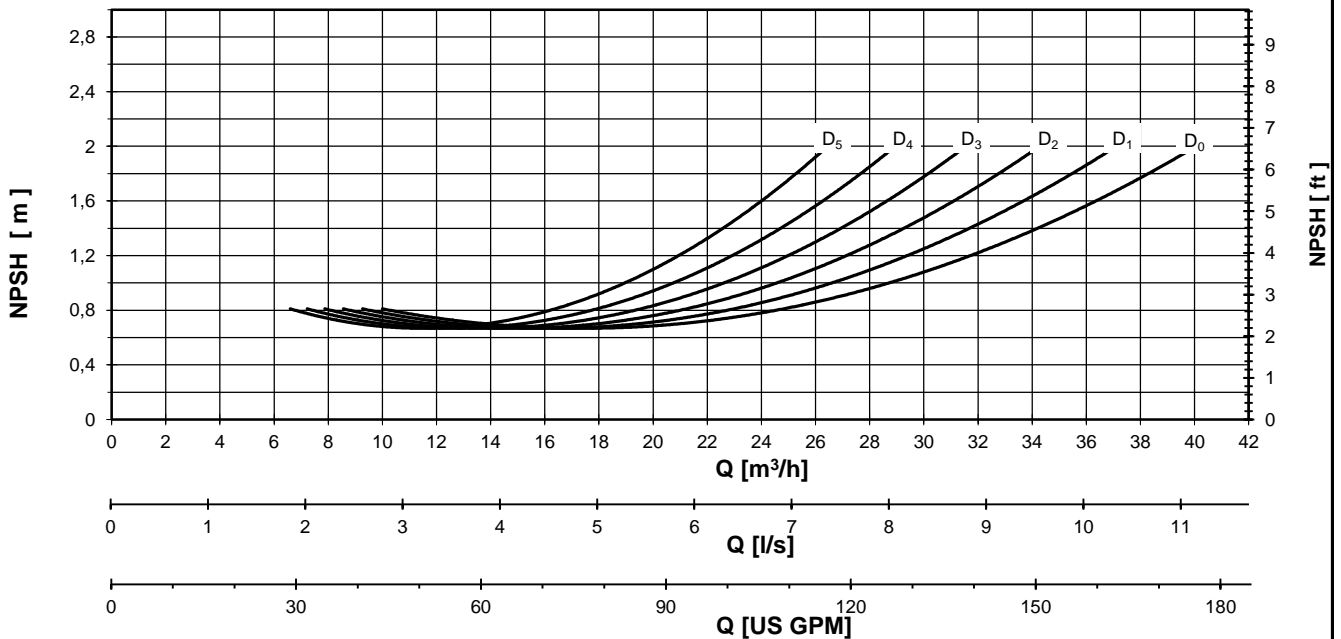
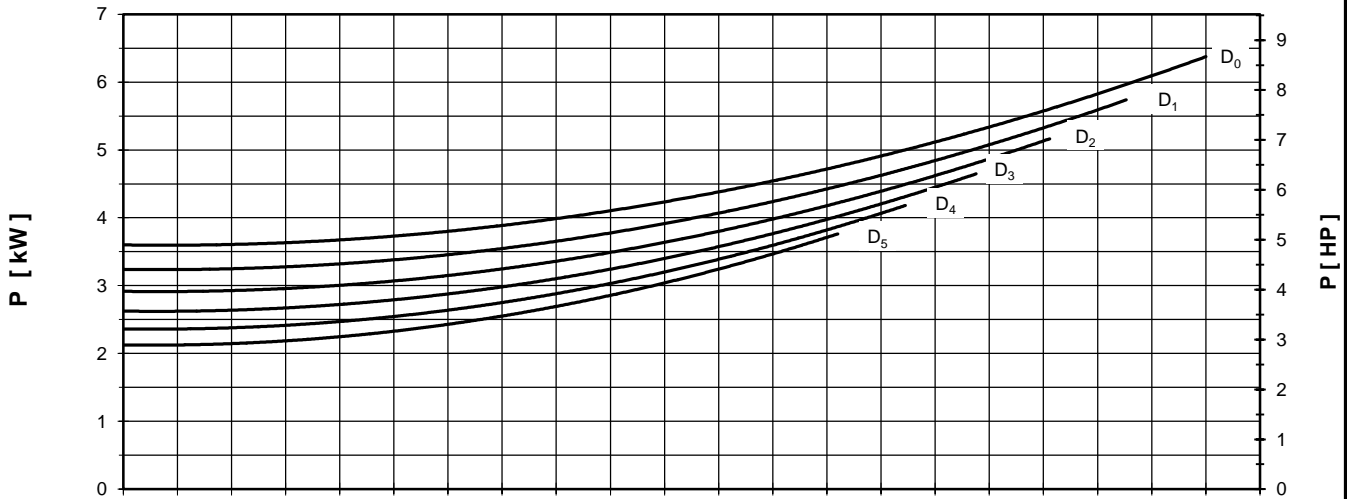
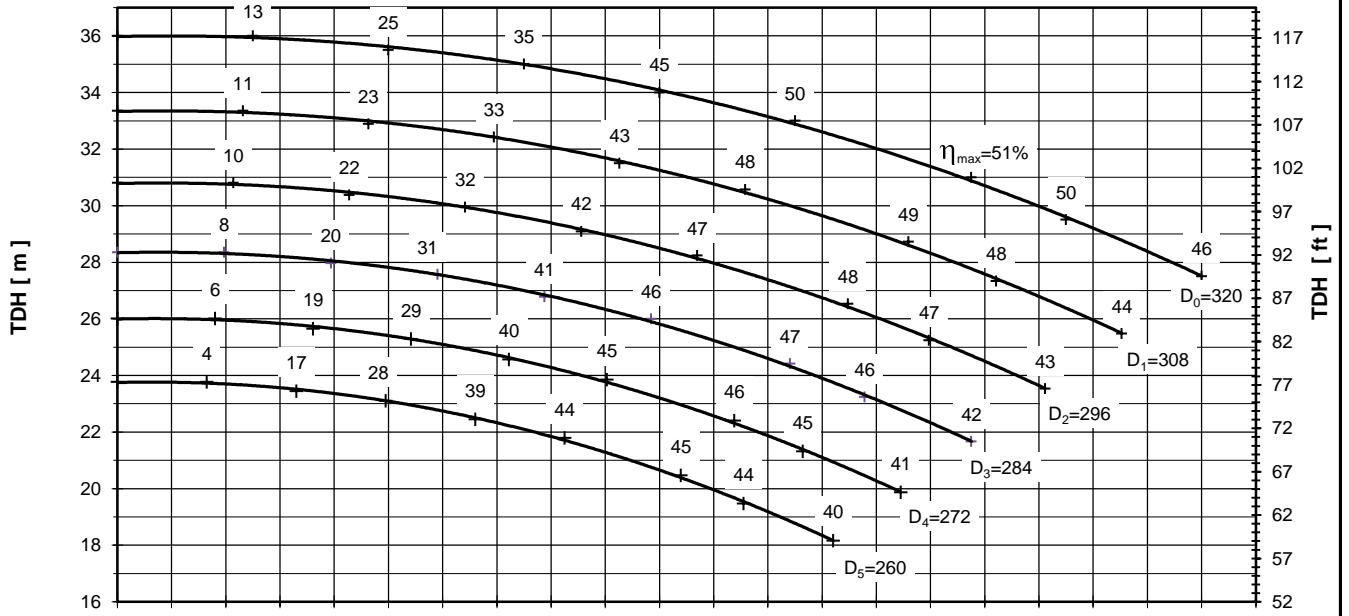

Performance curves are valid for clean cold water-kinematic viscosity 1 [mm²/s], density 1000 [kg/m³]. Methods and tolerances of presented performance curves are in accordance with ISO 9906 - Annex A

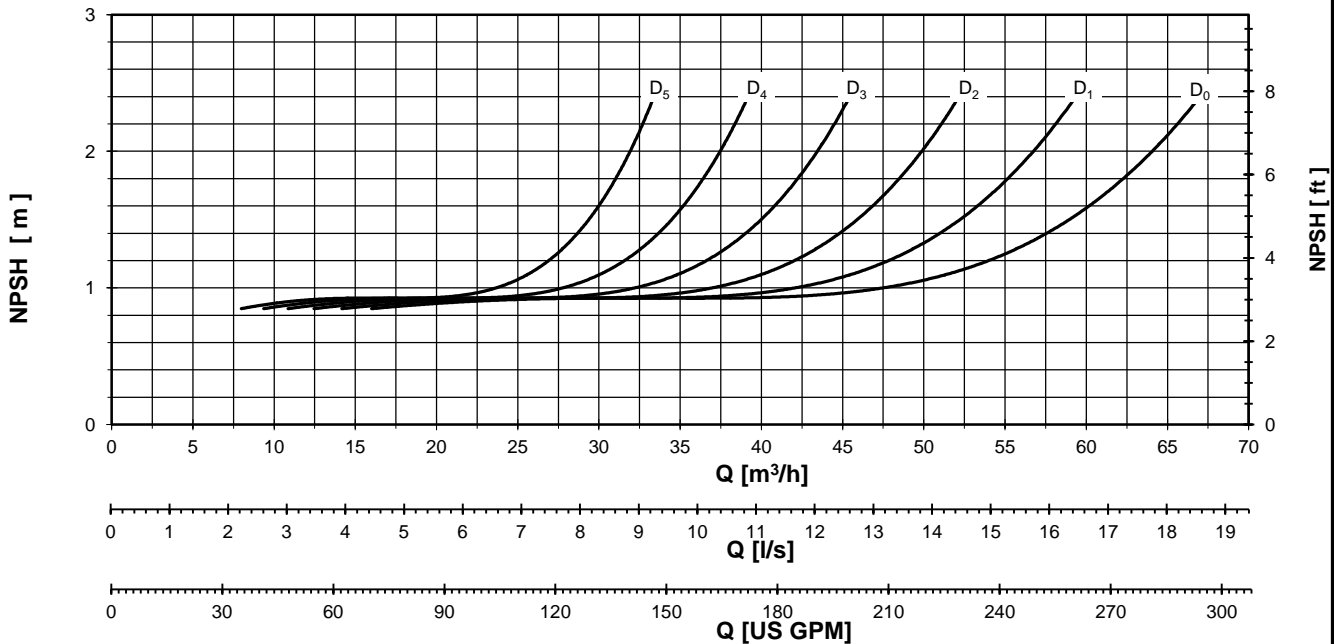
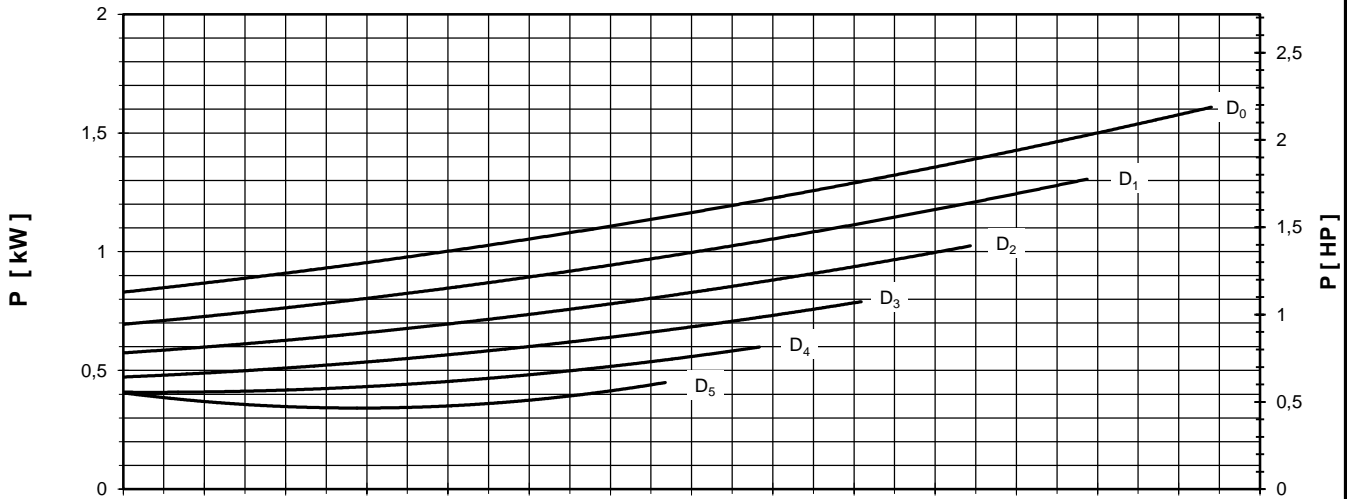
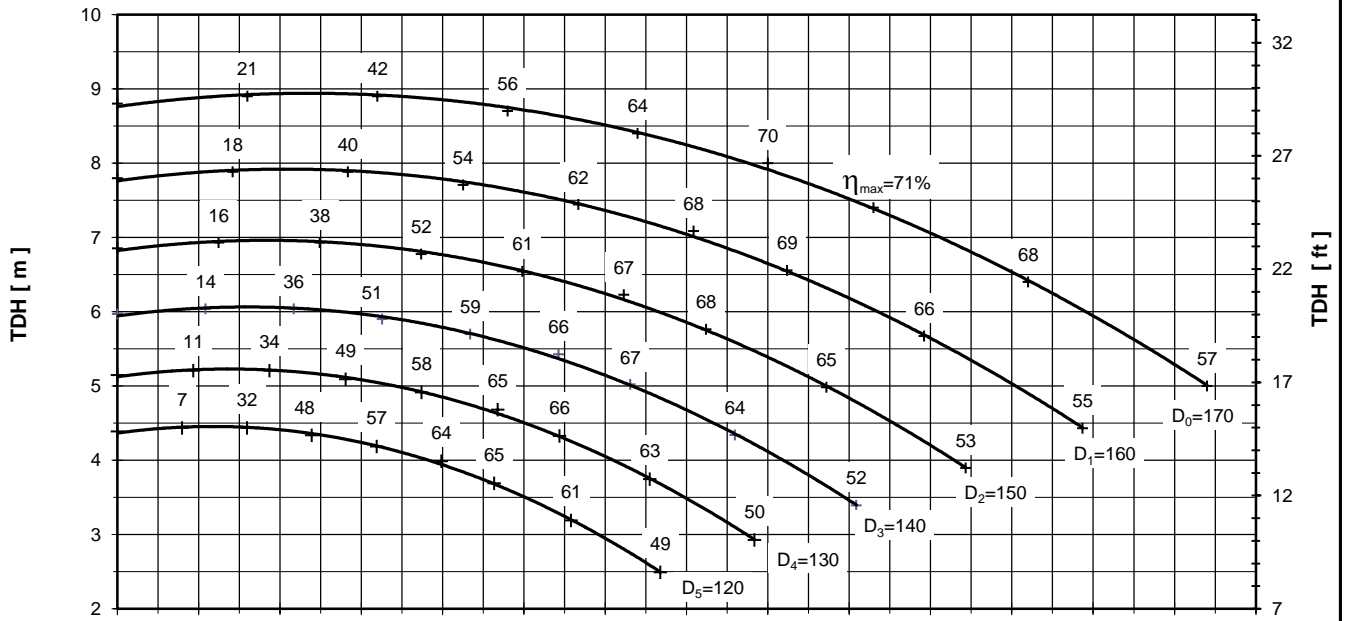

Performance curves are valid for clean cold water-kinematic viscosity 1 [mm²/s], density 1000 [kg/m³]. Methods and tolerances of presented performance curves are in accordance with ISO 9906 - Annex A

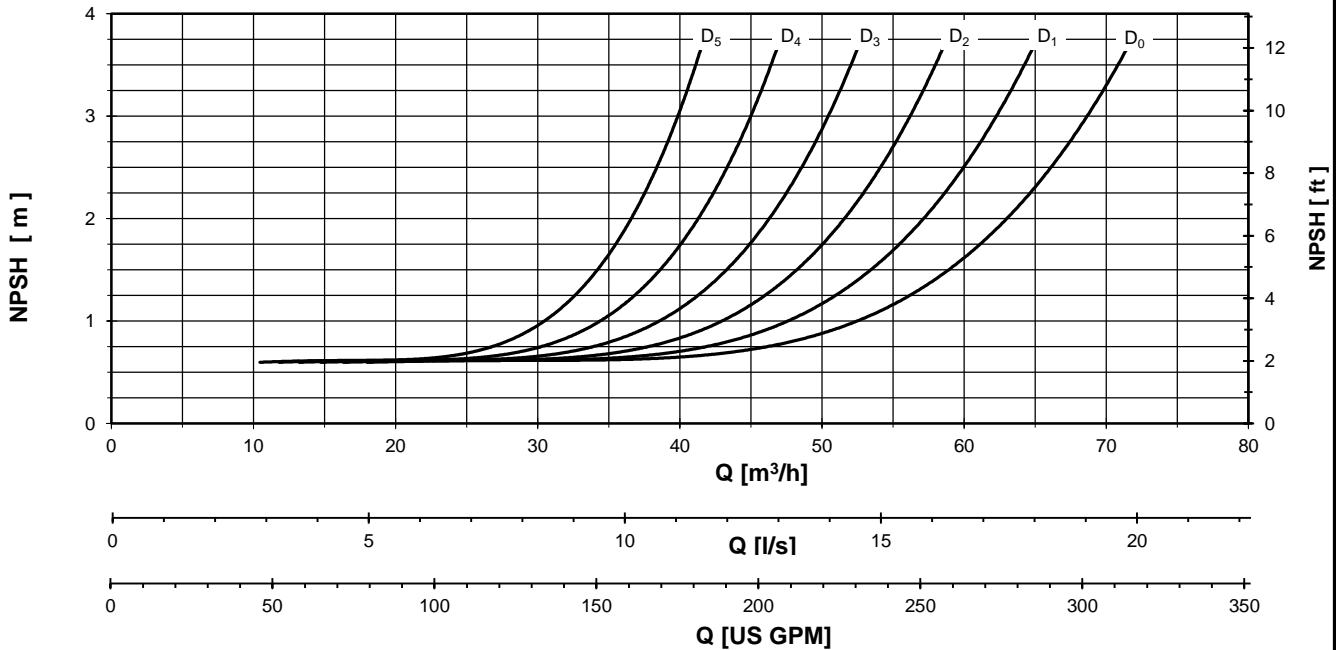
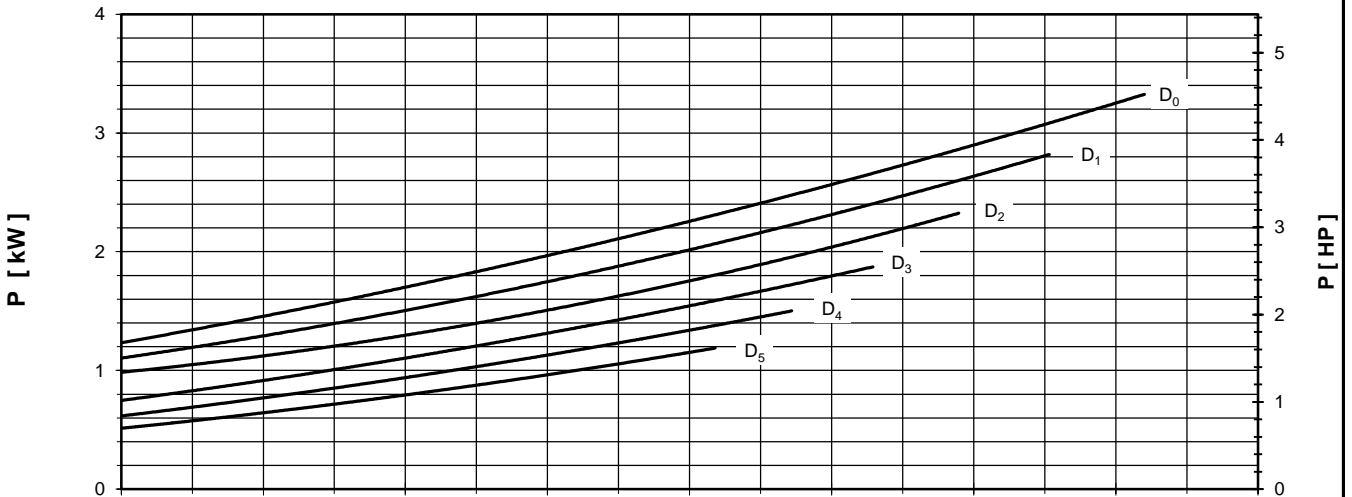
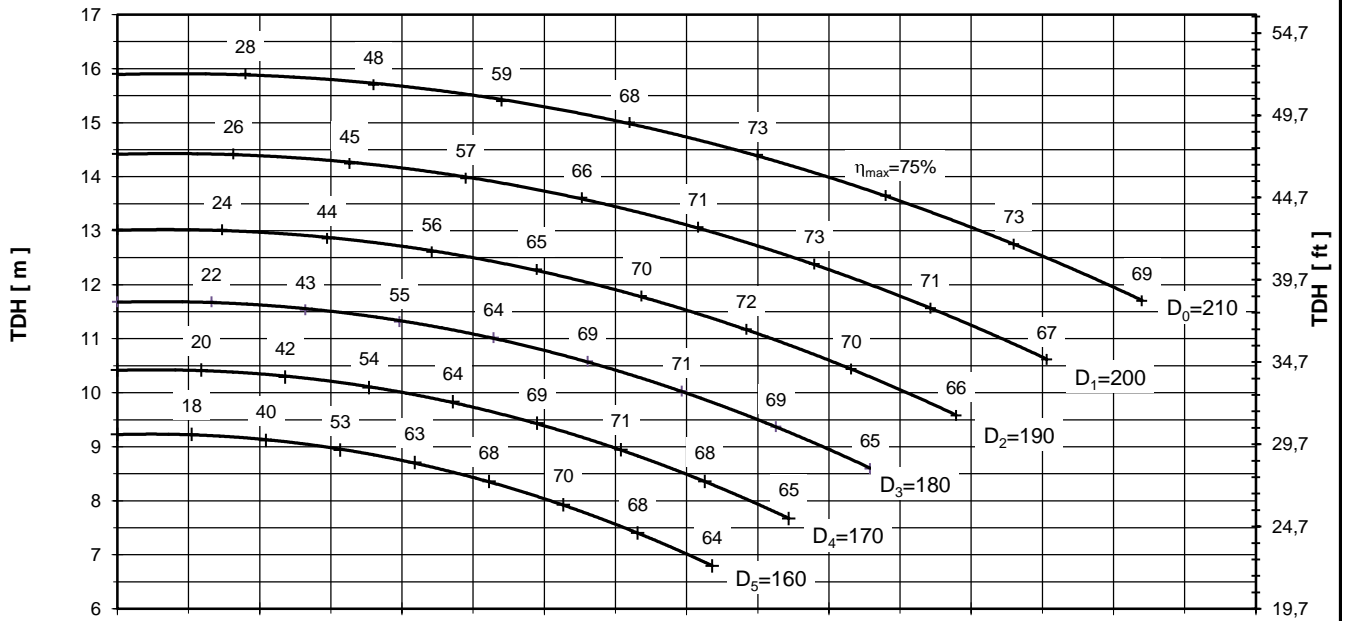

Performance curves are valid for clean cold water-kinematic viscosity 1 [mm²/s], density 1000 [kg/m³]. Methods and tolerances of presented performance curves are in accordance with ISO 9906 - Annex A

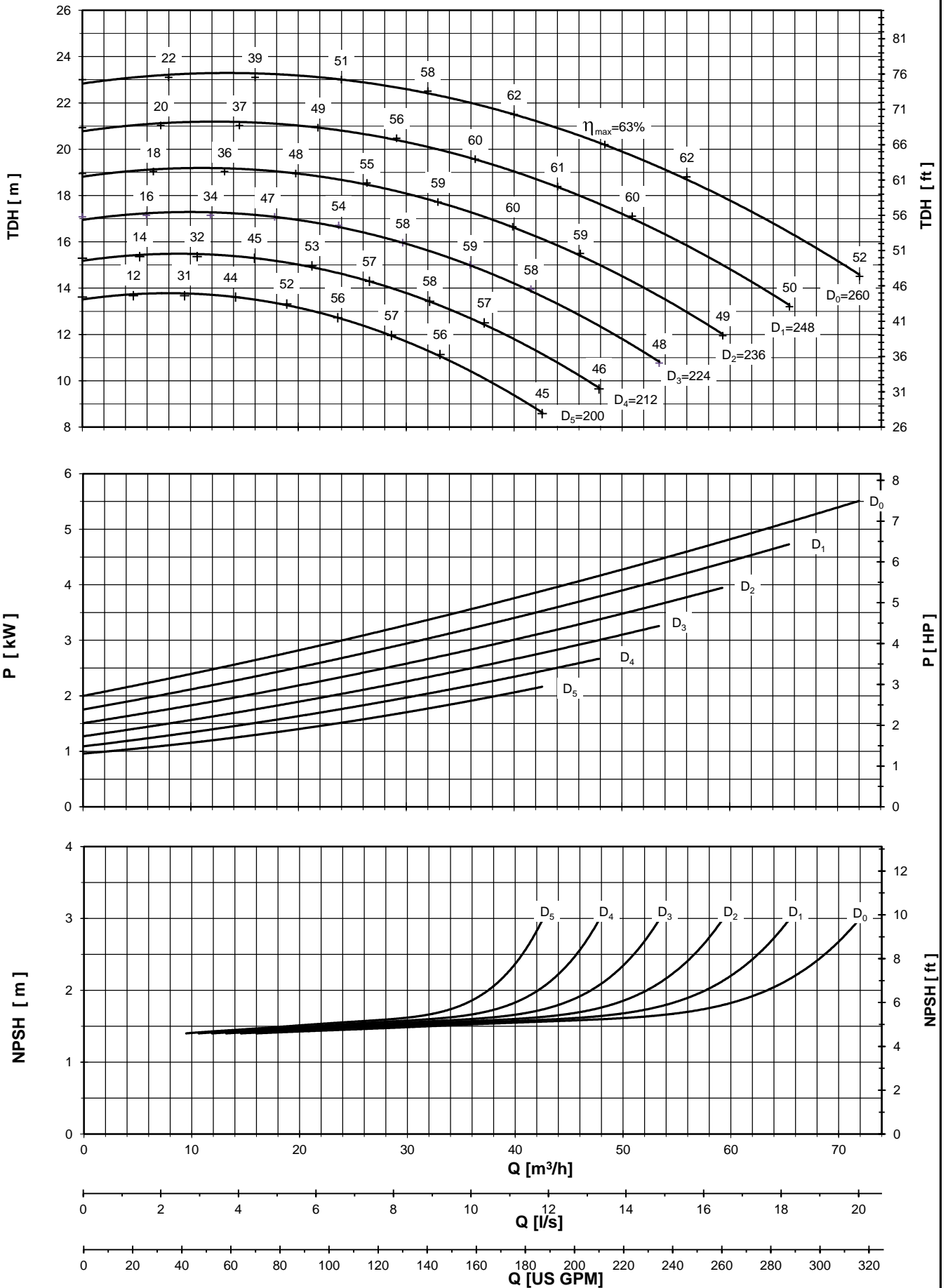

Performance curves are valid for clean cold water-kinematic viscosity 1 [mm²/s], density 1000 [kg/m³]. Methods and tolerances of presented performance curves are in accordance with ISO 9906 - Annex A

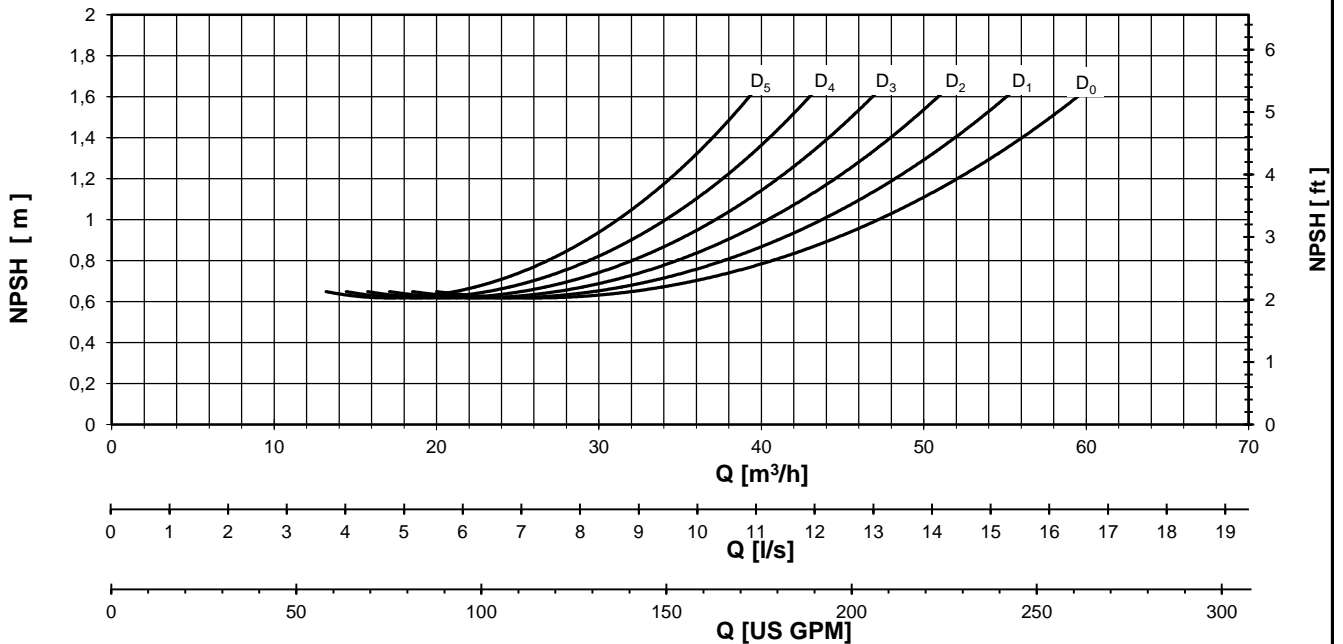
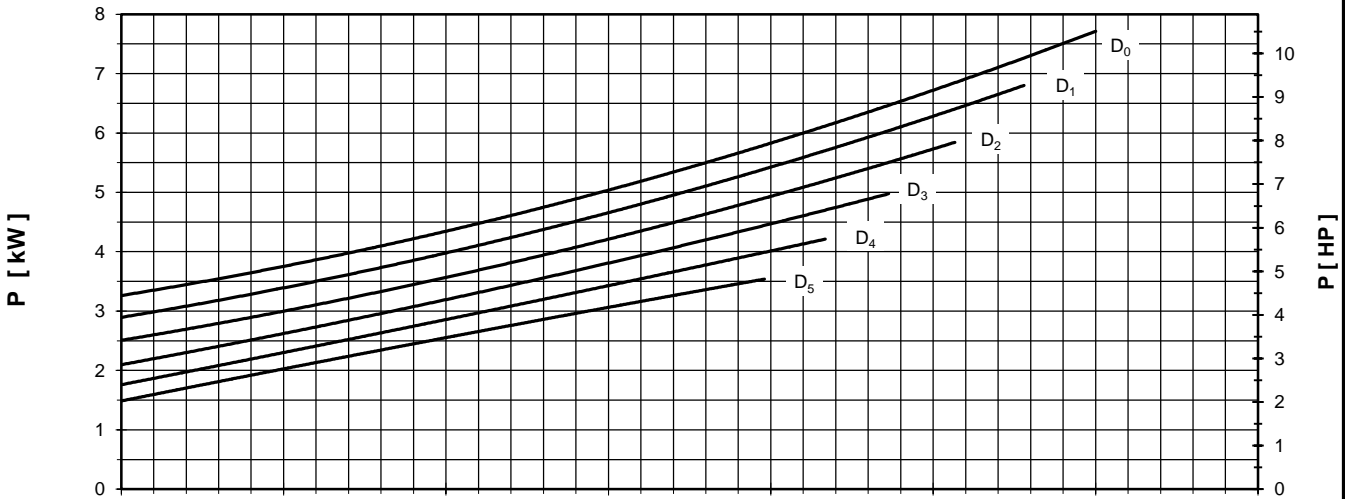
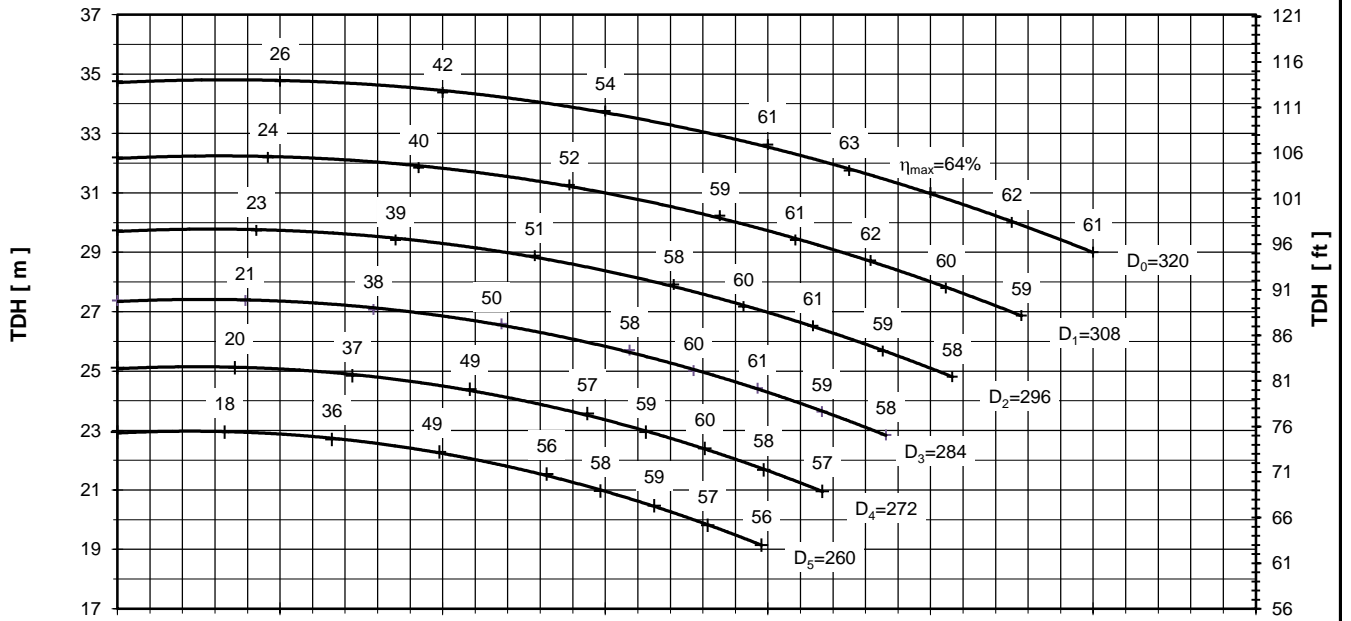

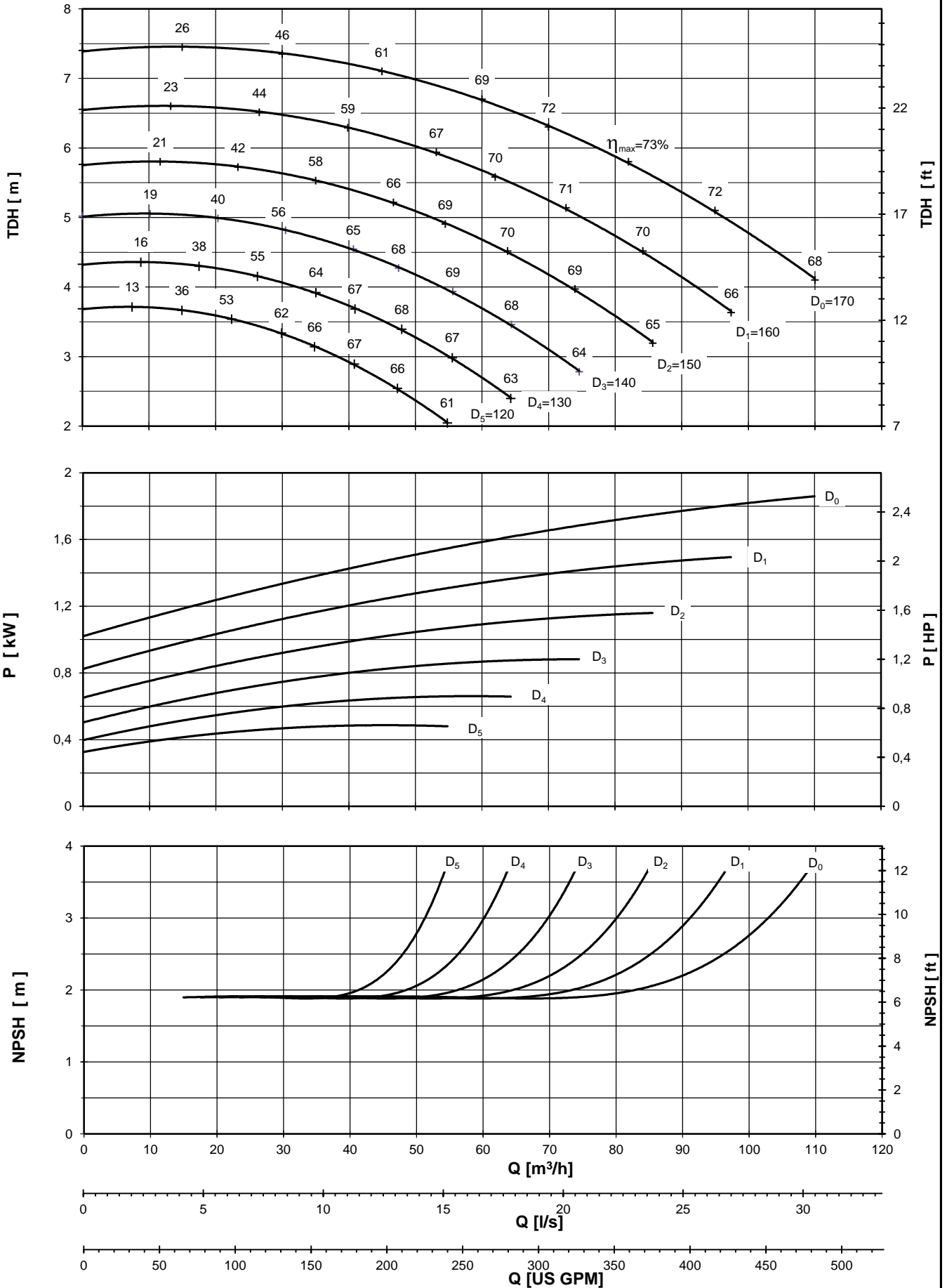

Performance curves are valid for clean cold water-kinematic viscosity 1 [mm²/s], density 1000 [kg/m³]. Methods and tolerances of presented performance curves are in accordance with ISO 9906 - Annex A



PUMP PERFORMANCE CURVES
No. 4HD.0161.03

PUMP TYPE
SCP 80 - 200
1450 [rpm]

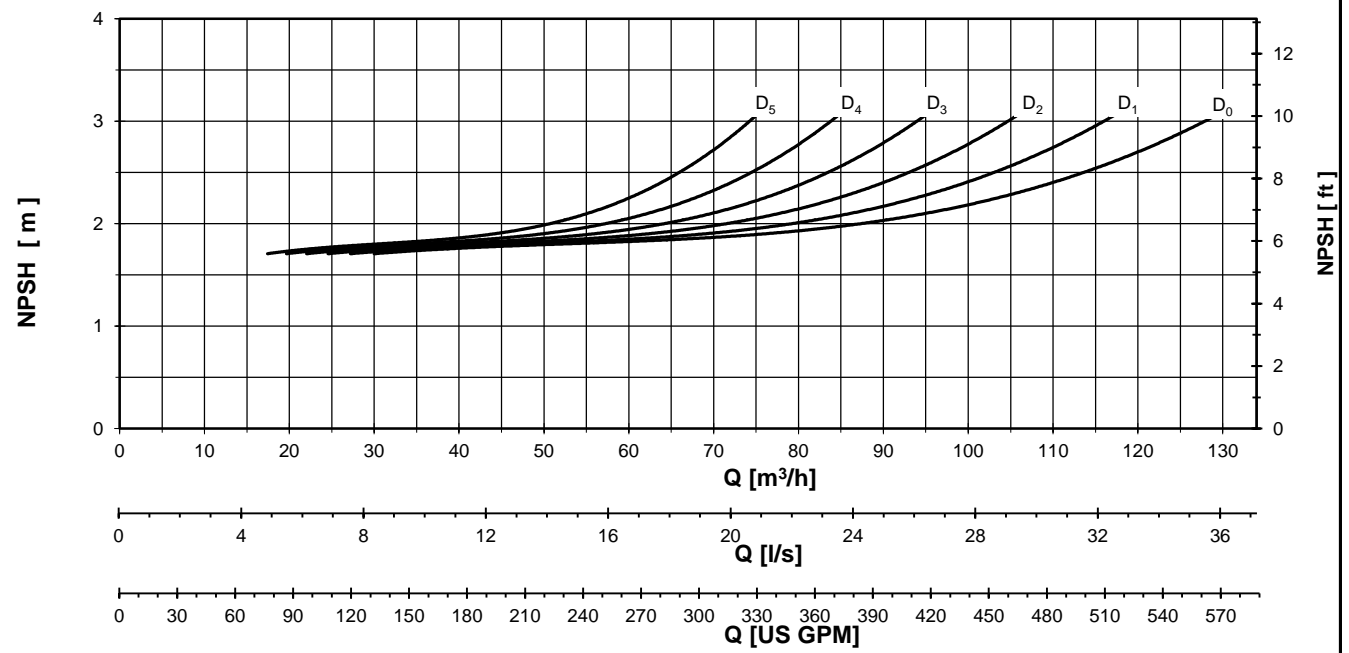
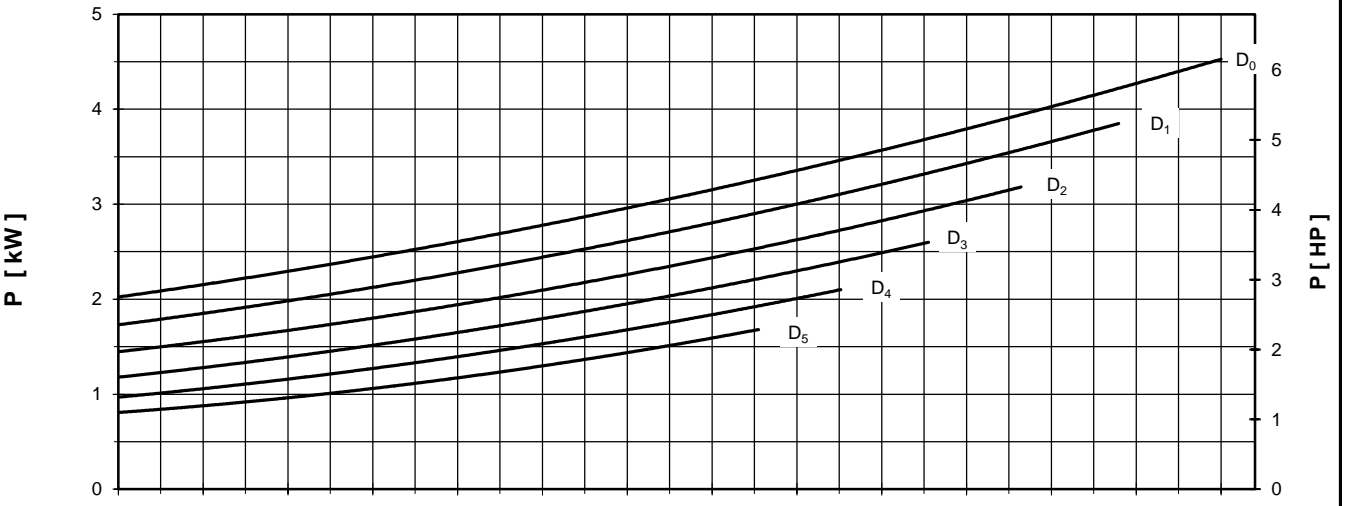
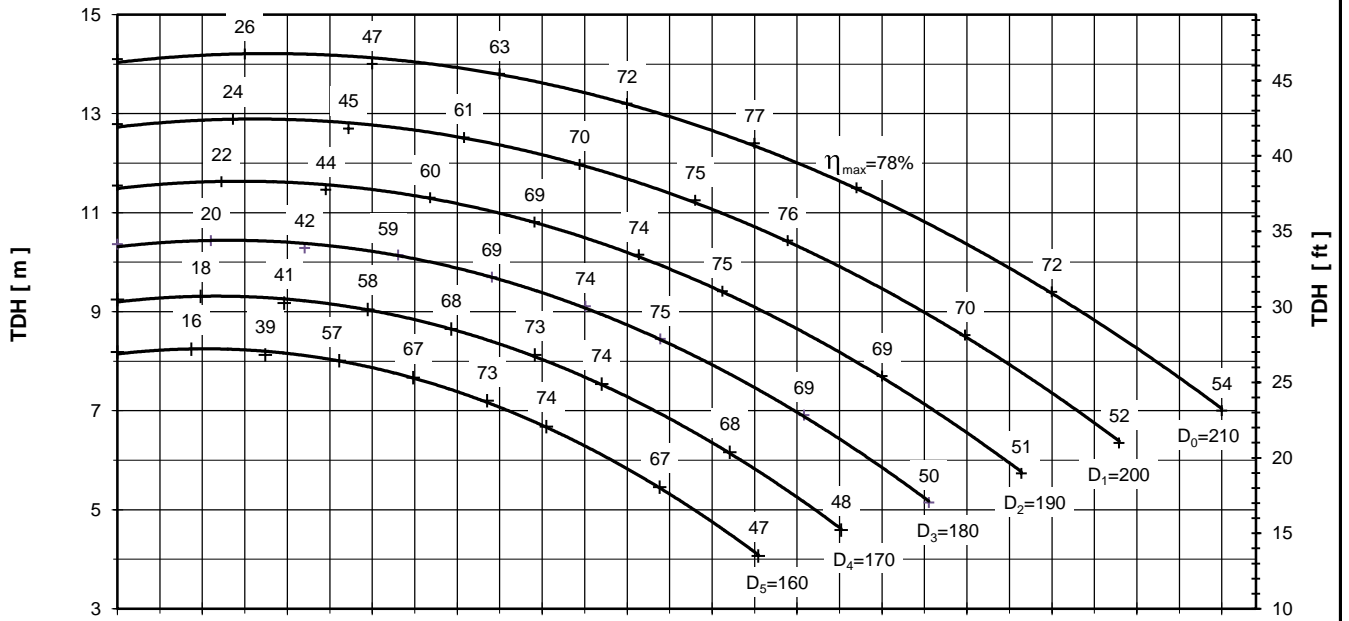

Performance curves are valid for clean cold water-kinematic viscosity 1 [mm²/s], density 1000 [kg/m³]. Methods and tolerances of presented performance curves are in accordance with ISO 9906 - Annex A

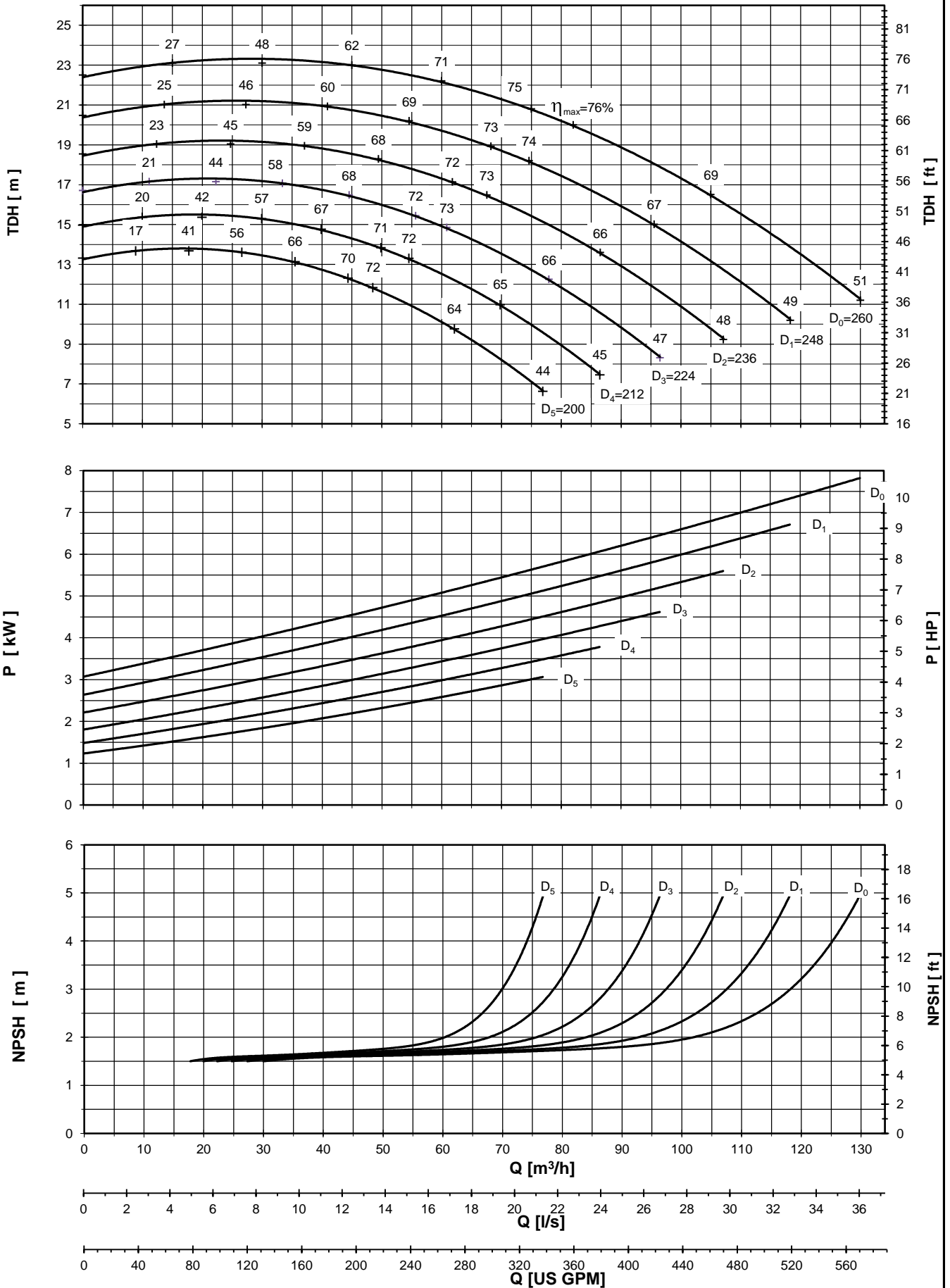

Performance curves are valid for clean cold water-kinematic viscosity 1 [mm²/s], density 1000 [kg/m³]. Methods and tolerances of presented performance curves are in accordance with ISO 9906 - Annex A



PUMP PERFORMANCE CURVES
No. 4HD.0163.03

PUMP TYPE
SCP 80 - 315
1450 [rpm]

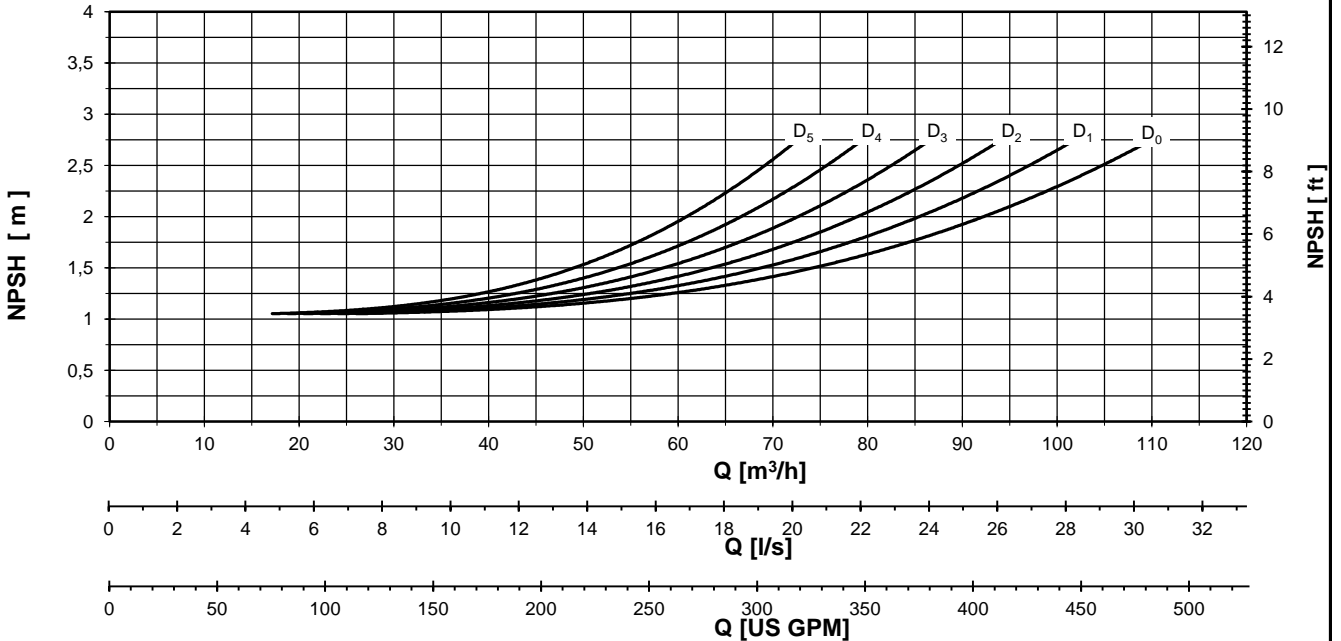
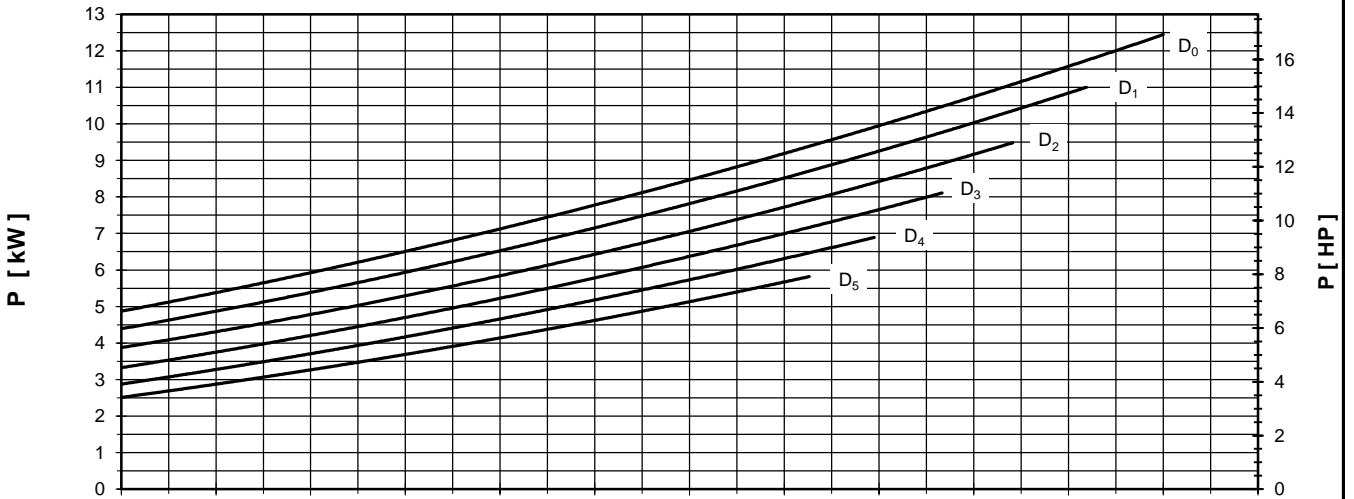
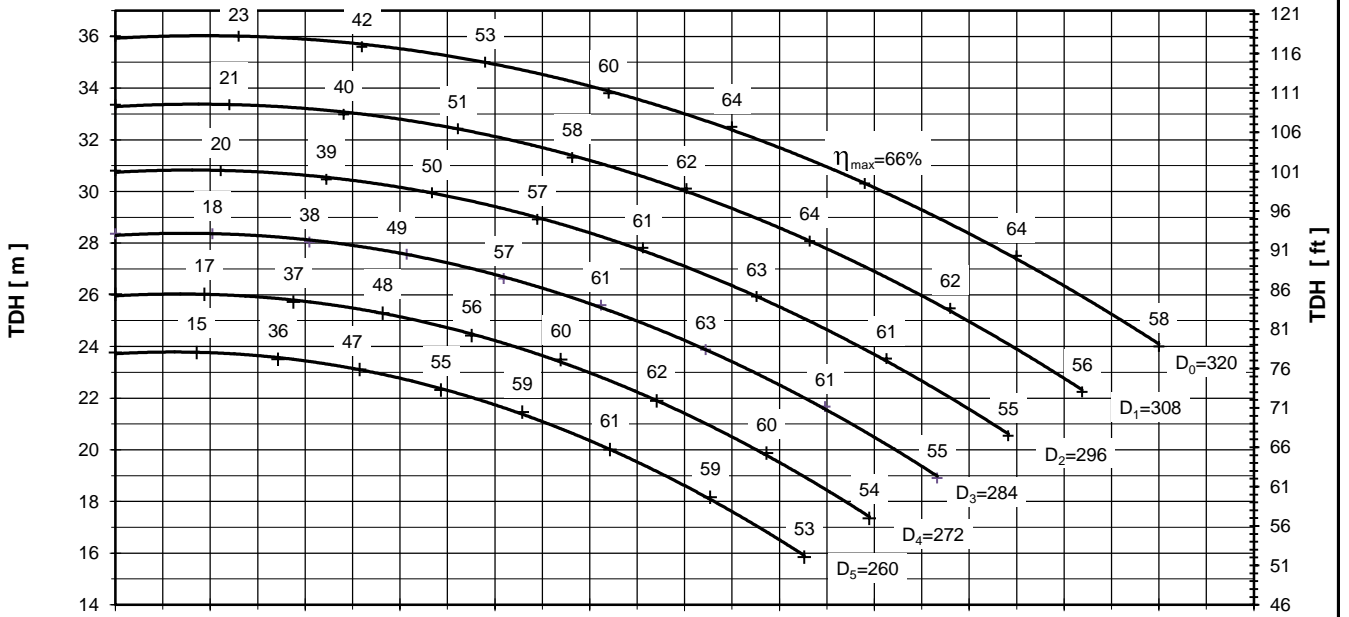

Performance curves are valid for clean cold water-kinematic viscosity 1 [mm²/s], density 1000 [kg/m³]. Methods and tolerances of presented performance curves are in accordance with ISO 9906 - Annex A



PUMP PERFORMANCE CURVES
No. 4HD.0164.03

PUMP TYPE
SCP 80 - 400
1450 [rpm]

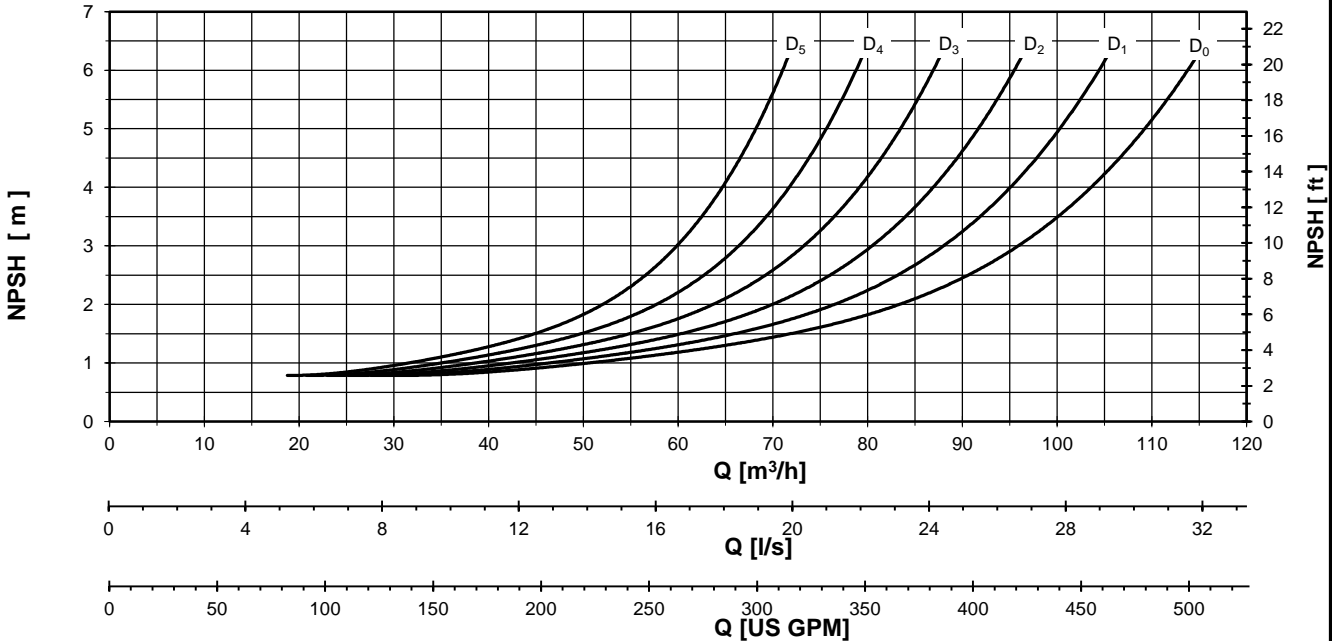
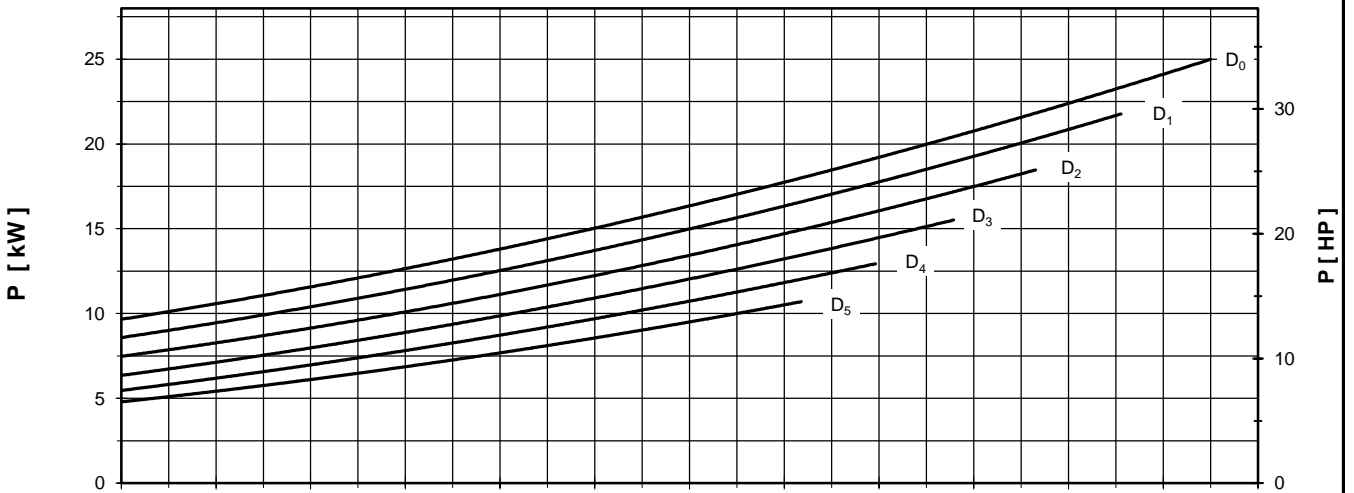
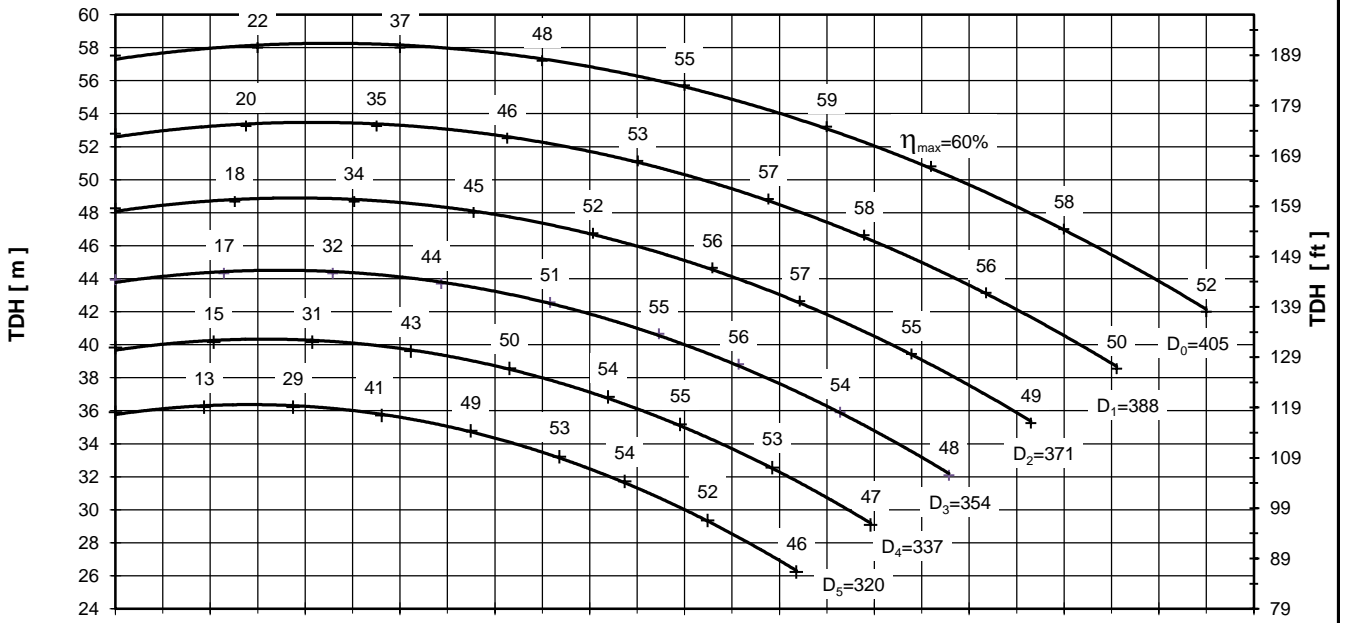

Performance curves are valid for clean cold water-kinematic viscosity 1 [mm²/s], density 1000 [kg/m³]. Methods and tolerances of presented performance curves are in accordance with ISO 9906 - Annex A

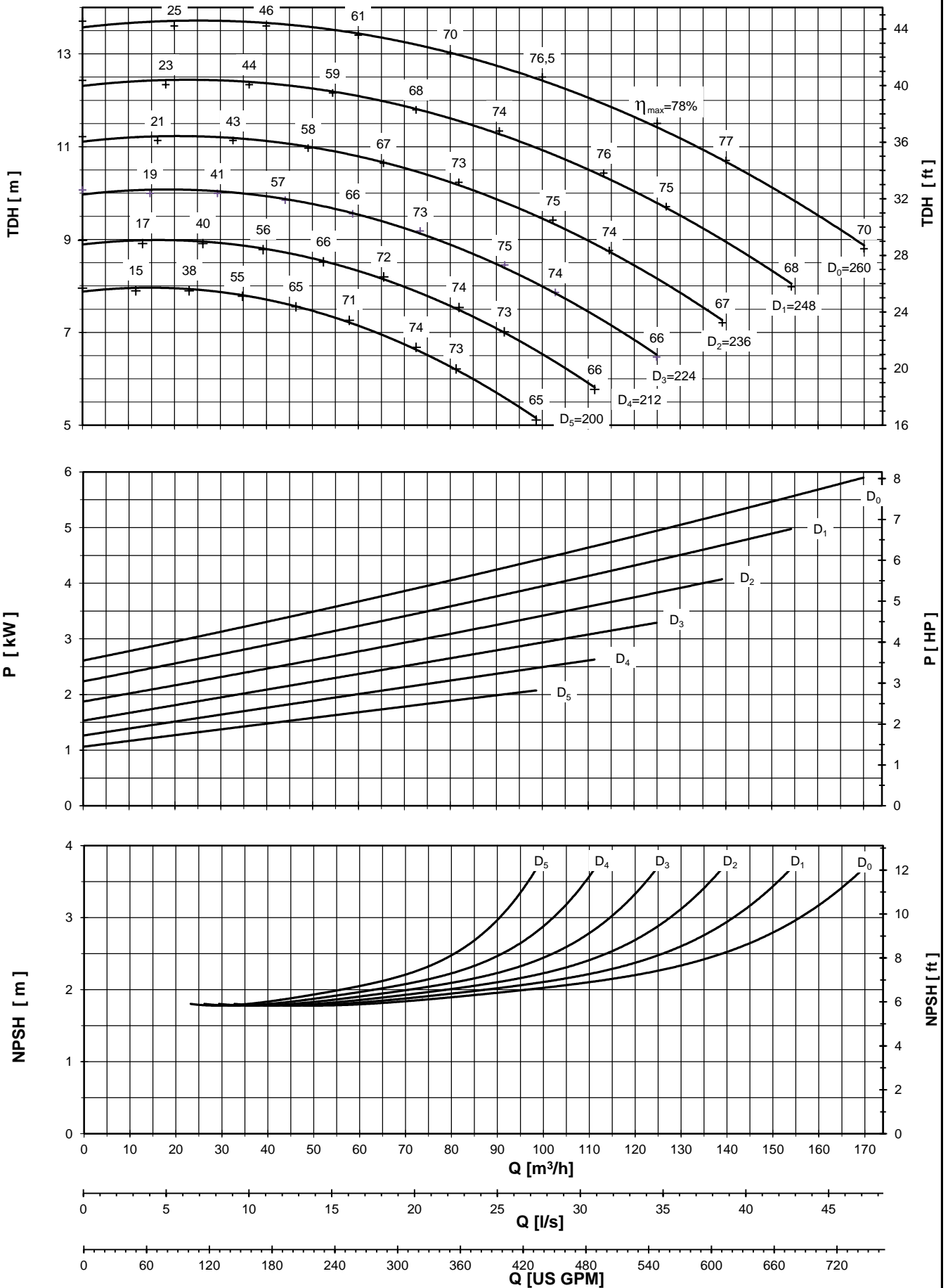

Performance curves are valid for clean cold water-kinematic viscosity 1 [mm²/s], density 1000 [kg/m³]. Methods and tolerances of presented performance curves are in accordance with ISO 9906 - Annex A



PUMP PERFORMANCE CURVES
No. 4HD.0166.03

PUMP TYPE
SCP 100 - 250
1450 [rpm]

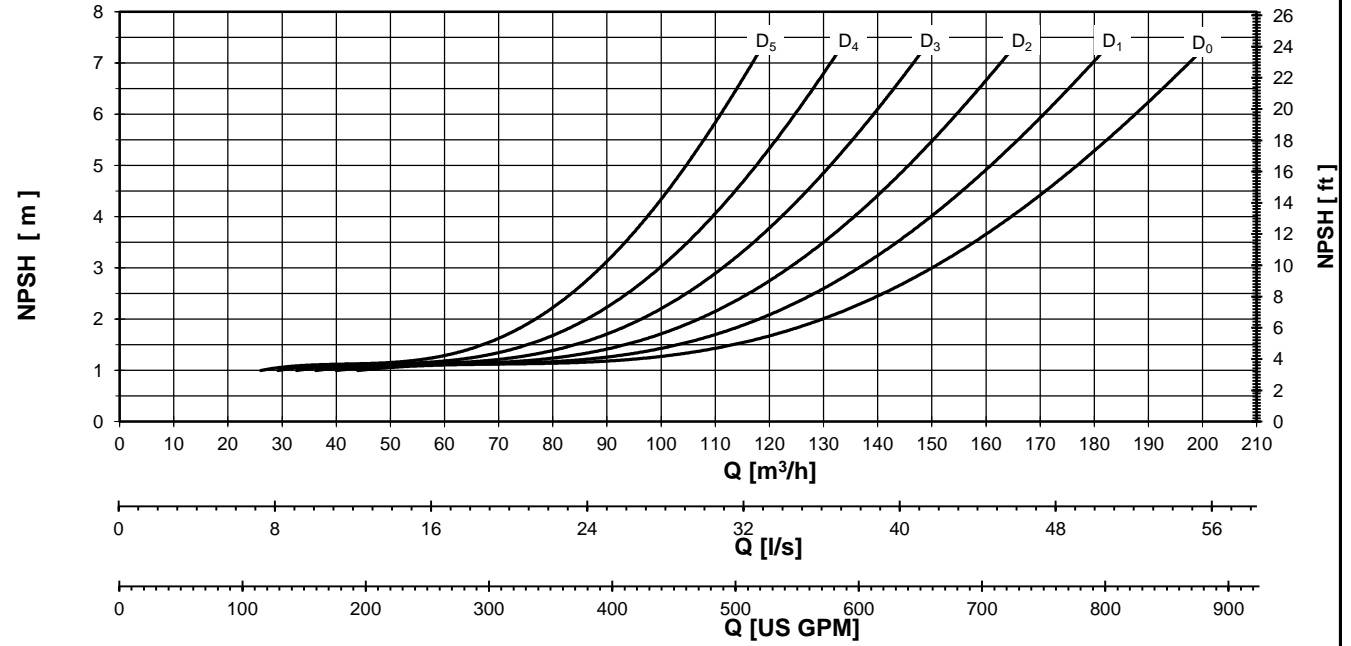
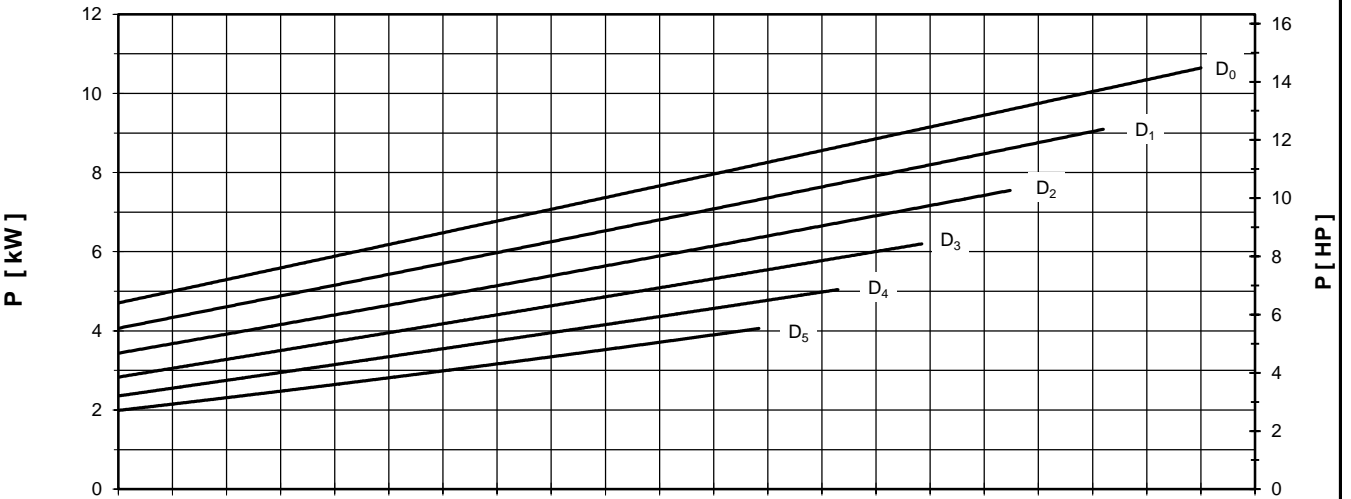
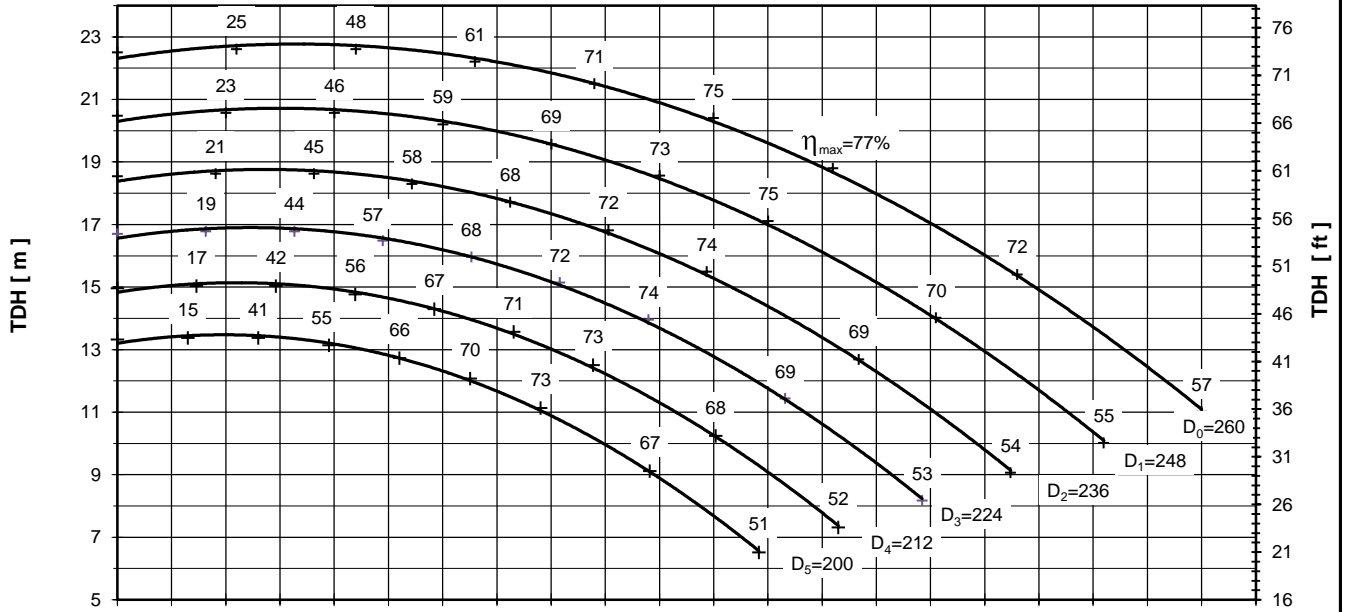

Performance curves are valid for clean cold water-kinematic viscosity 1 [mm²/s], density 1000 [kg/m³]. Methods and tolerances of presented performance curves are in accordance with ISO 9906 - Annex A

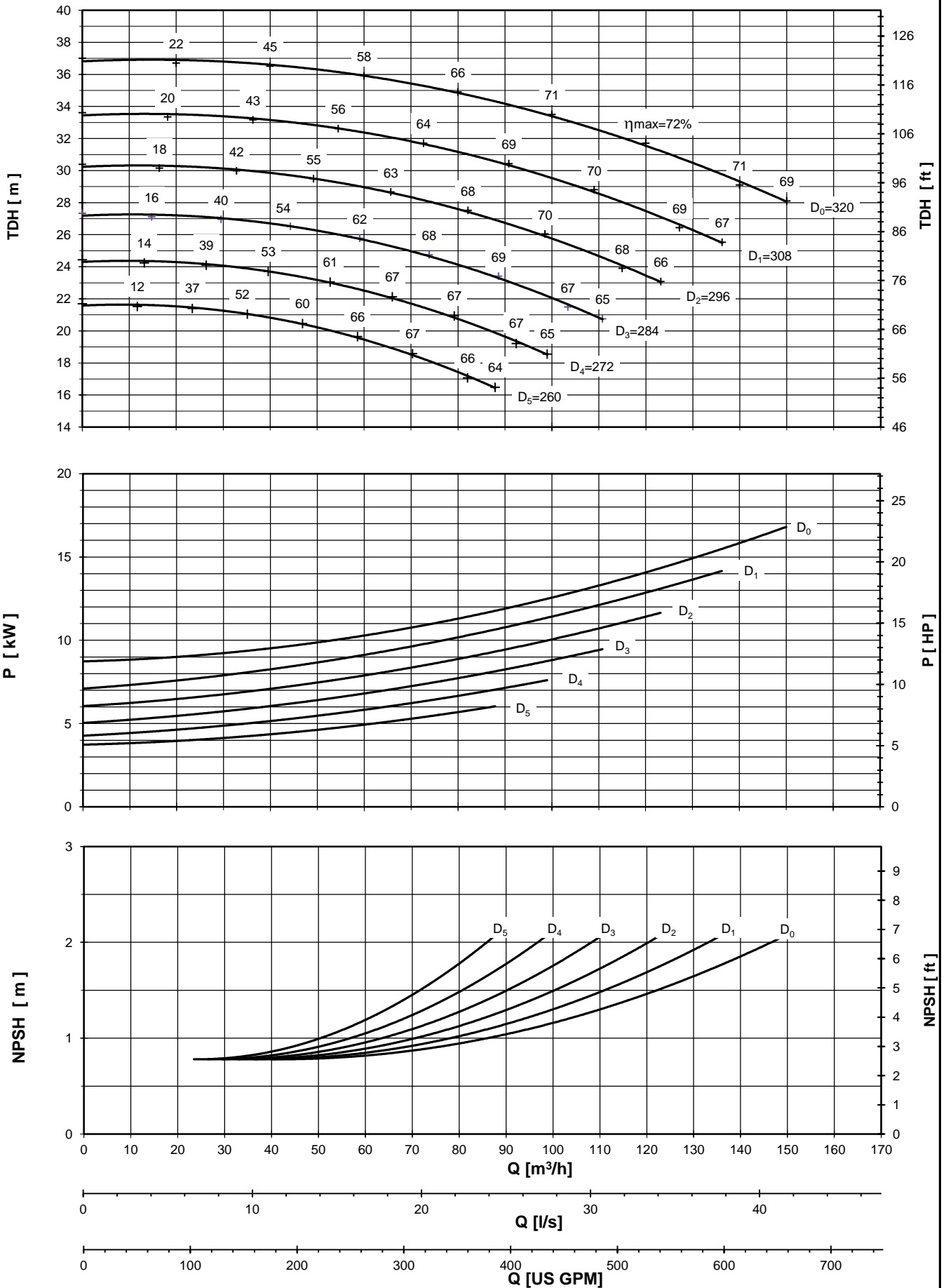

Performance curves are valid for clean cold water-kinematic viscosity 1 [mm²/s], density 1000 [kg/m³]. Methods and tolerances of presented performance curves are in accordance with ISO 9906 - Annex A

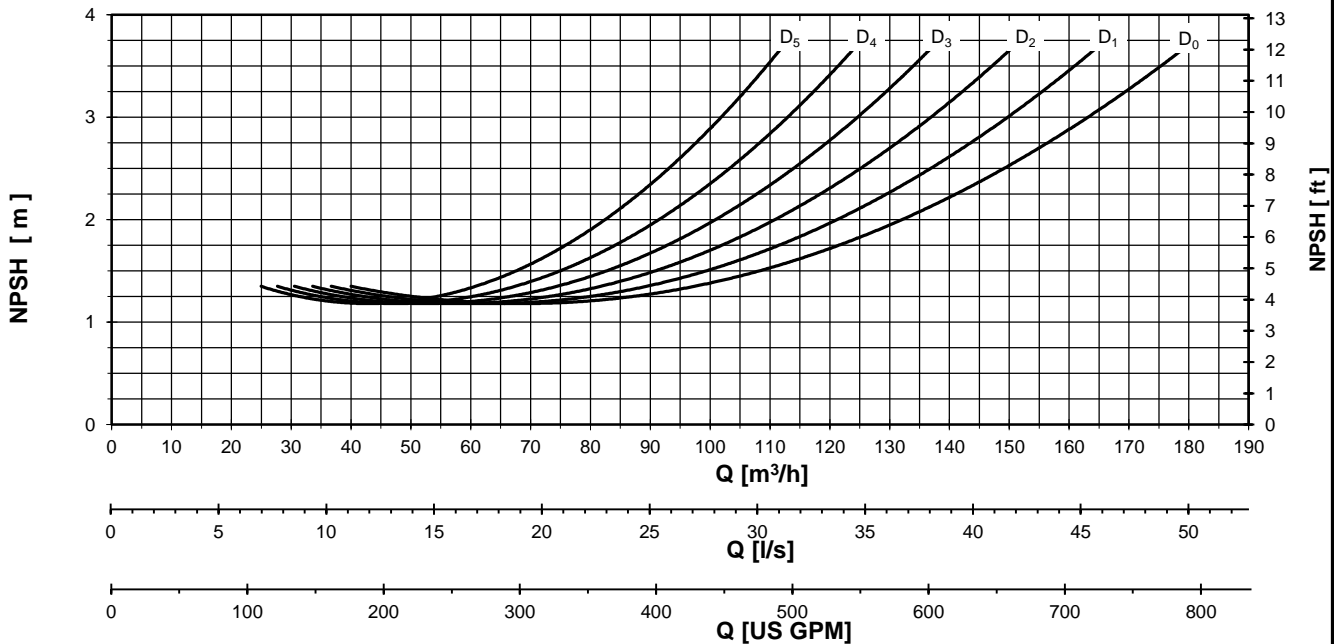
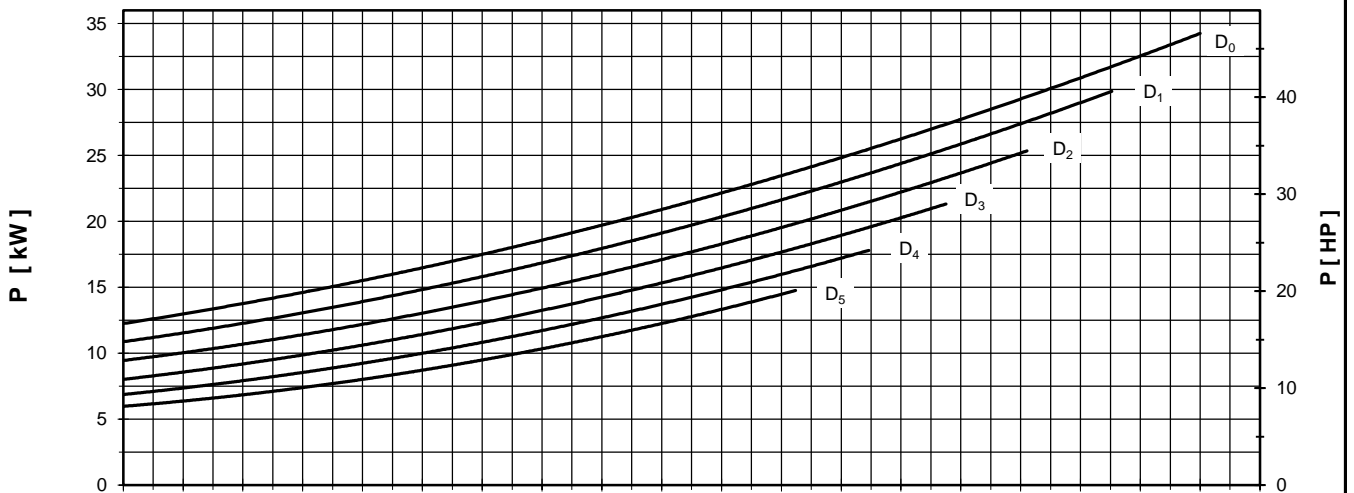
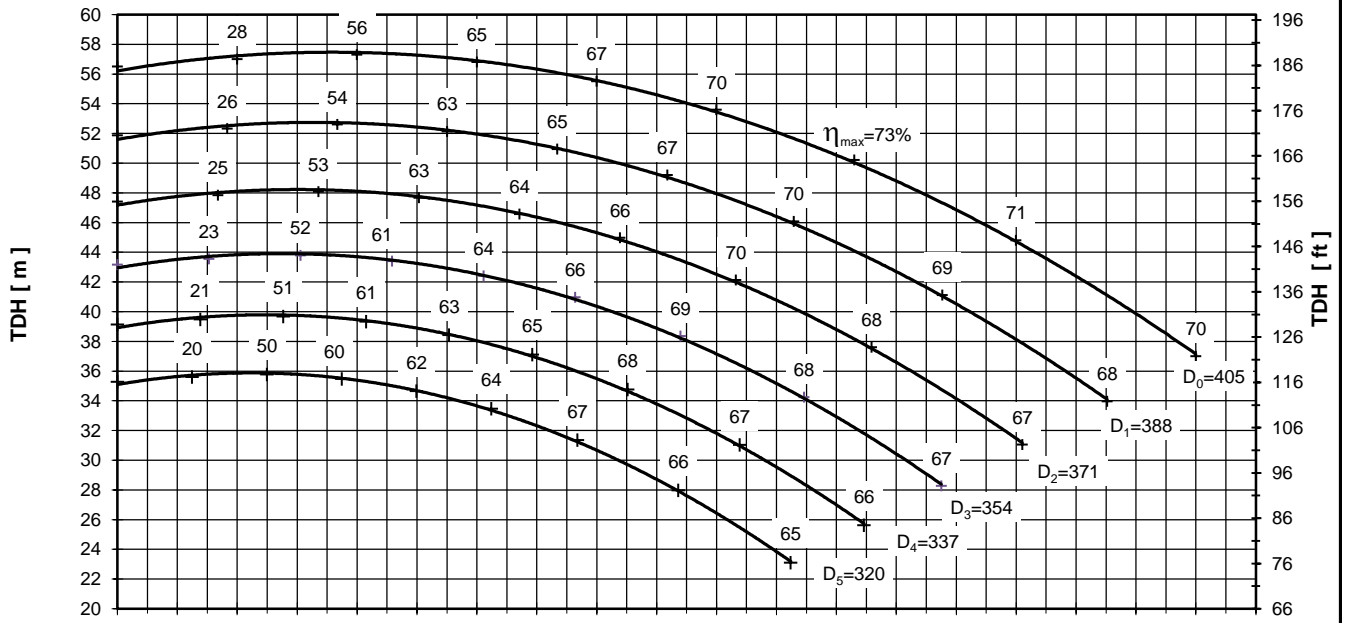

Performance curves are valid for clean cold water-kinematic viscosity 1 [mm²/s], density 1000 [kg/m³]. Methods and tolerances of presented performance curves are in accordance with ISO 9906 - Annex A



PUMP PERFORMANCE CURVES
No. 4HD.0169.03

PUMP TYPE
SCP 125 - 250
1450 [rpm]

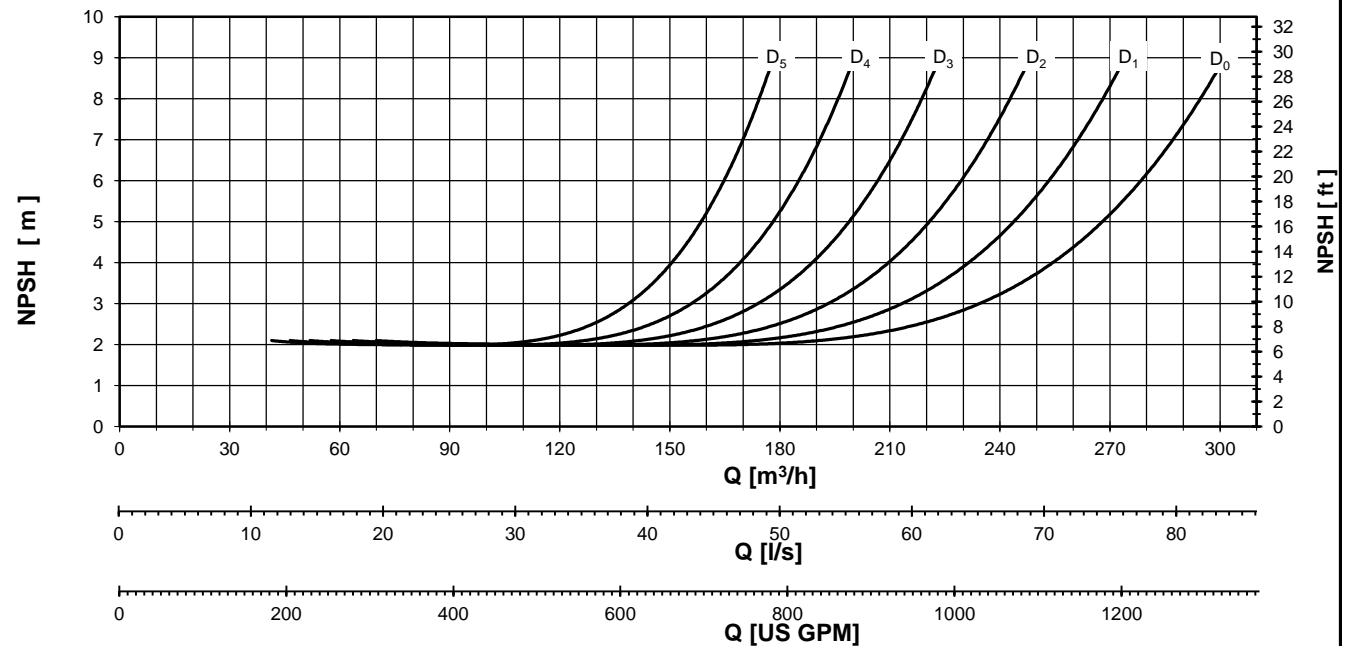
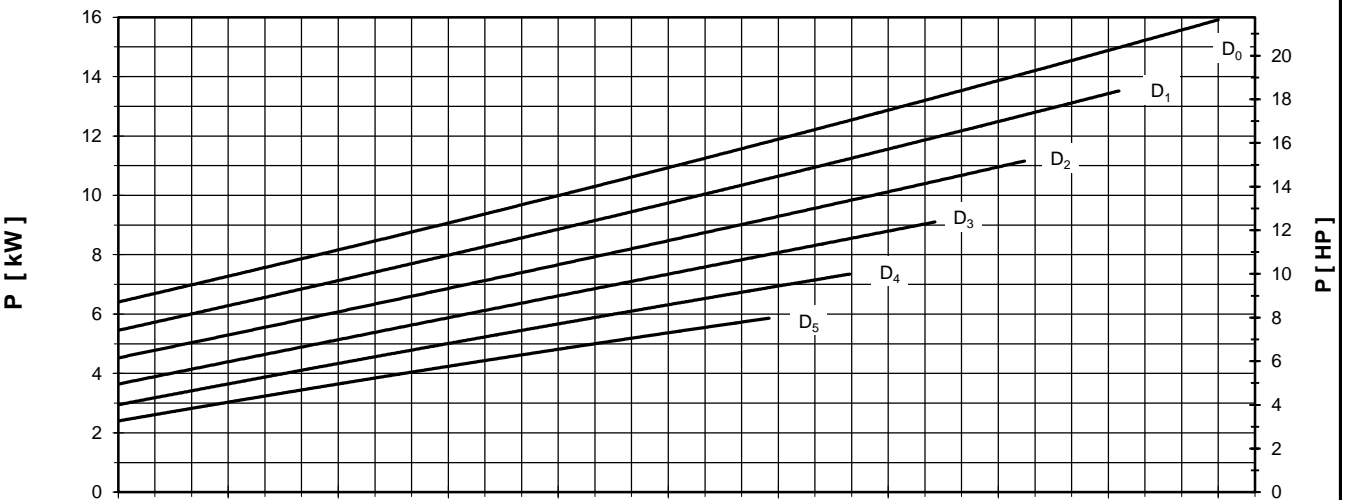
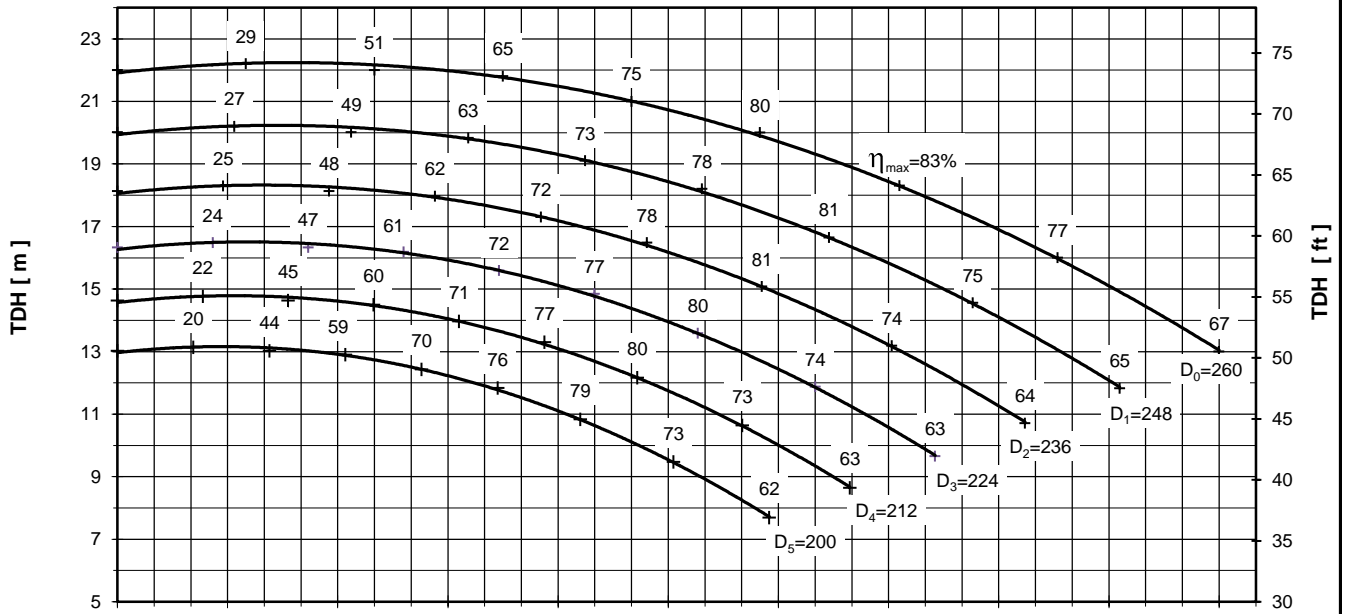

Performance curves are valid for clean cold water-kinematic viscosity 1 [mm²/s], density 1000 [kg/m³]. Methods and tolerances of presented performance curves are in accordance with ISO 9906 - Annex A



PUMP PERFORMANCE CURVES
No. 4HD.0170.03

PUMP TYPE
SCP 125 - 315
1450 [rpm]

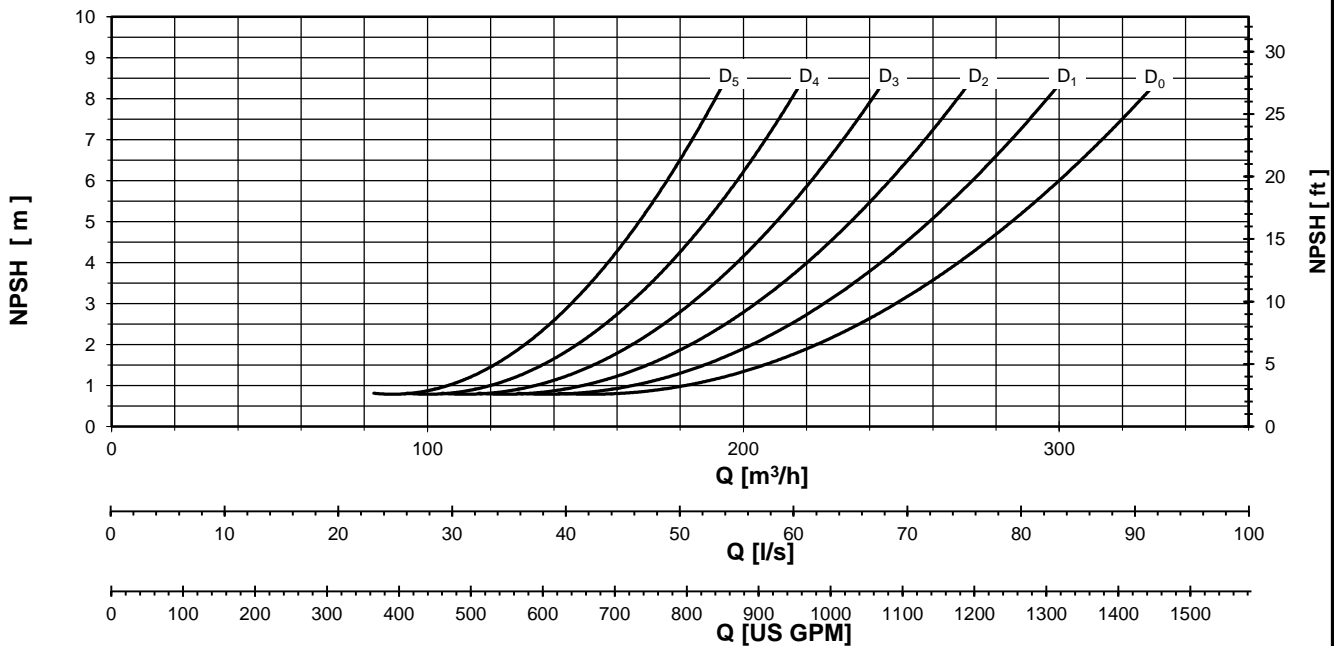
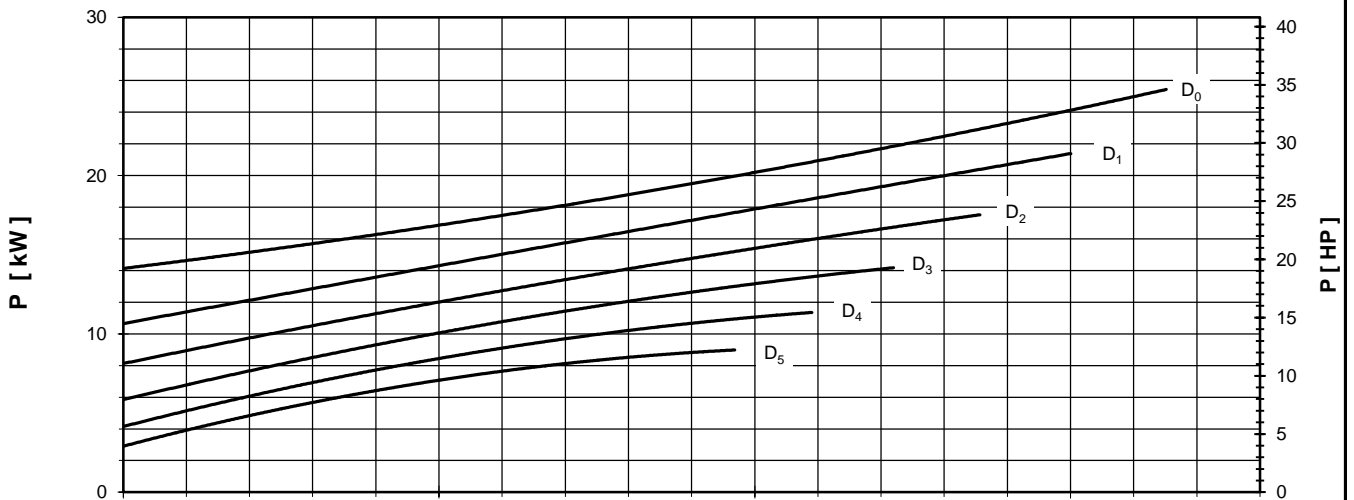
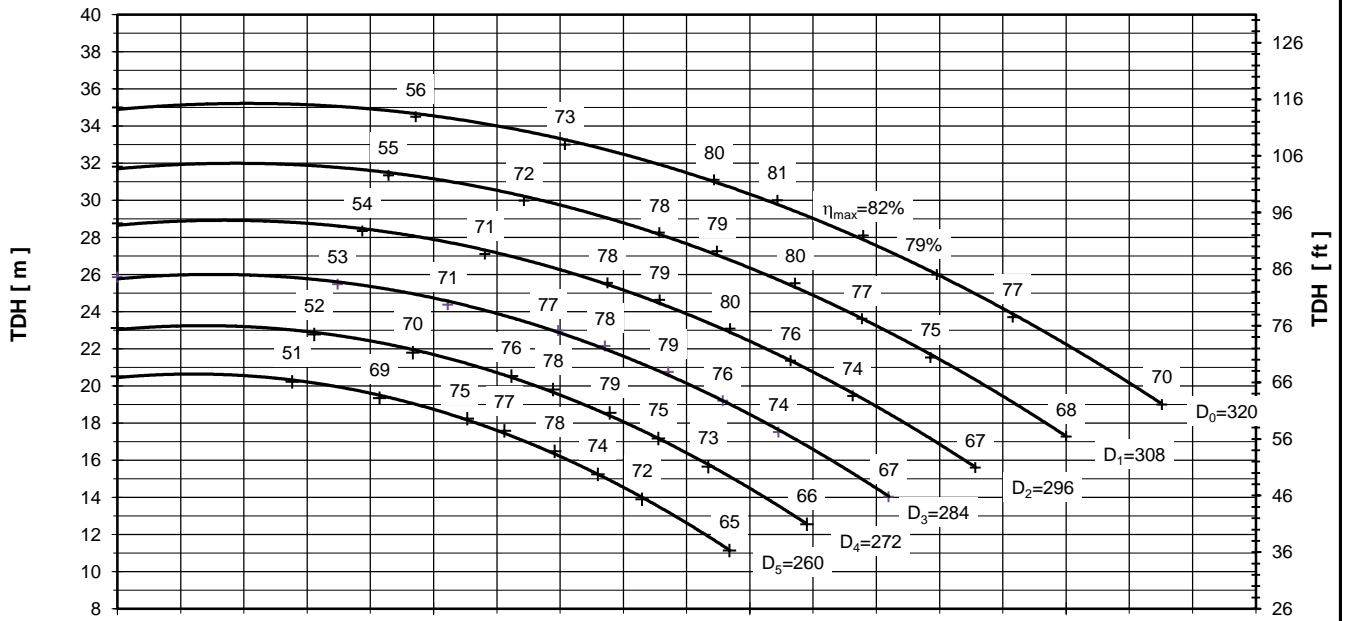

Performance curves are valid for clean cold water-kinematic viscosity 1 [mm²/s], density 1000 [kg/m³]. Methods and tolerances of presented performance curves are in accordance with ISO 9906 - Annex A

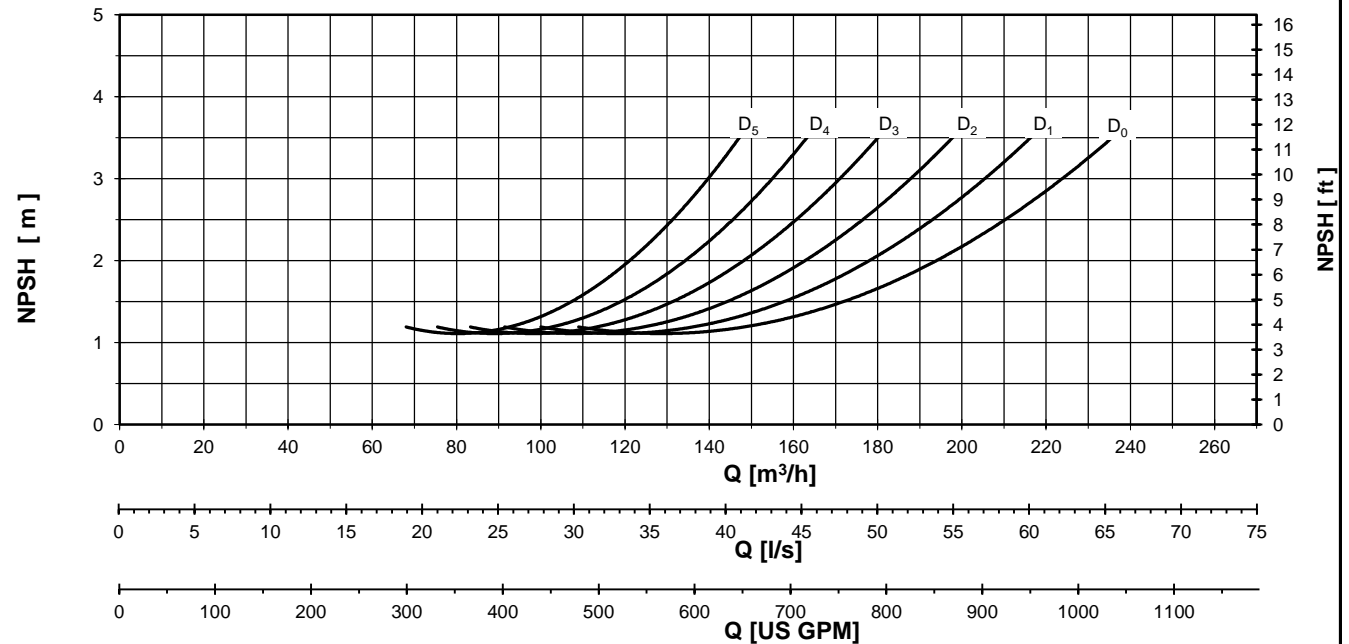
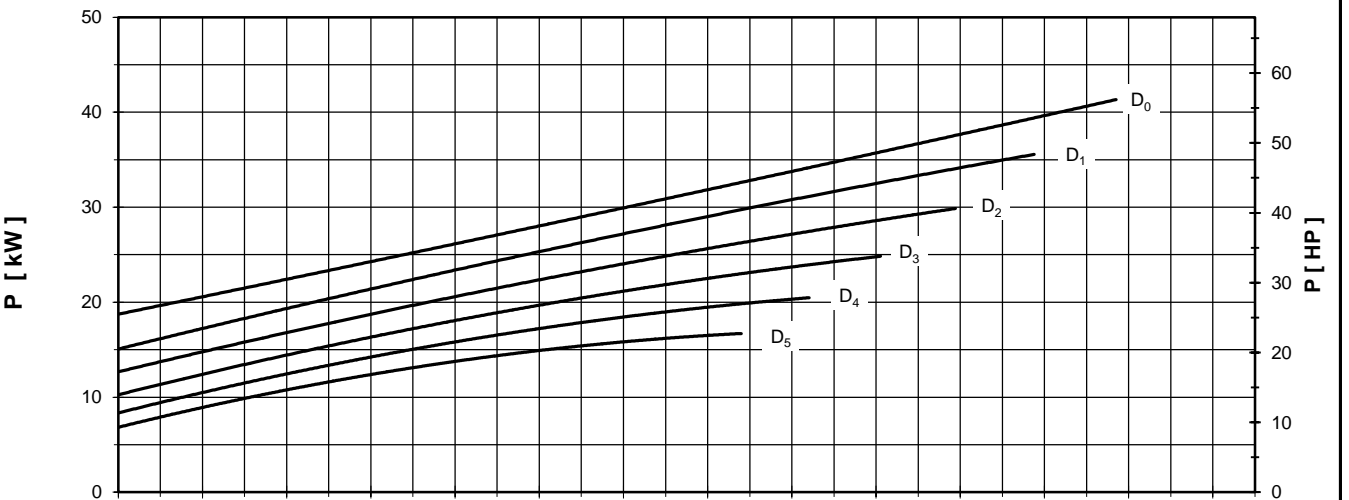
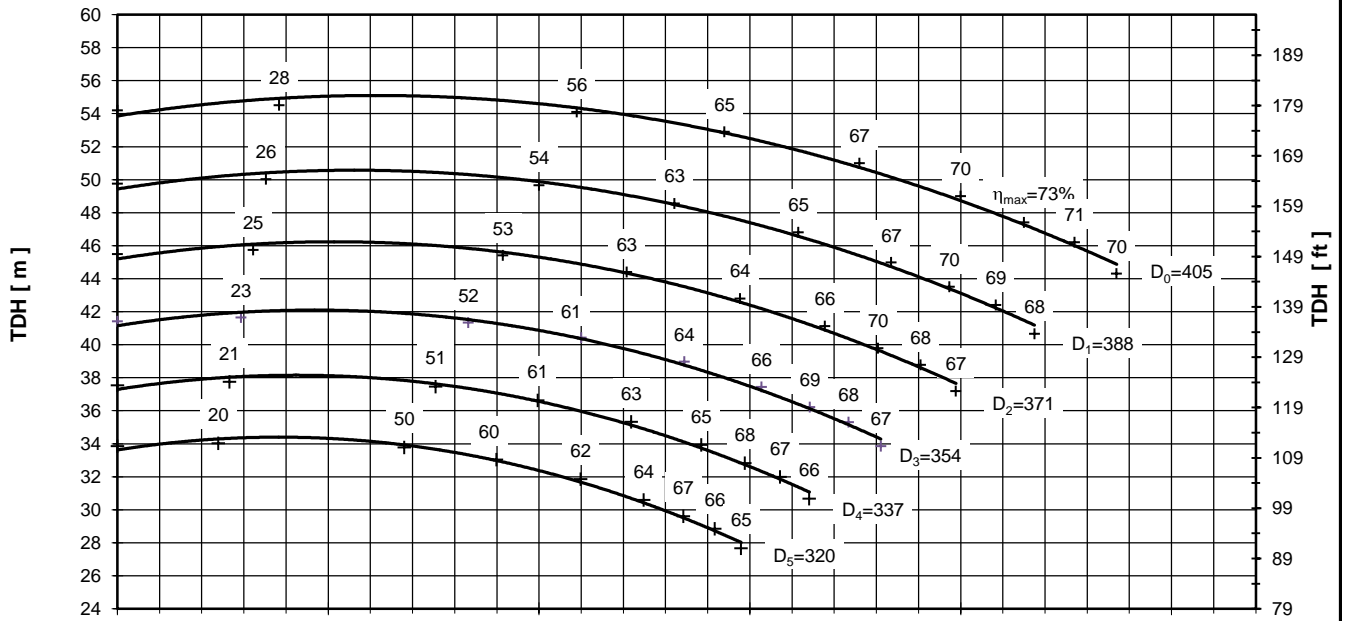

Performance curves are valid for clean cold water-kinematic viscosity 1 [mm²/s], density 1000 [kg/m³]. Methods and tolerances of presented performance curves are in accordance with ISO 9906 - Annex A



PUMP PERFORMANCE CURVES
No. 4HD.0172.03

PUMP TYPE
SCP 150 - 250
1450 [rpm]

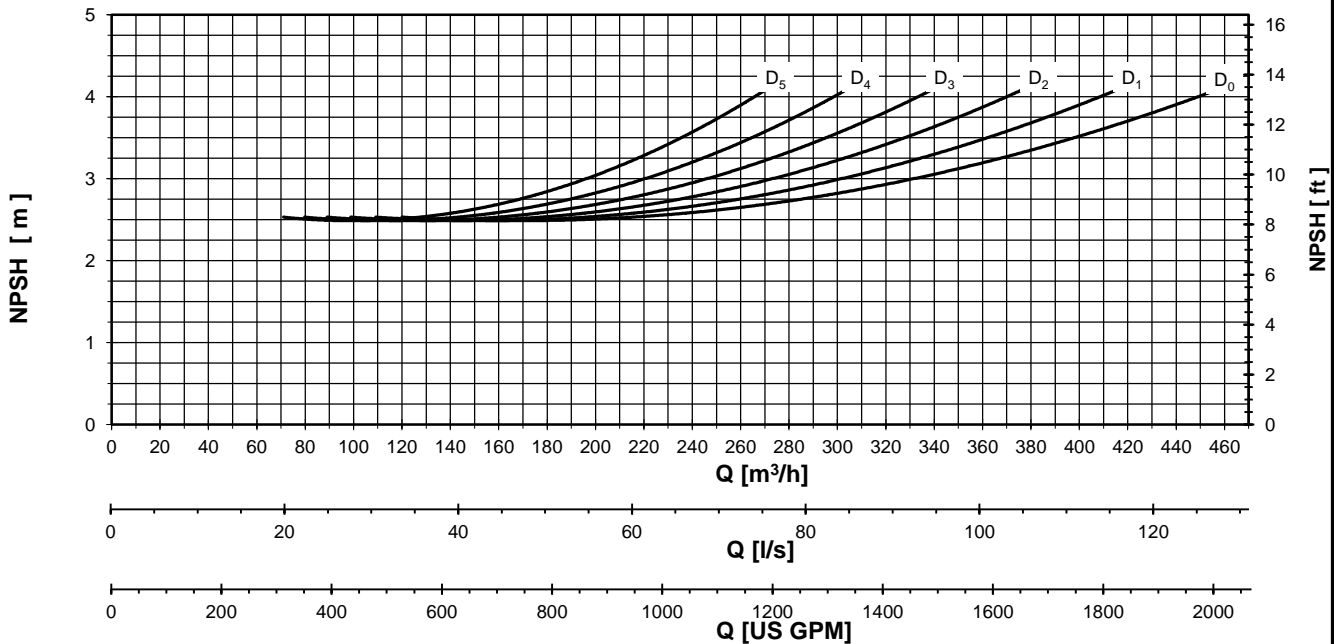
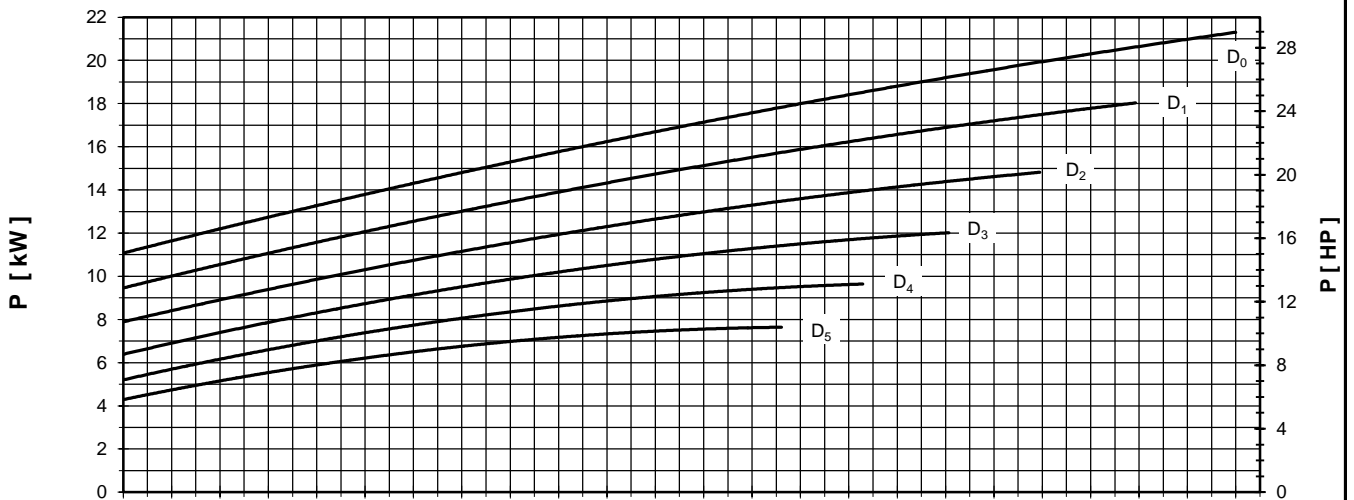
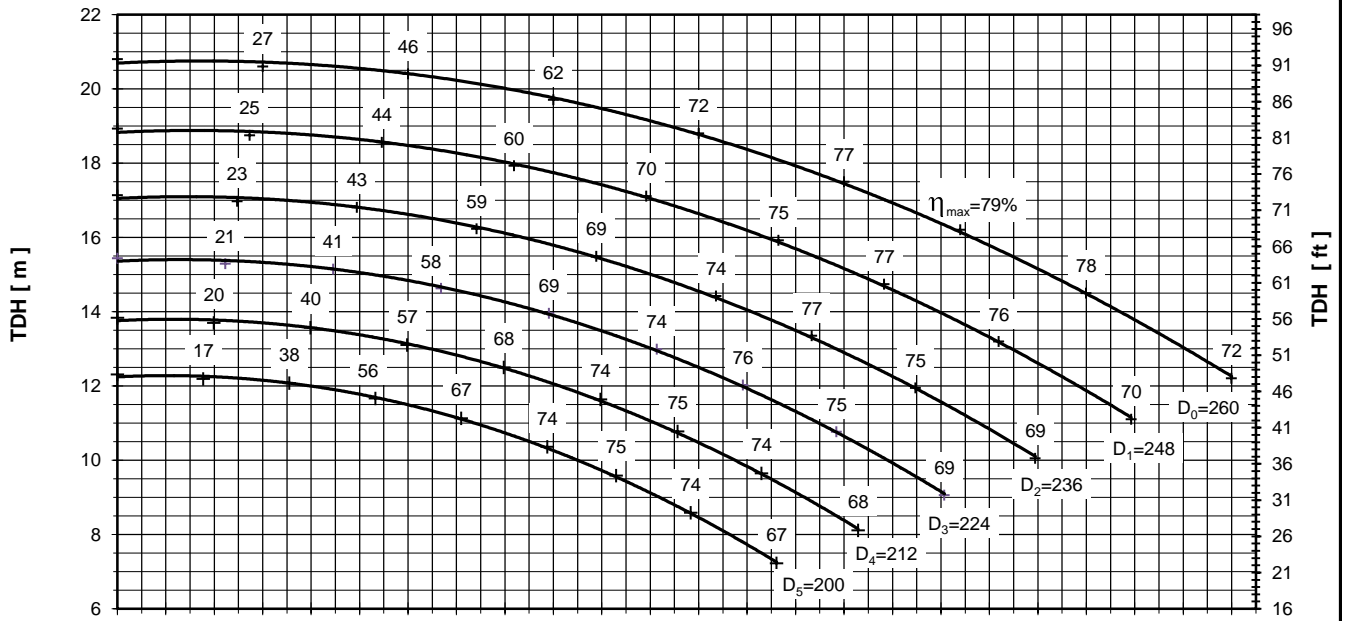

Performance curves are valid for clean cold water-kinematic viscosity 1 [mm²/s], density 1000 [kg/m³]. Methods and tolerances of presented performance curves are in accordance with ISO 9906 - Annex A

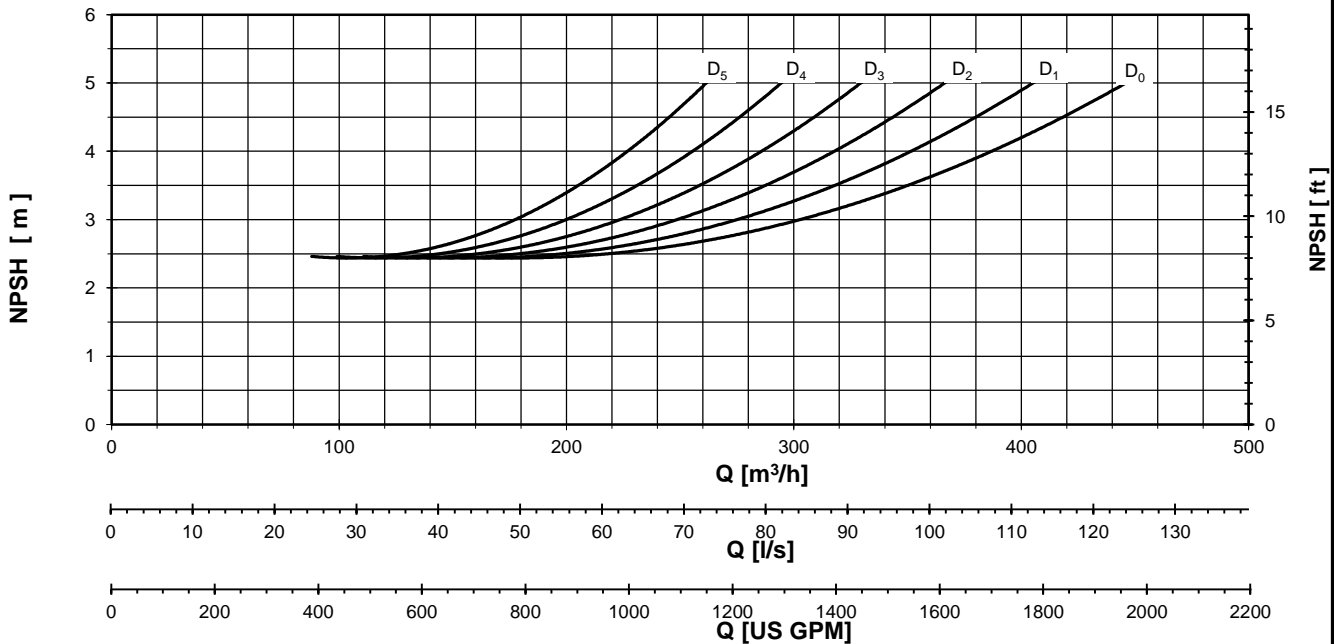
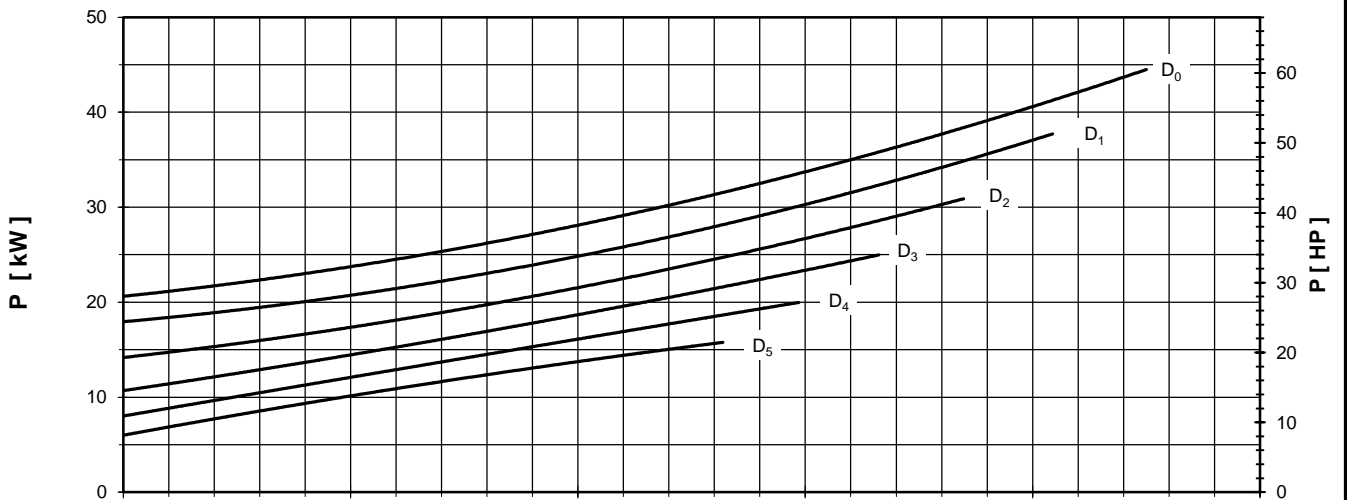
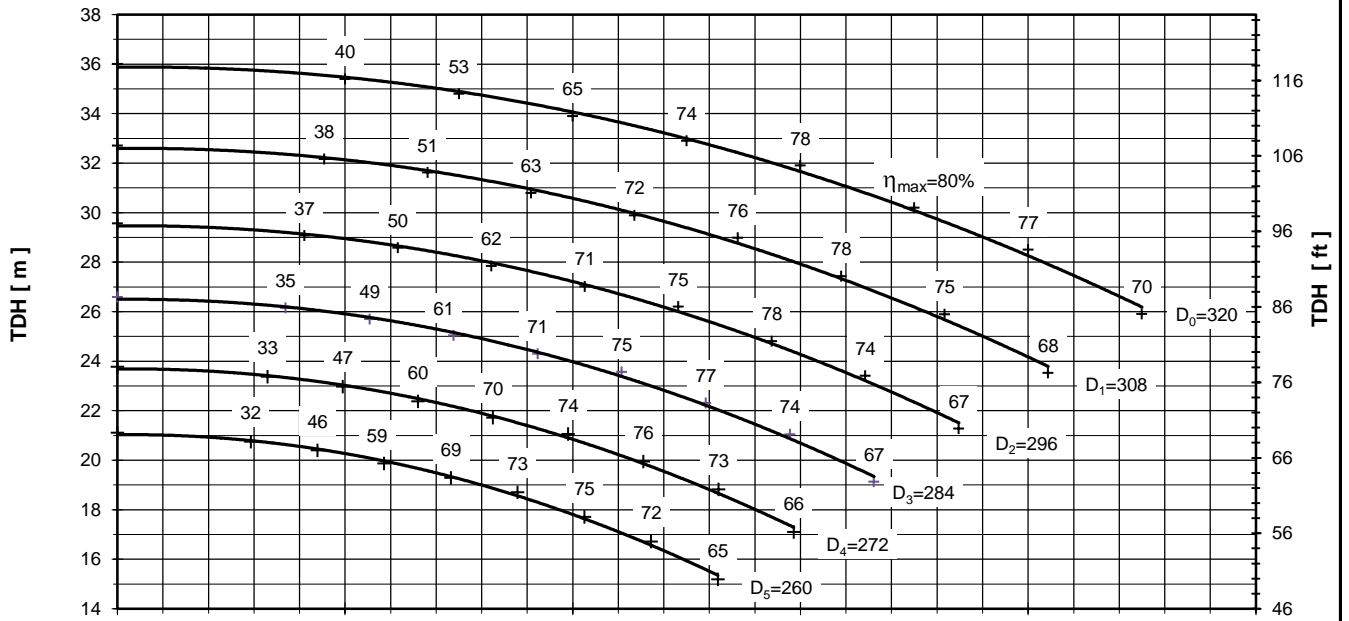

Performance curves are valid for clean cold water-kinematic viscosity 1 [mm²/s], density 1000 [kg/m³]. Methods and tolerances of presented performance curves are in accordance with ISO 9906 - Annex A

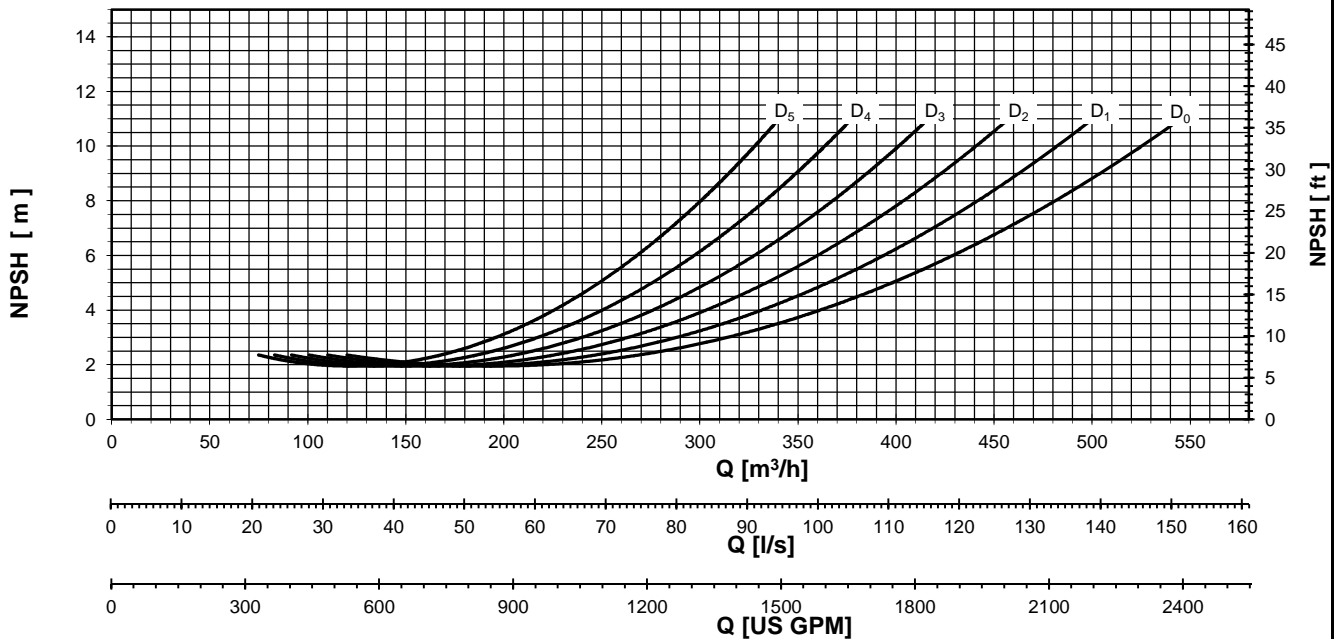
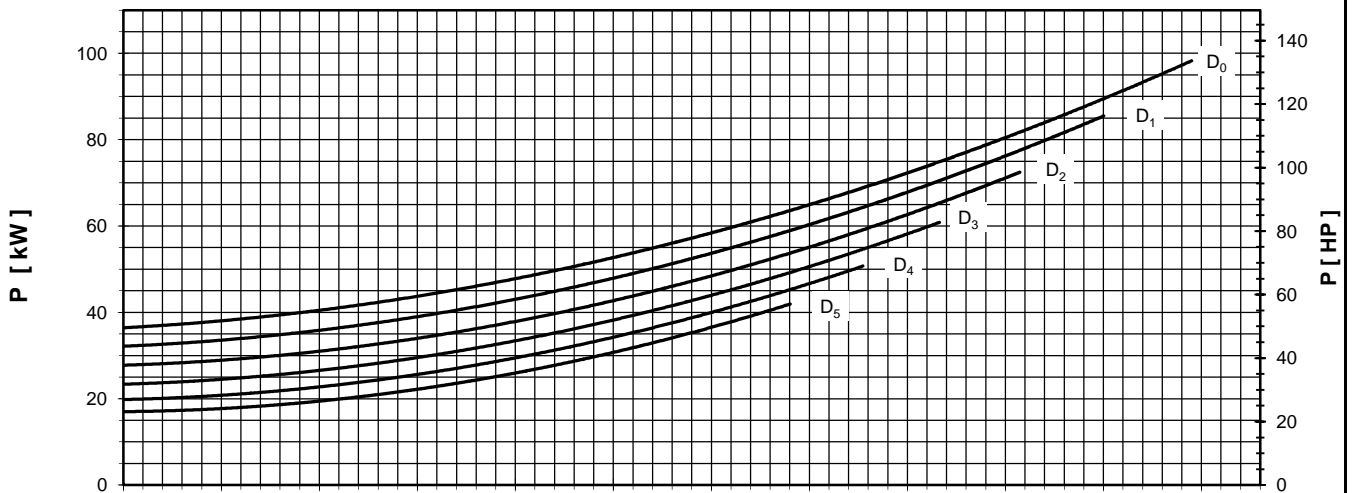
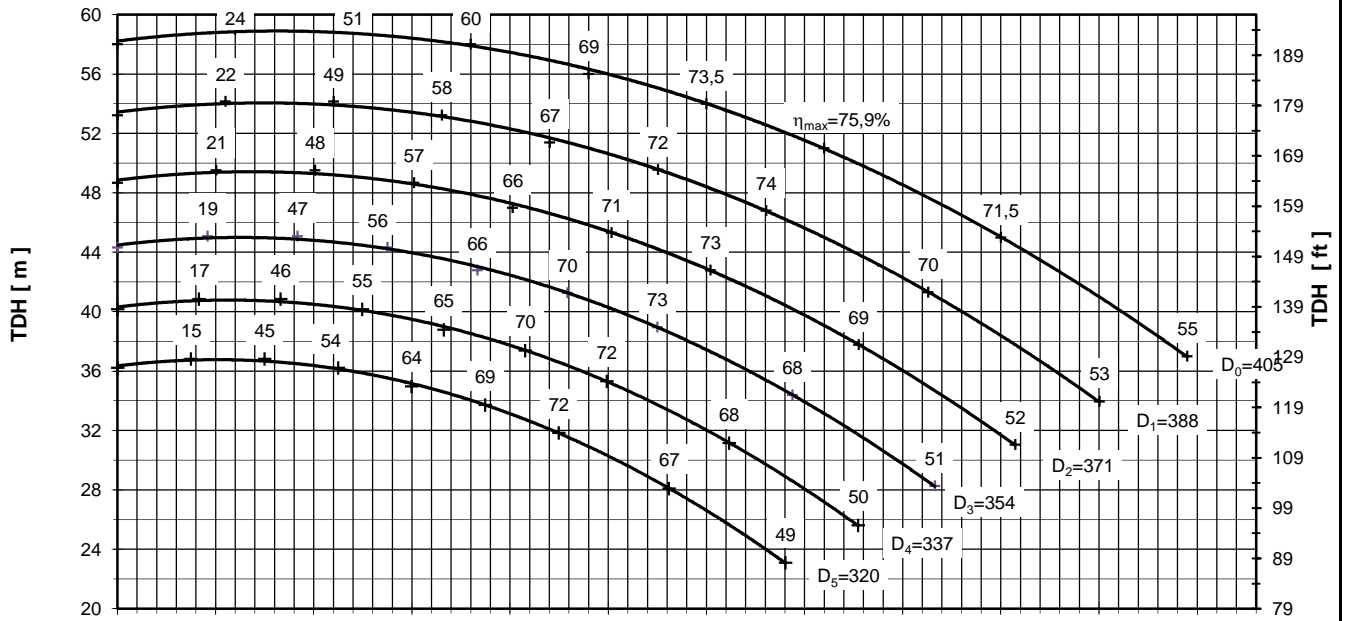

Performance curves are valid for clean cold water-kinematic viscosity 1 [mm²/s], density 1000 [kg/m³]. Methods and tolerances of presented performance curves are in accordance with ISO 9906 - Annex A

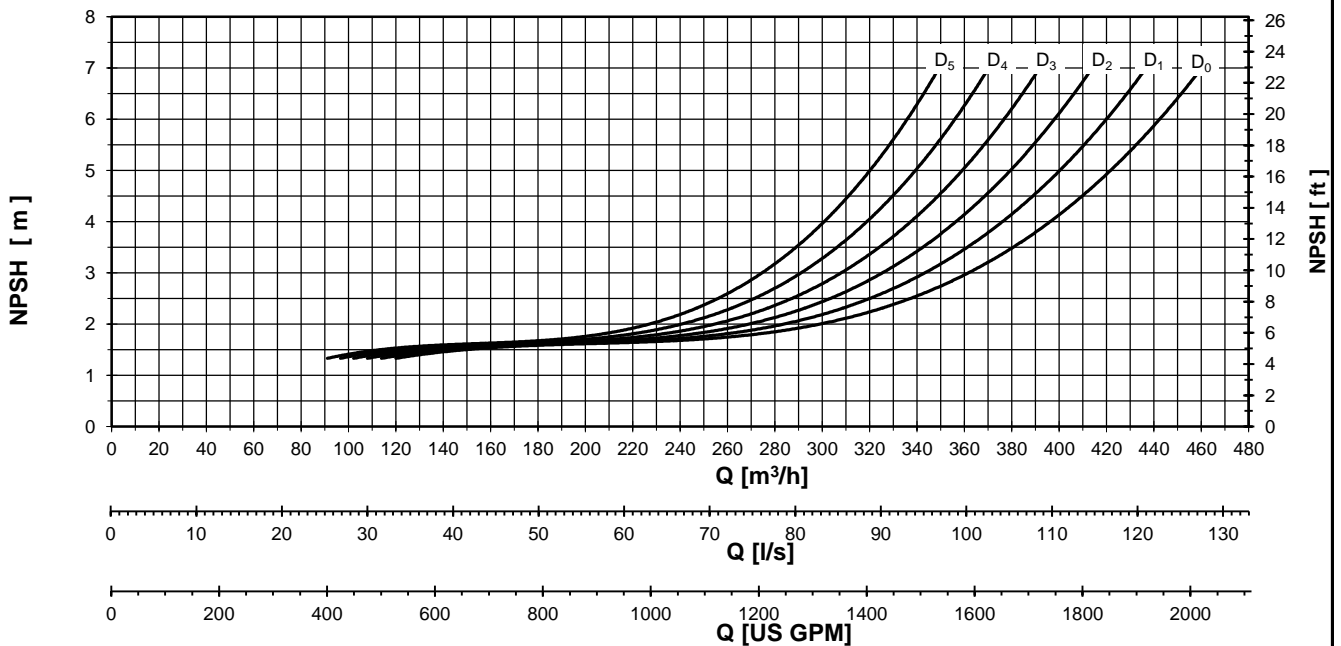
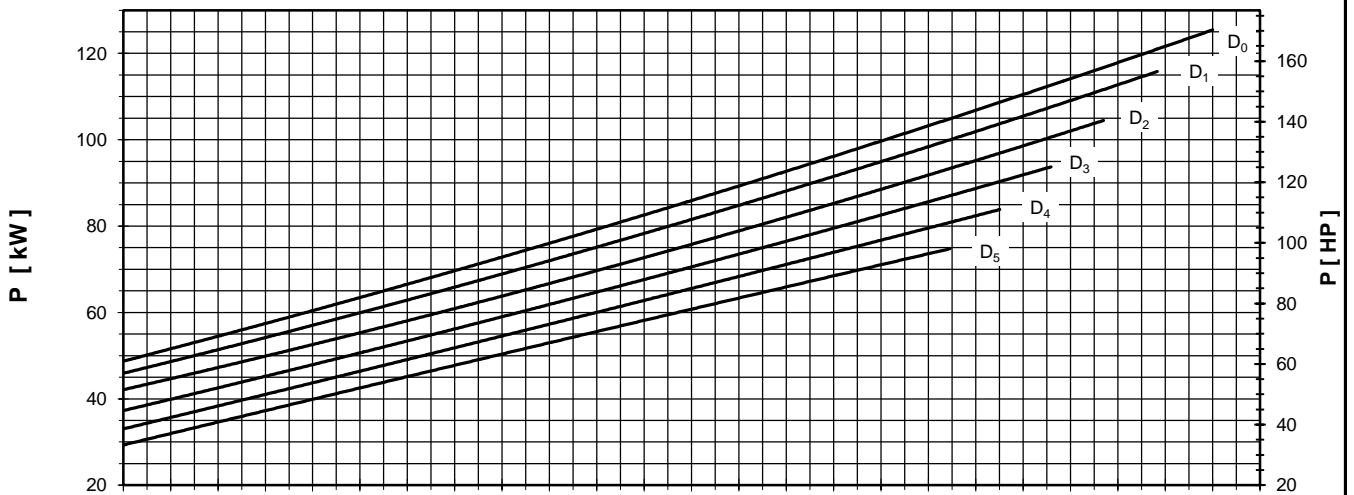
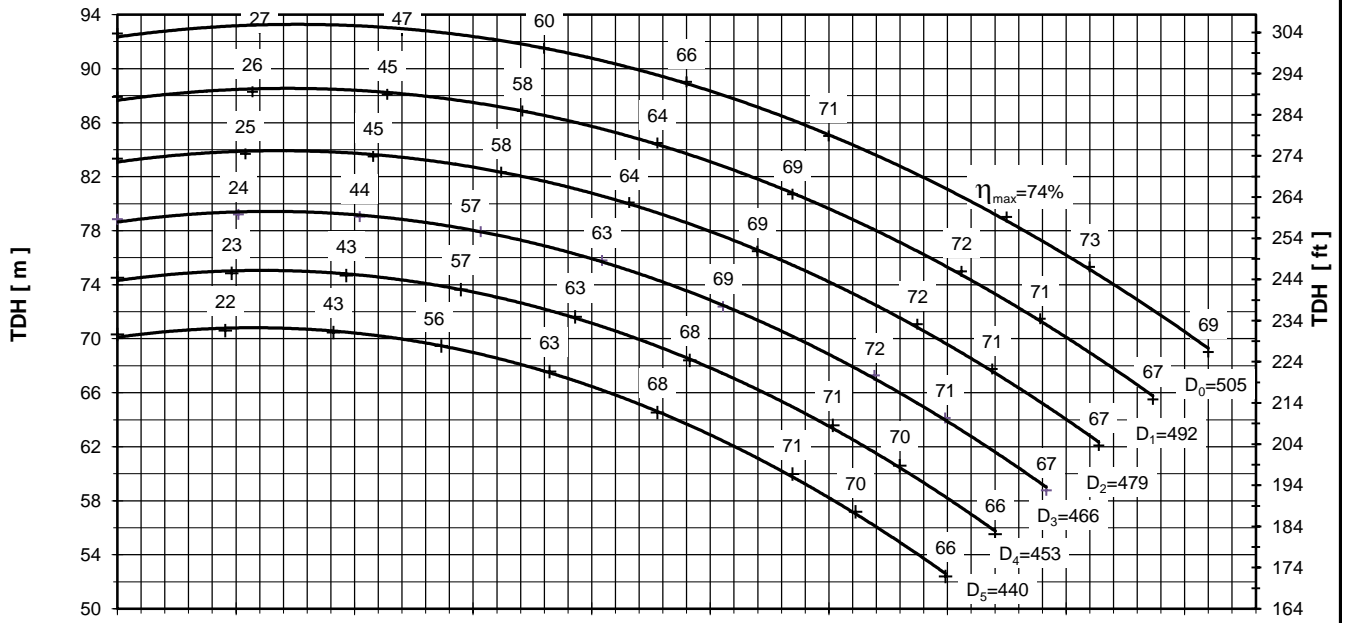

Performance curves are valid for clean cold water-kinematic viscosity 1 [mm²/s], density 1000 [kg/m³]. Methods and tolerances of presented performance curves are in accordance with ISO 9906 - Annex A

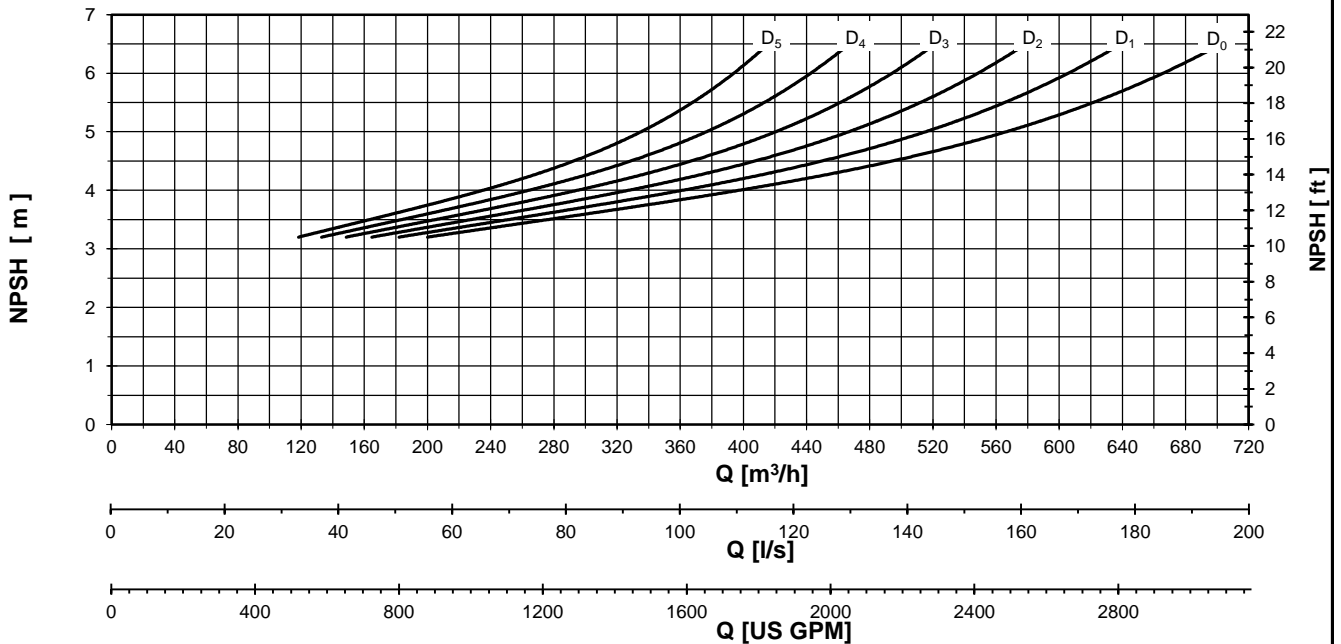
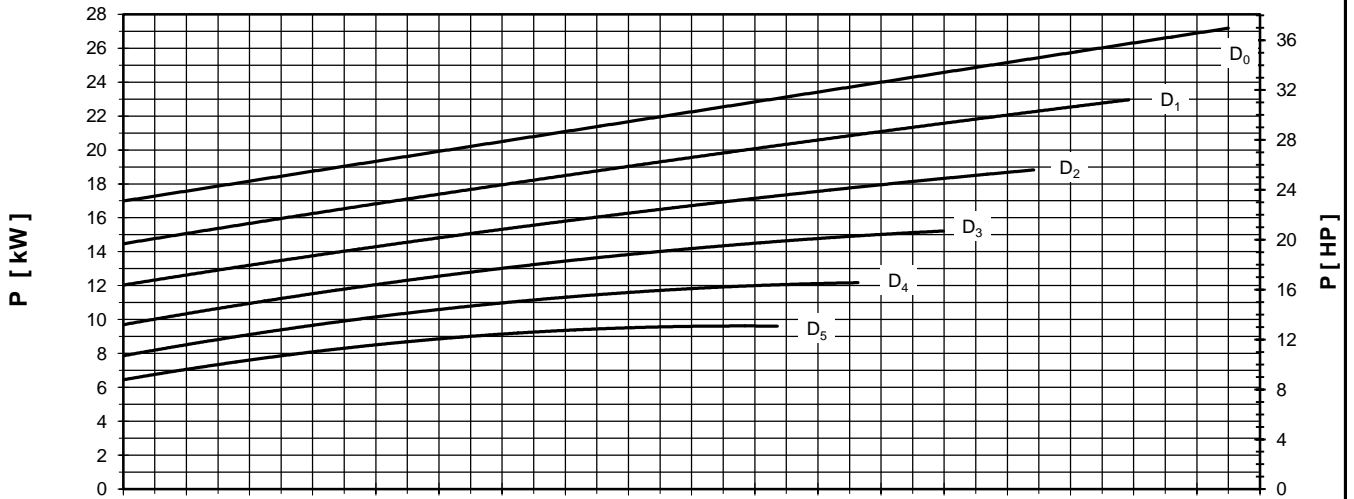
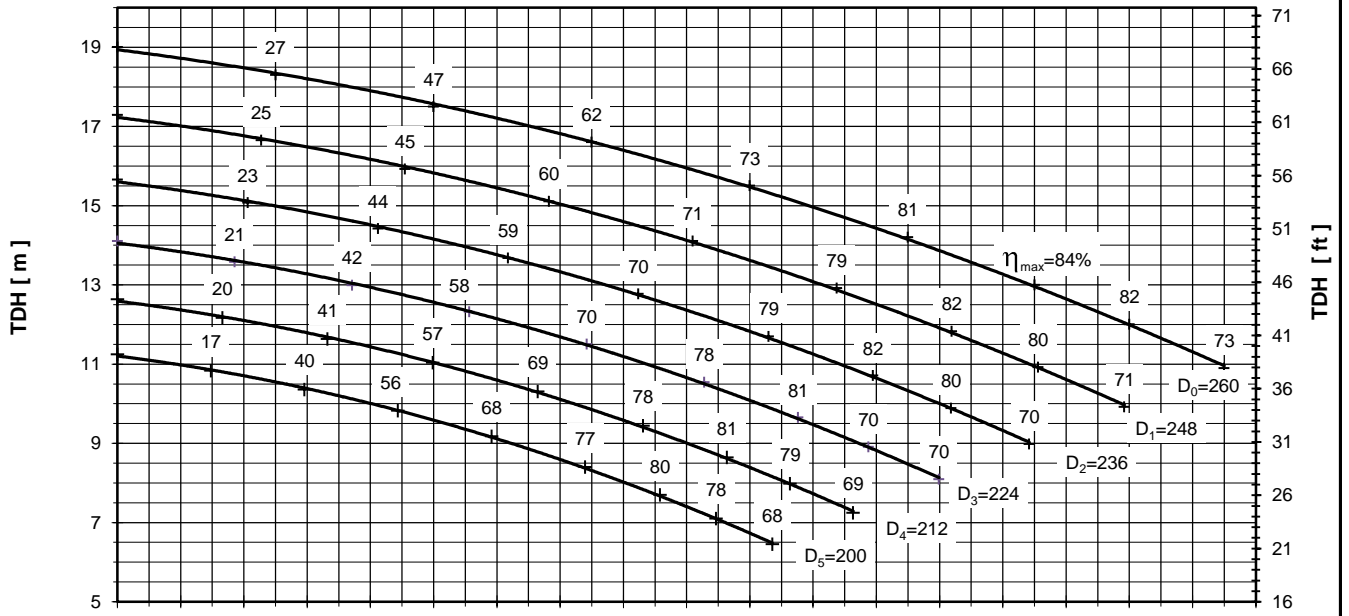

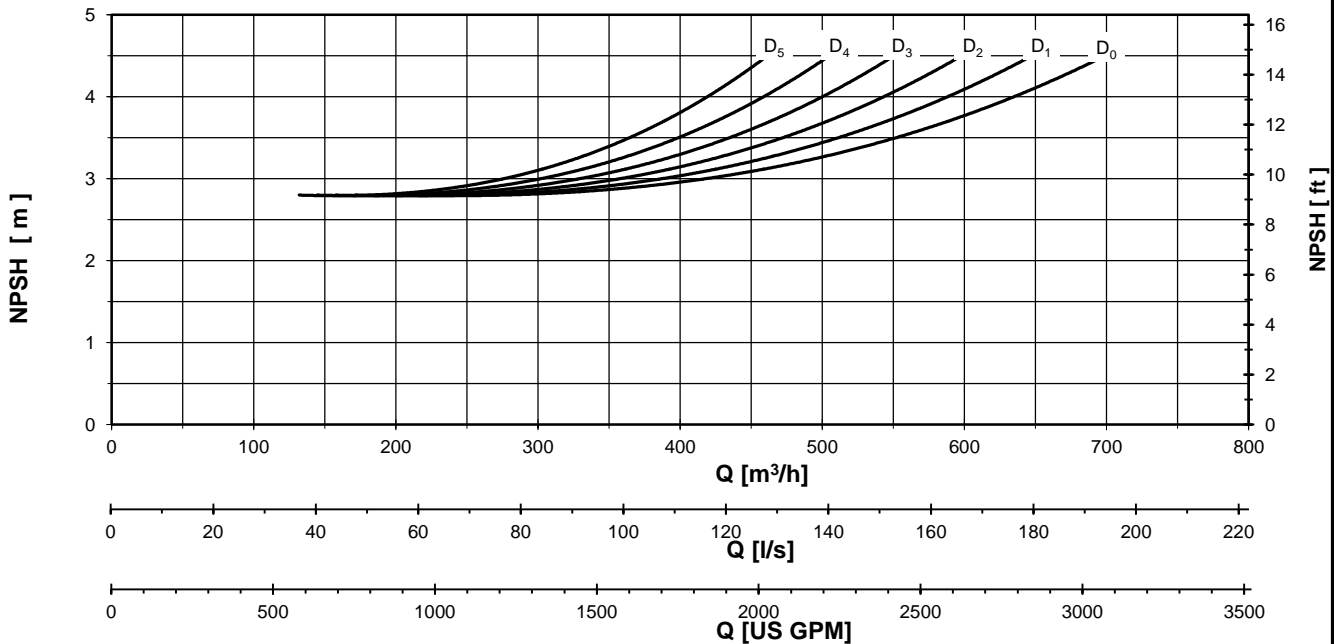
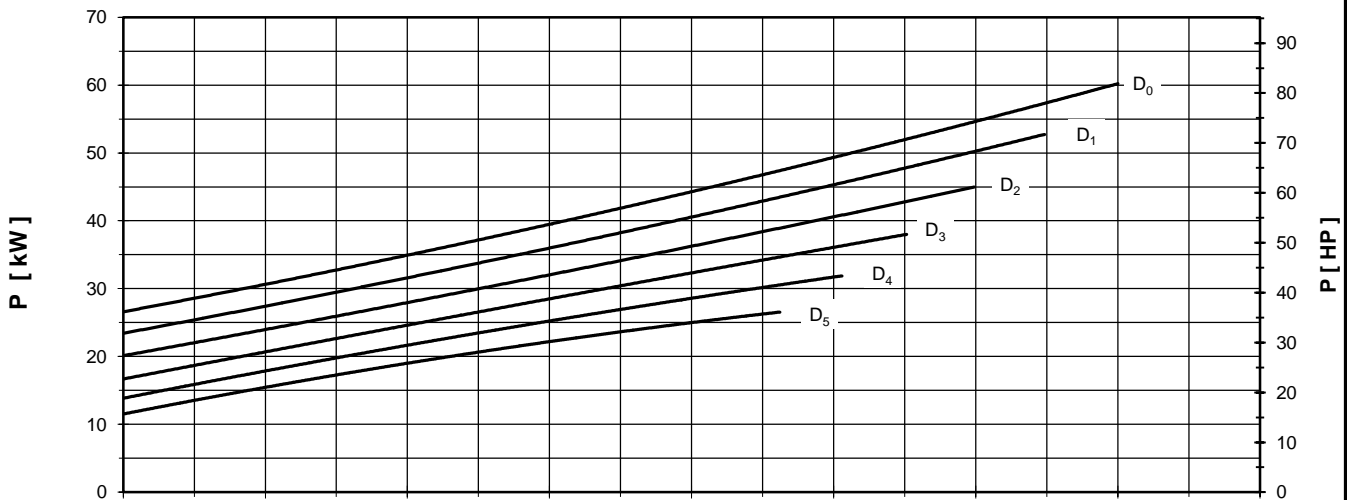
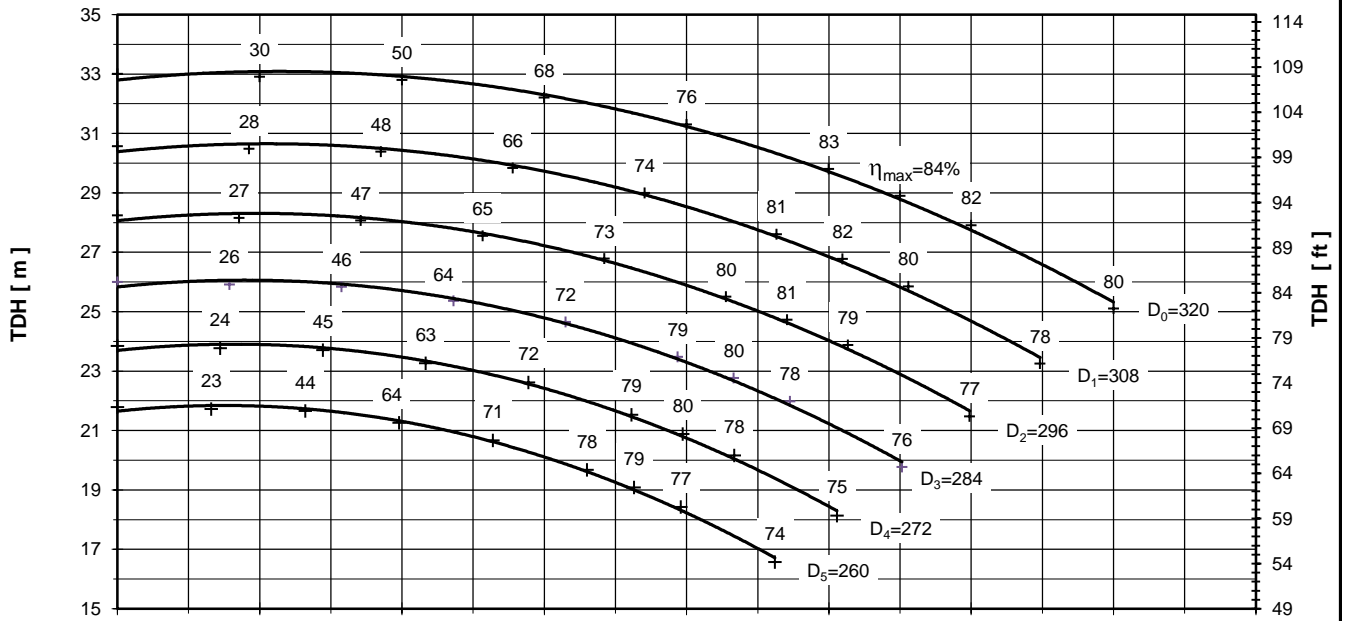

Performance curves are valid for clean cold water-kinematic viscosity 1 [mm²/s], density 1000 [kg/m³]. Methods and tolerances of presented performance curves are in accordance with ISO 9906 - Annex A



PUMP PERFORMANCE CURVES
No. 4HD.0177.03

PUMP TYPE
SCP 200 - 400
1450 [rpm]

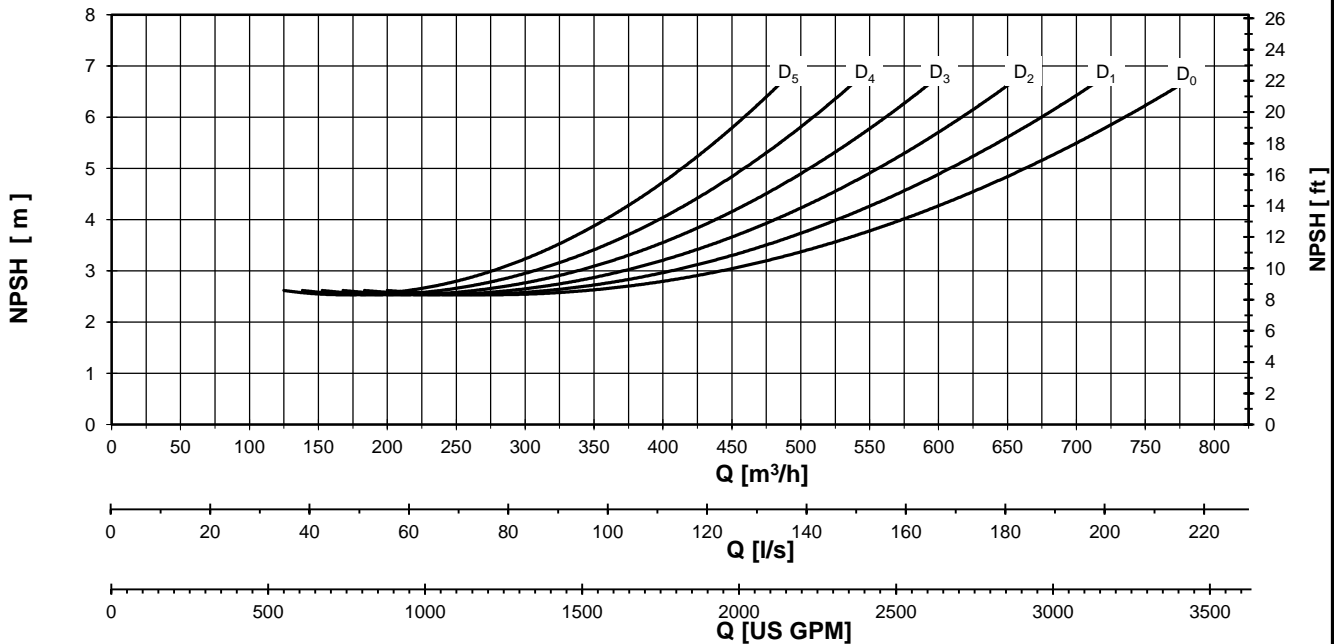
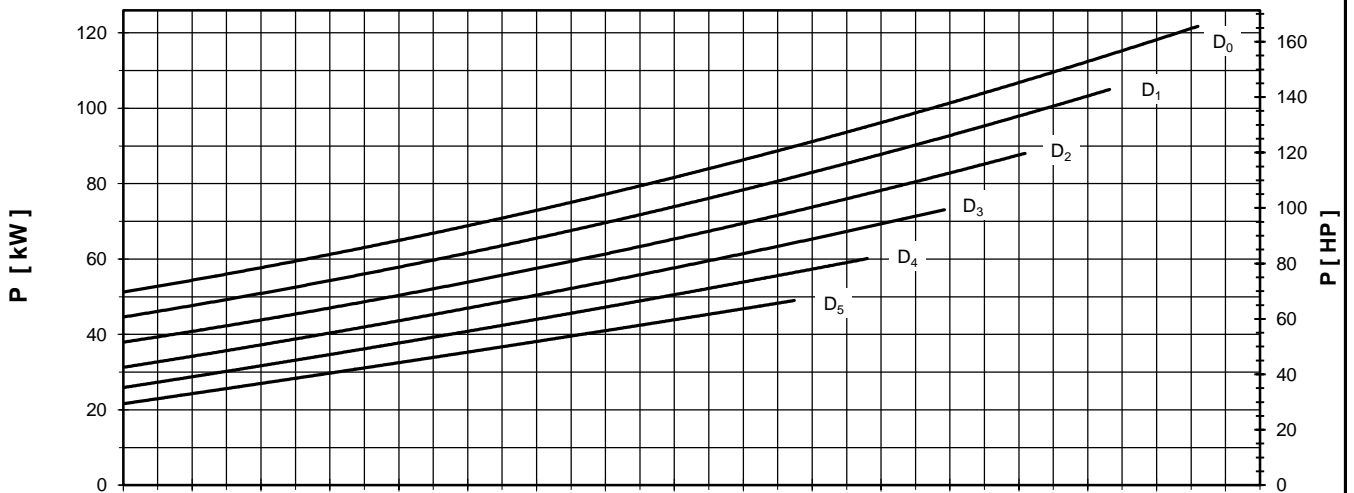
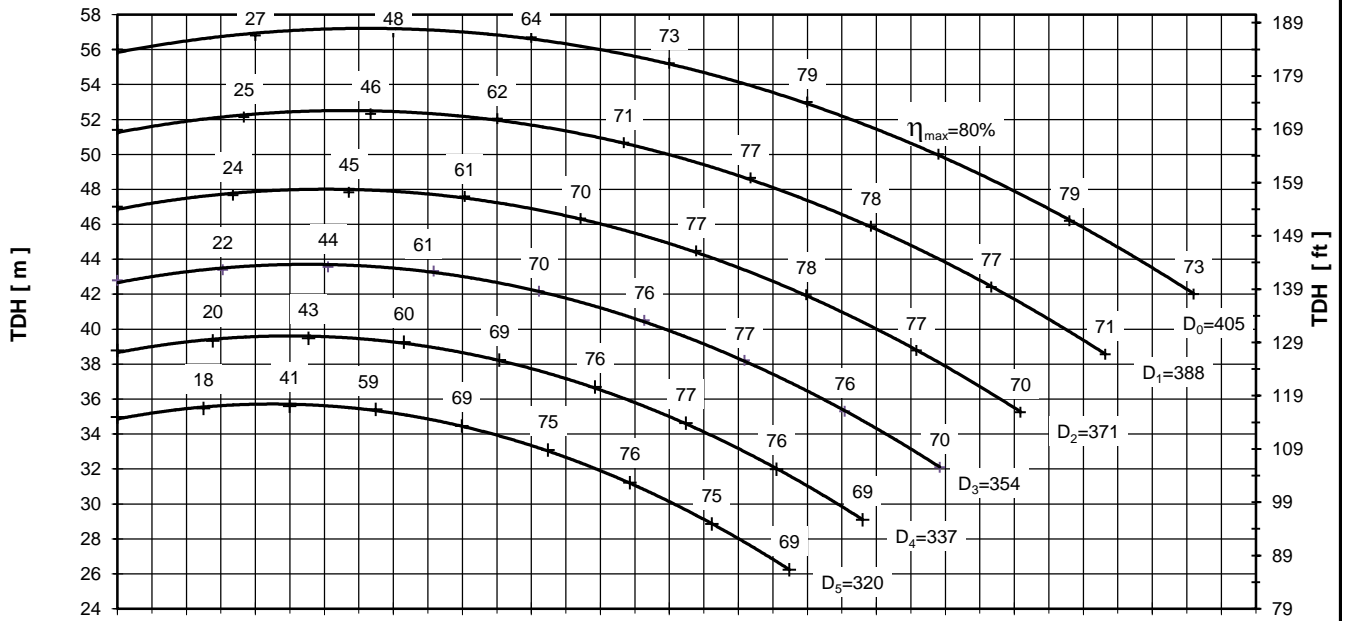

Performance curves are valid for clean cold water-kinematic viscosity 1 [mm²/s], density 1000 [kg/m³]. Methods and tolerances of presented performance curves are in accordance with ISO 9906 - Annex A



PUMP PERFORMANCE CURVES
No. 4HD.0178.03

PUMP TYPE
SCP 200 - 500
1450 [rpm]

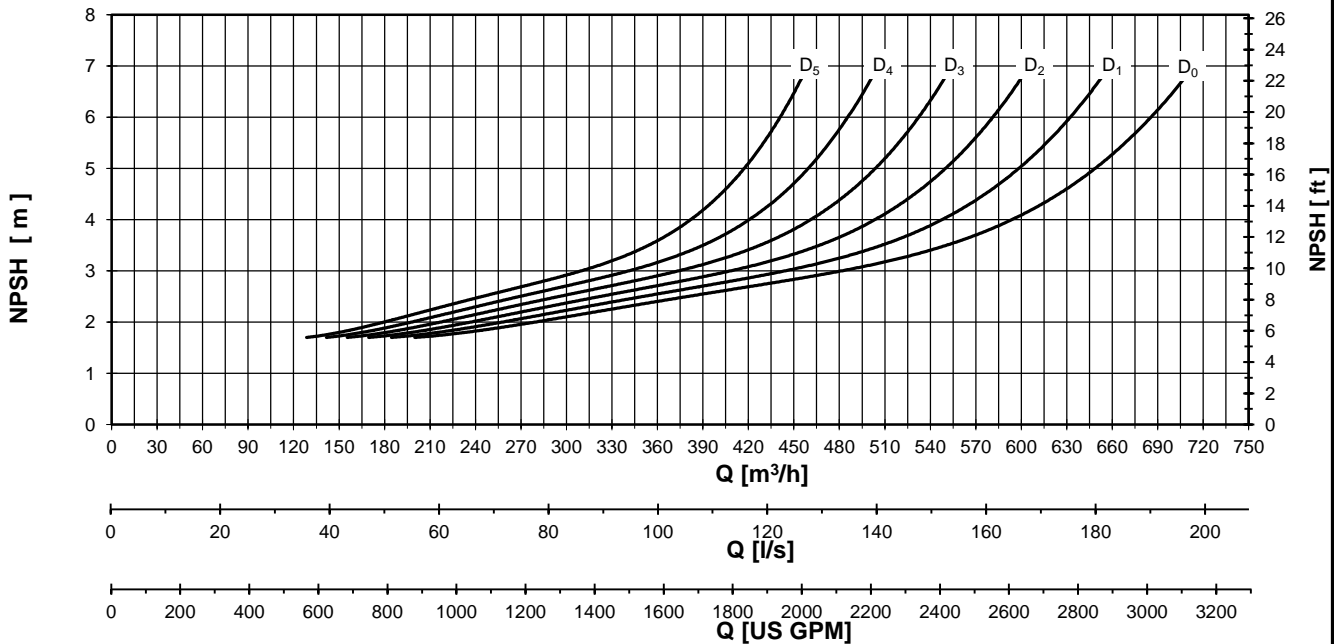
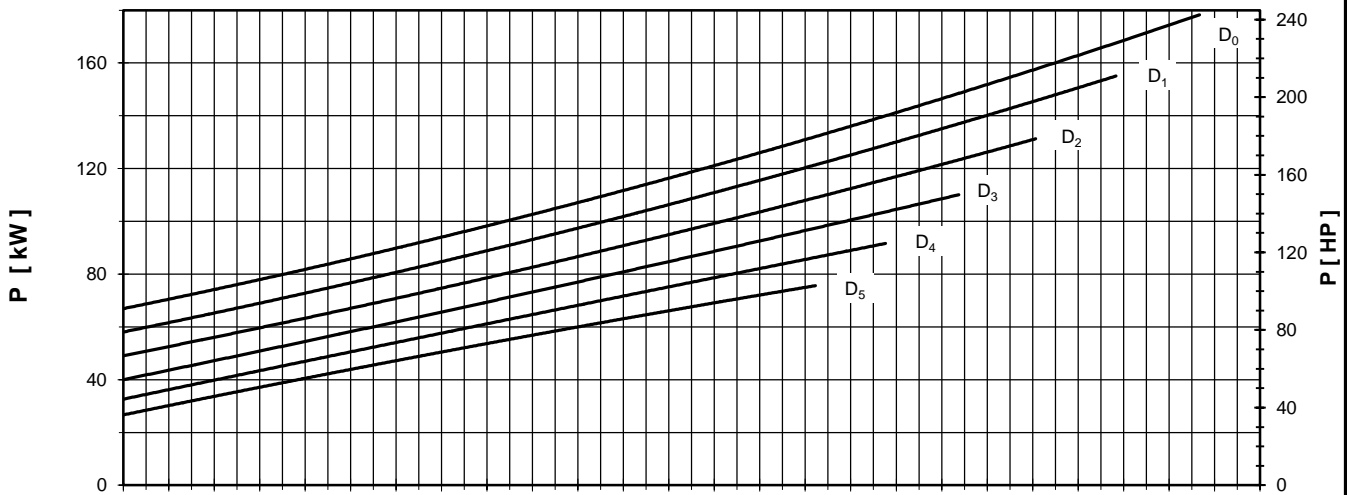
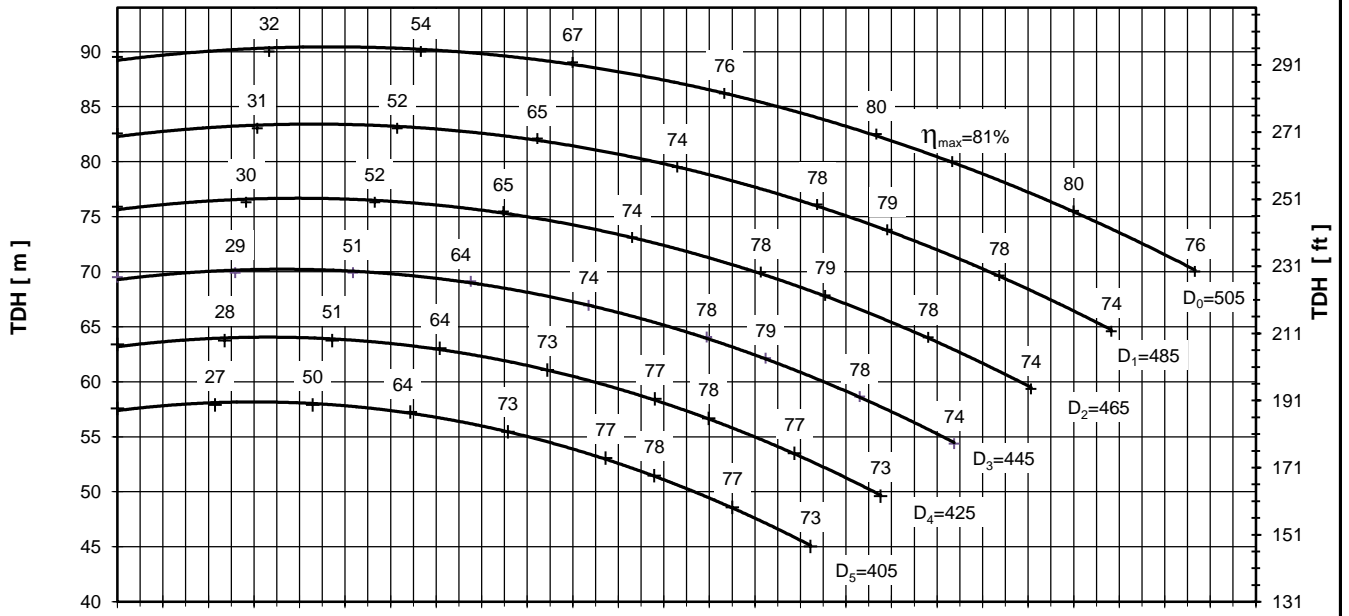

Performance curves are valid for clean cold water-kinematic viscosity 1 [mm²/s], density 1000 [kg/m³]. Methods and tolerances of presented performance curves are in accordance with ISO 9906 - Annex A

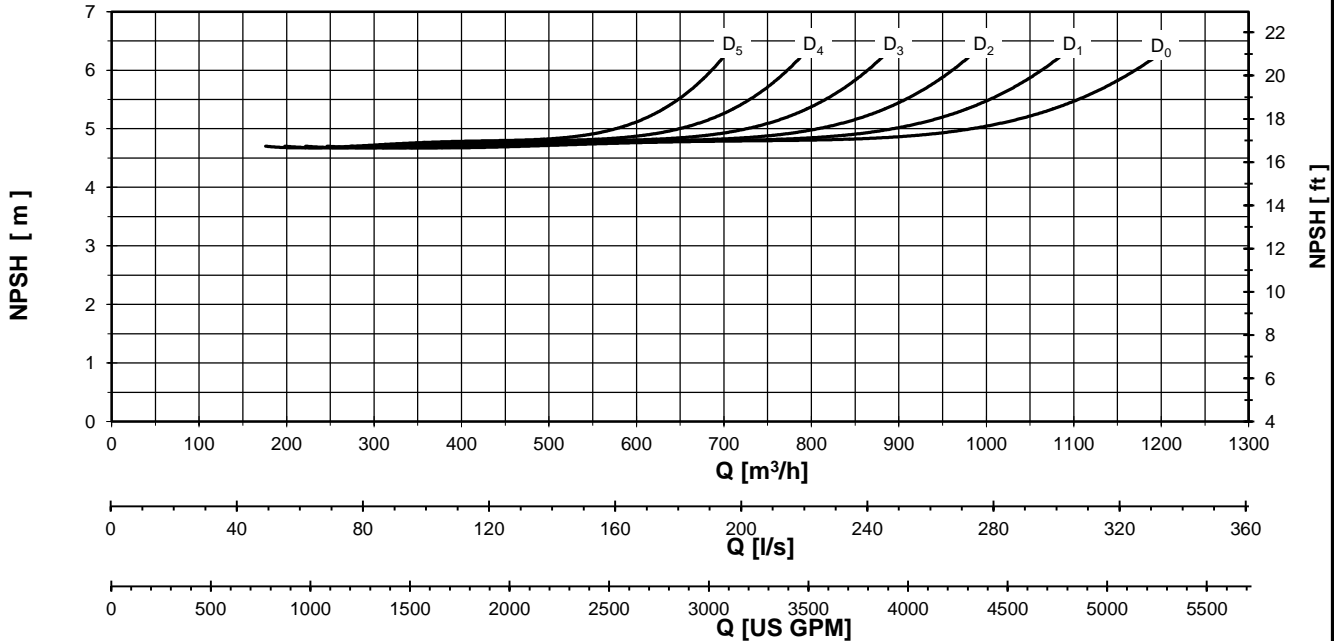
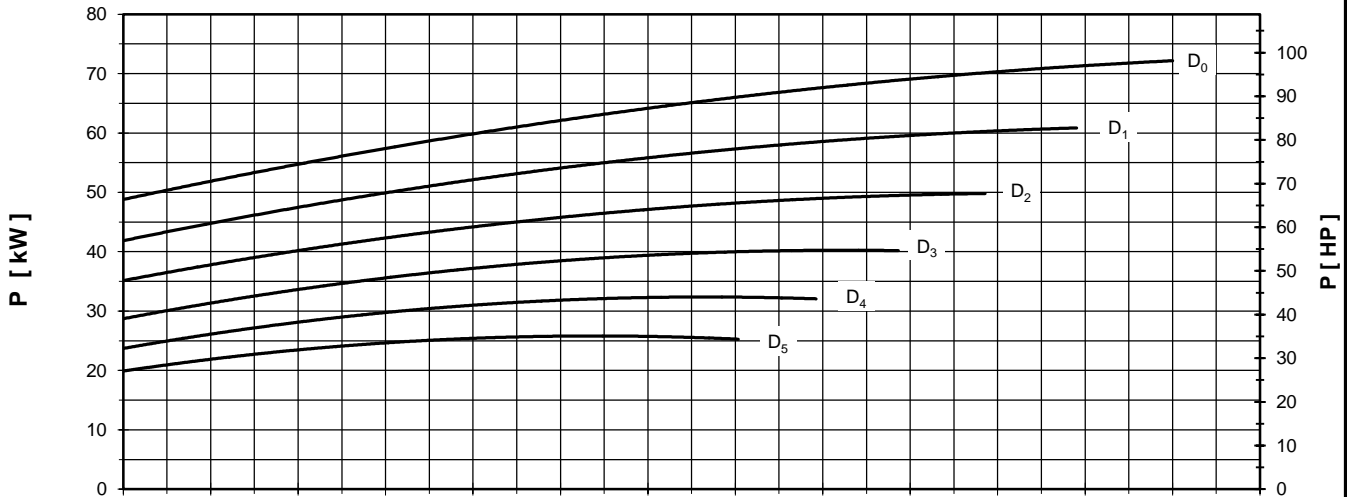
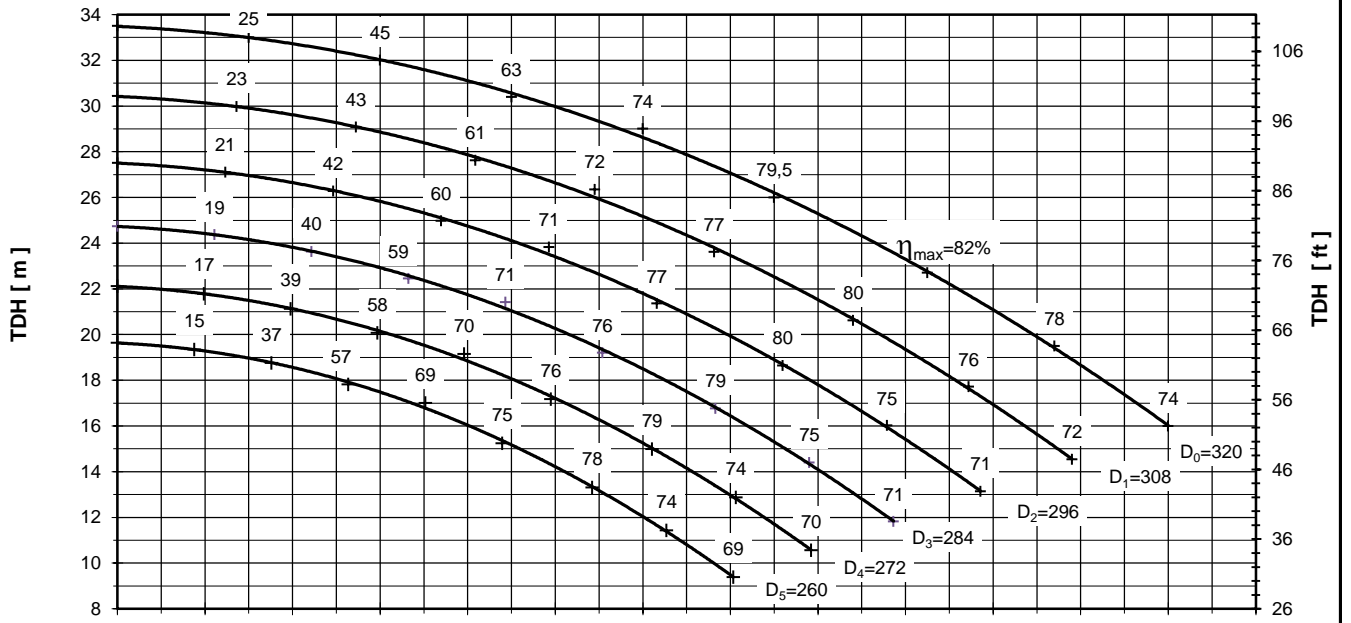



PUMP PERFORMANCE CURVES
No. 4HD.0179.03

PUMP TYPE
SCP 250 - 400
1450 [rpm]

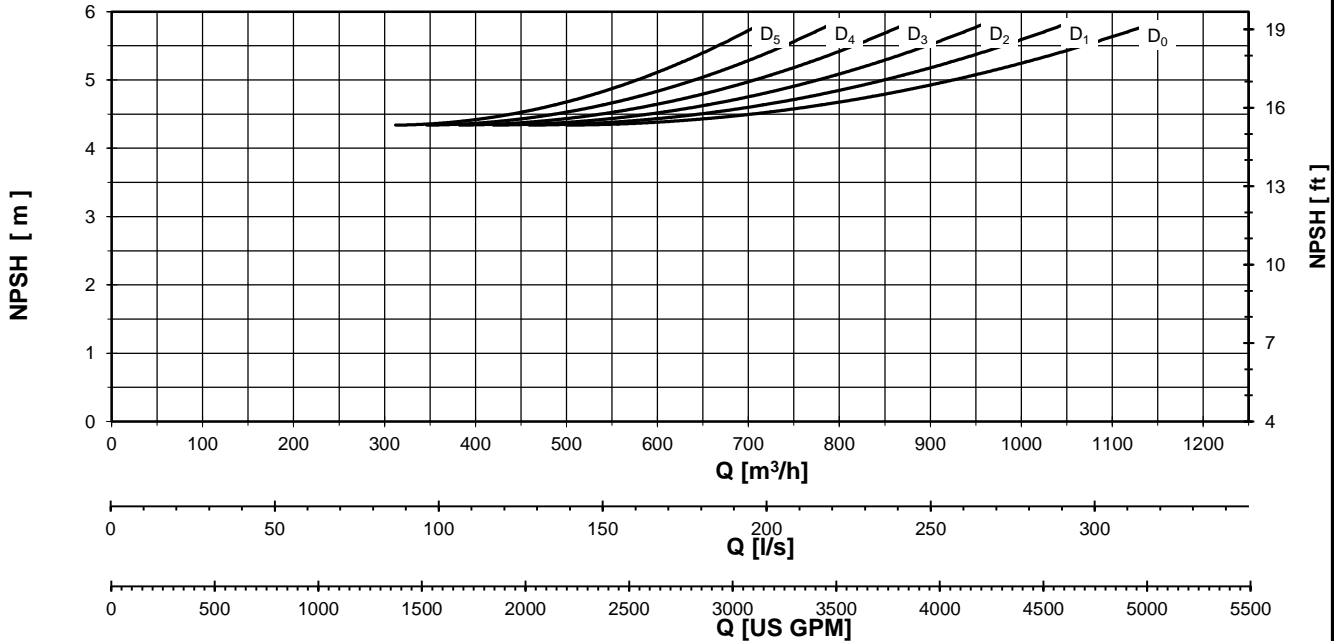
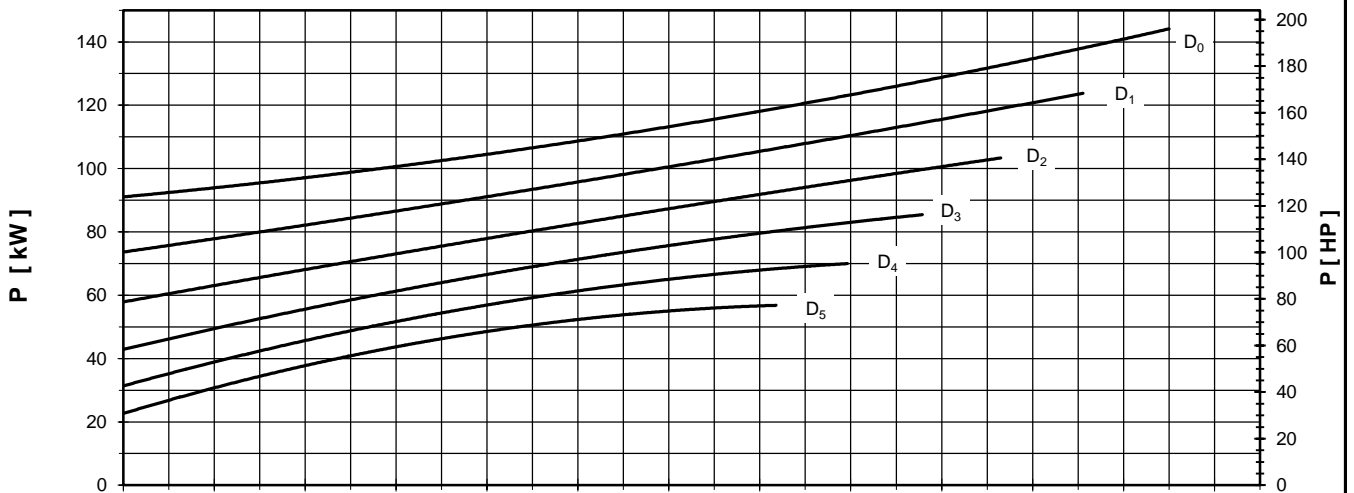
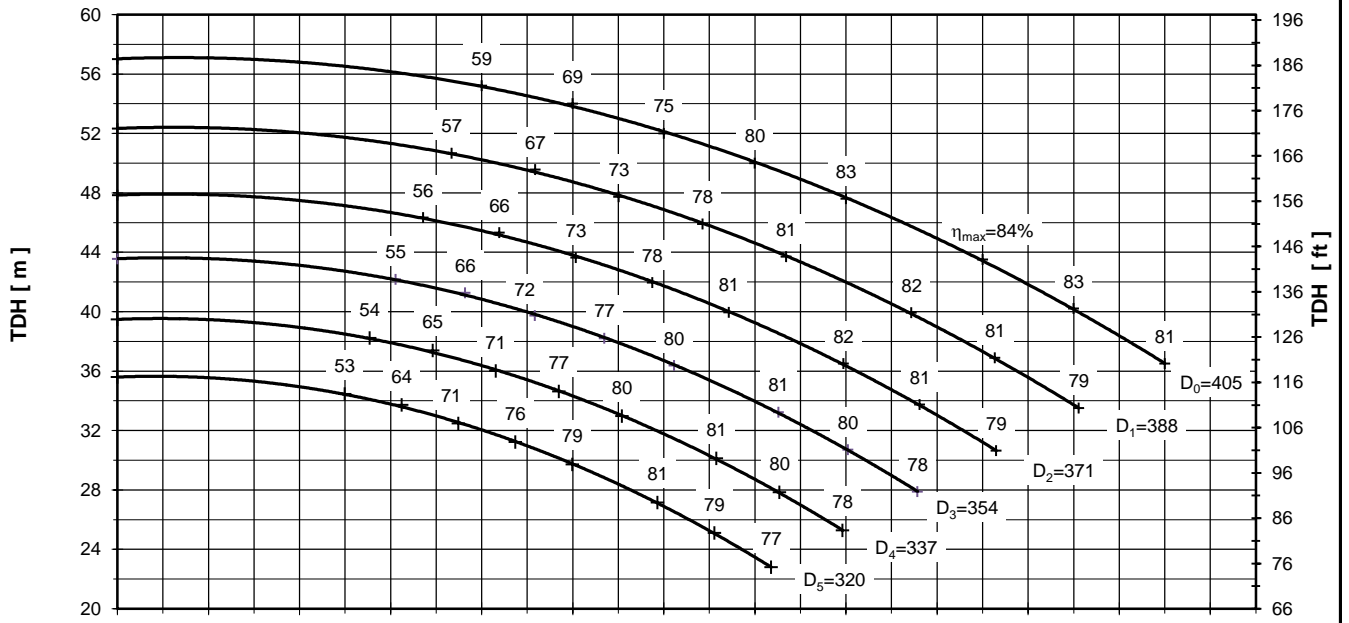

Performance curves are valid for clean cold water-kinematic viscosity 1 [mm²/s], density 1000 [kg/m³]. Methods and tolerances of presented performance curves are in accordance with ISO 9906 - Annex A



PUMP PERFORMANCE CURVES
No. 4HD.0180.03

PUMP TYPE
SCP 250 - 500
1450 [rpm]

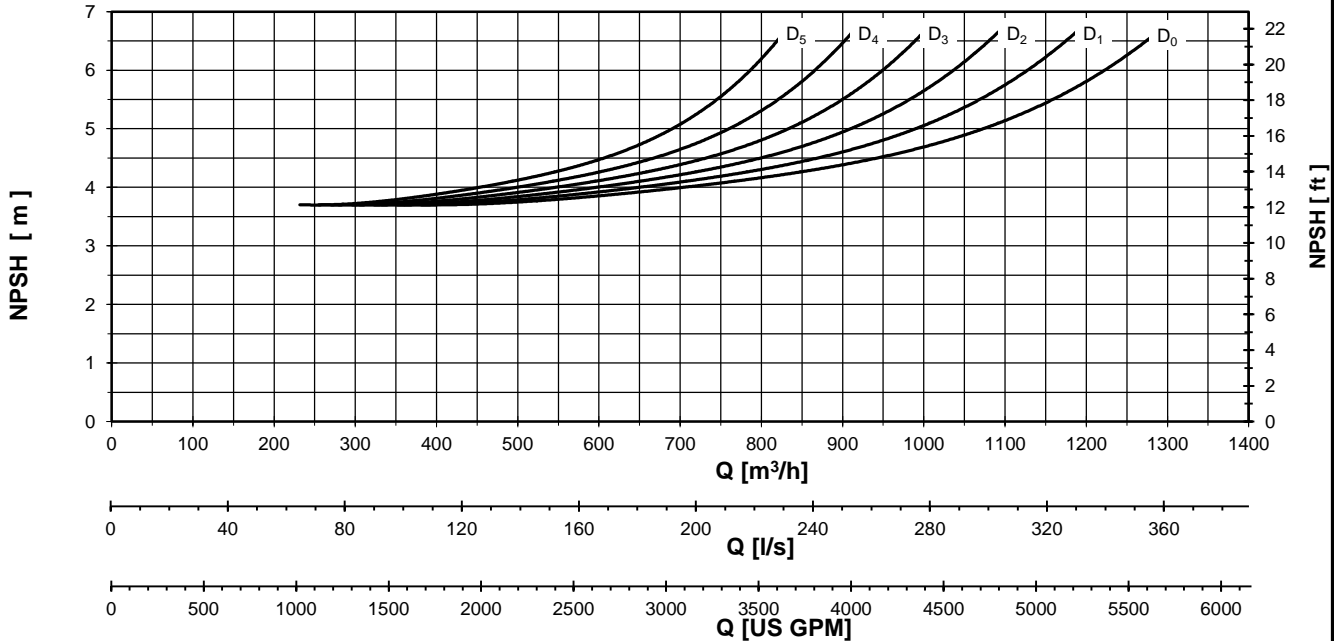
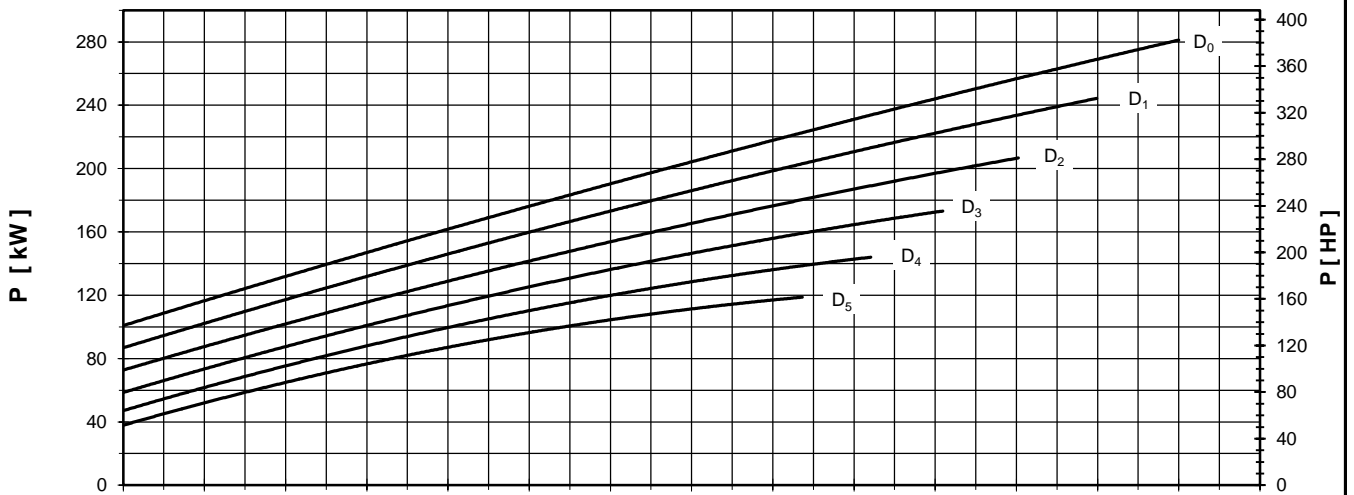
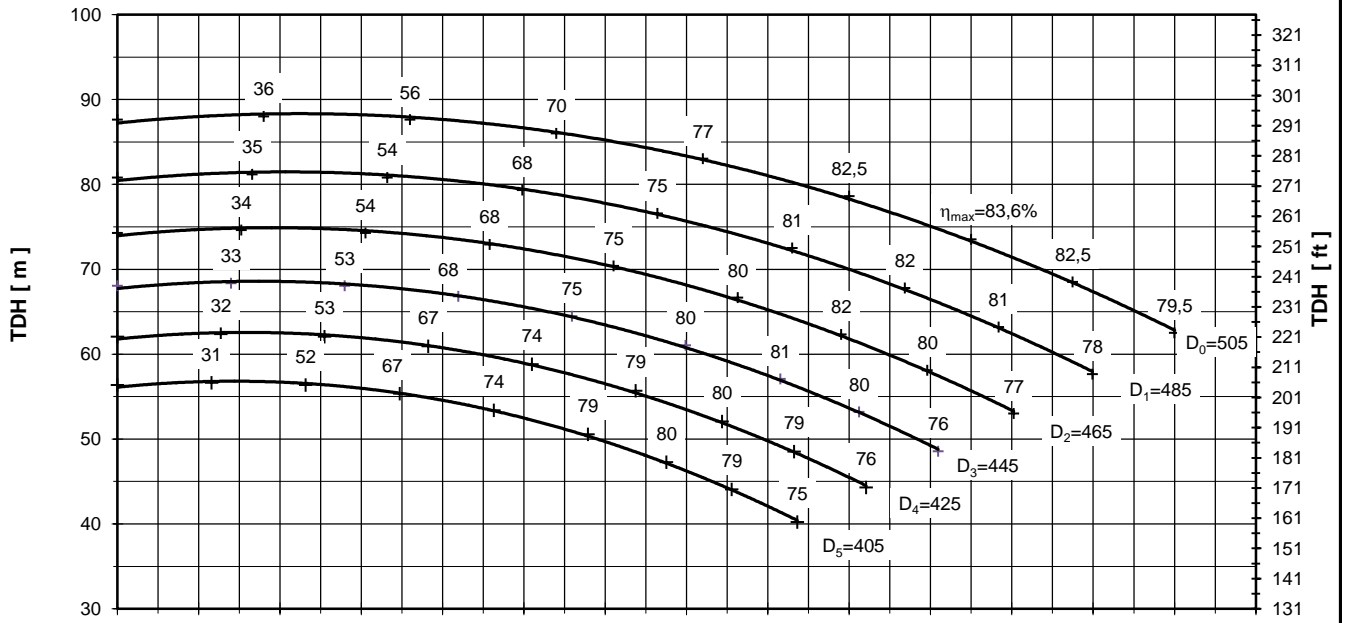

Performance curves are valid for clean cold water-kinematic viscosity 1 [mm²/s], density 1000 [kg/m³]. Methods and tolerances of presented performance curves are in accordance with ISO 9906 - Annex A

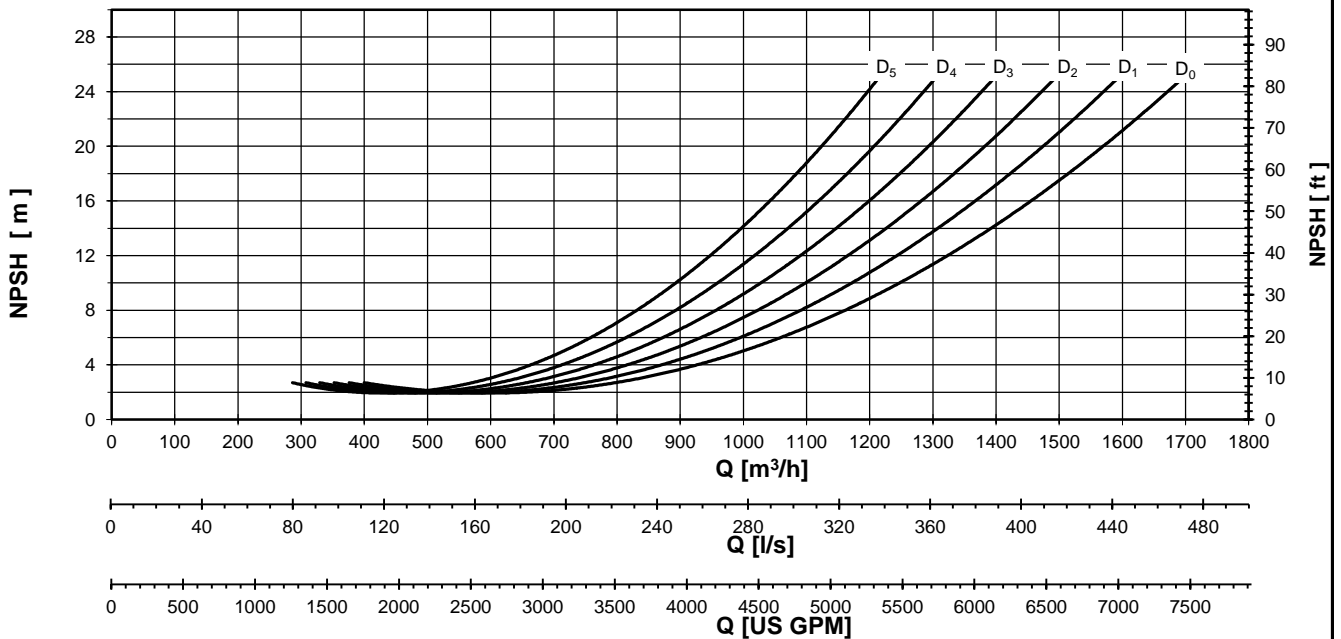
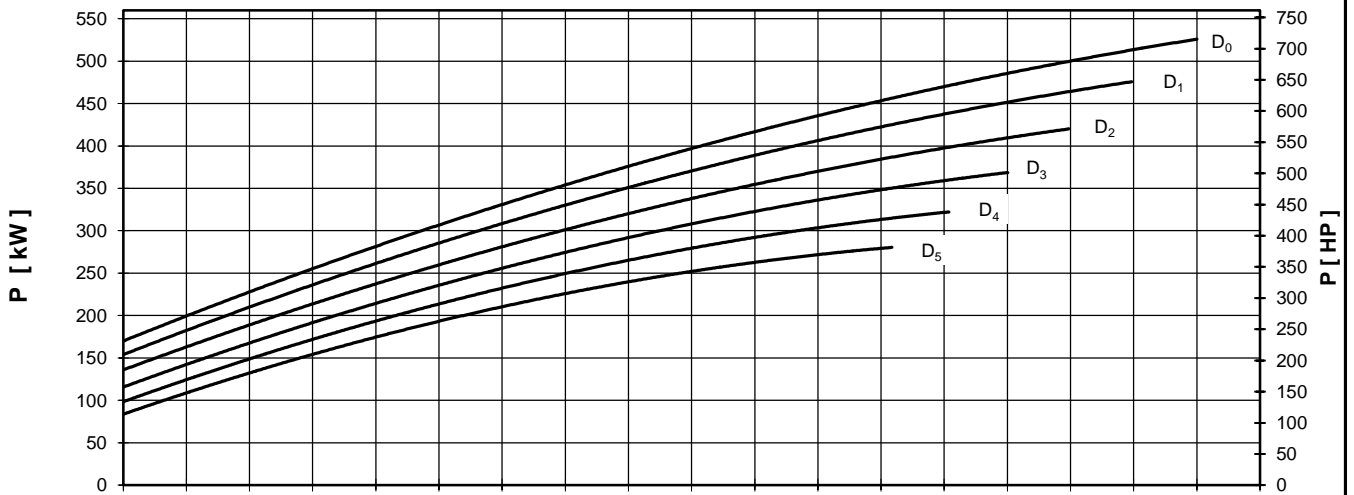
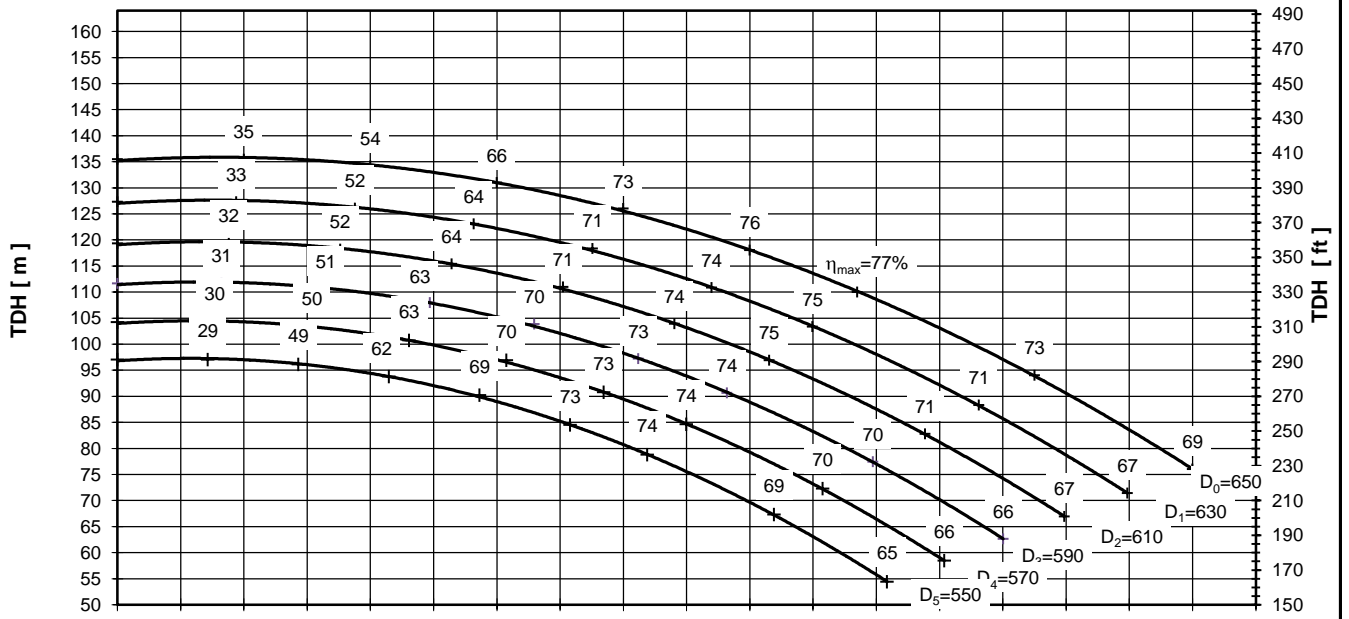

Performance curves are valid for clean cold water-kinematic viscosity 1 [mm²/s], density 1000 [kg/m³]. Methods and tolerances of presented performance curves are in accordance with ISO 9906 - Annex A



PUMP PERFORMANCE CURVES
No. 4HD.0184.03

PUMP TYPE
SCP 250 - 710
1450 [rpm]

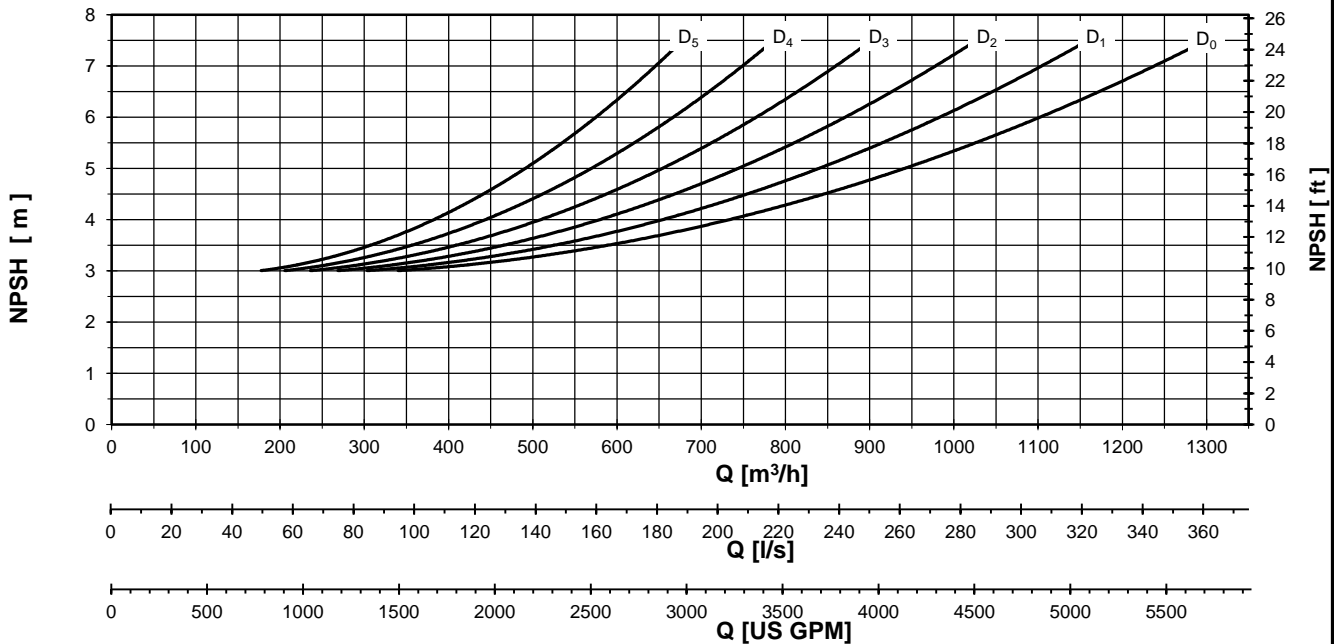
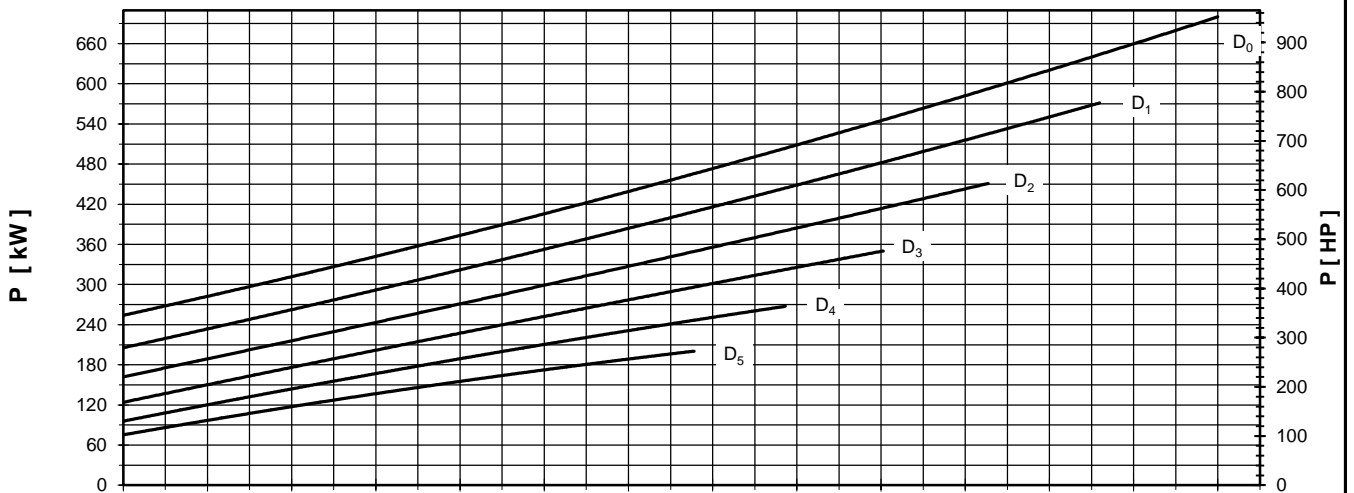
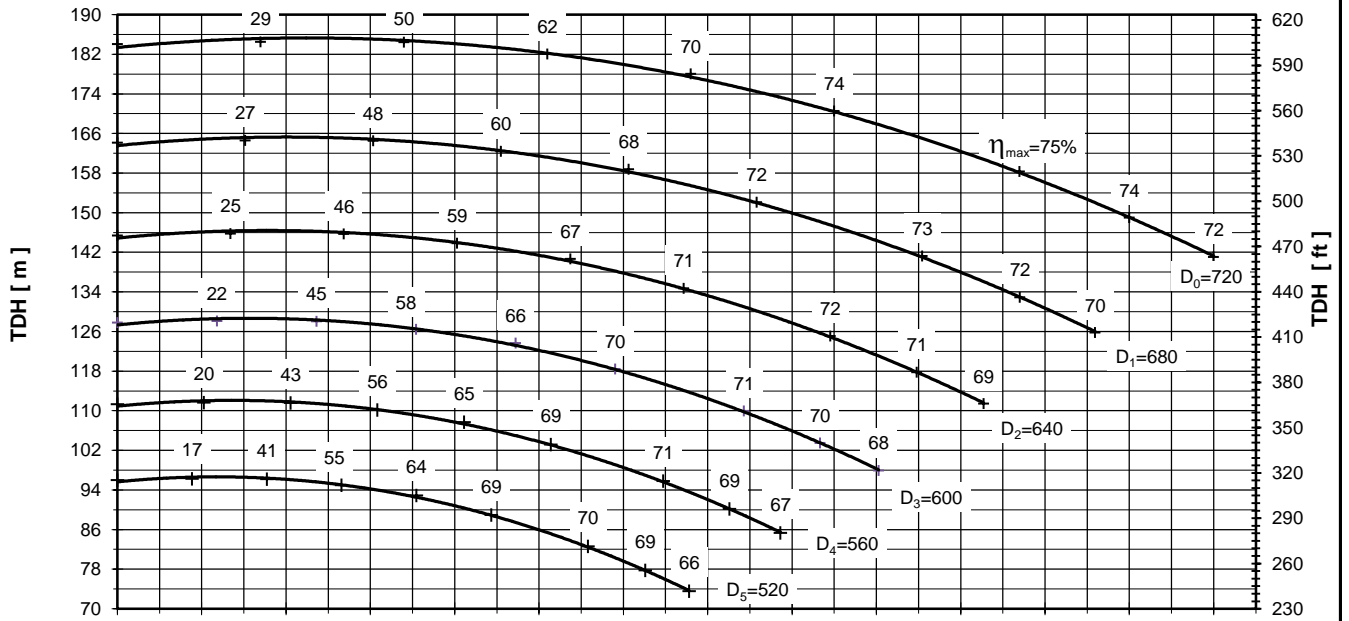

Performance curves are valid for clean cold water-kinematic viscosity 1 [mm²/s], density 1000 [kg/m³]. Methods and tolerances of presented performance curves are in accordance with ISO 9906 - Annex A



PUMP PERFORMANCE CURVES
No. 4HD.0185.03

PUMP TYPE
SCP 300 - 400
1450 [rpm]

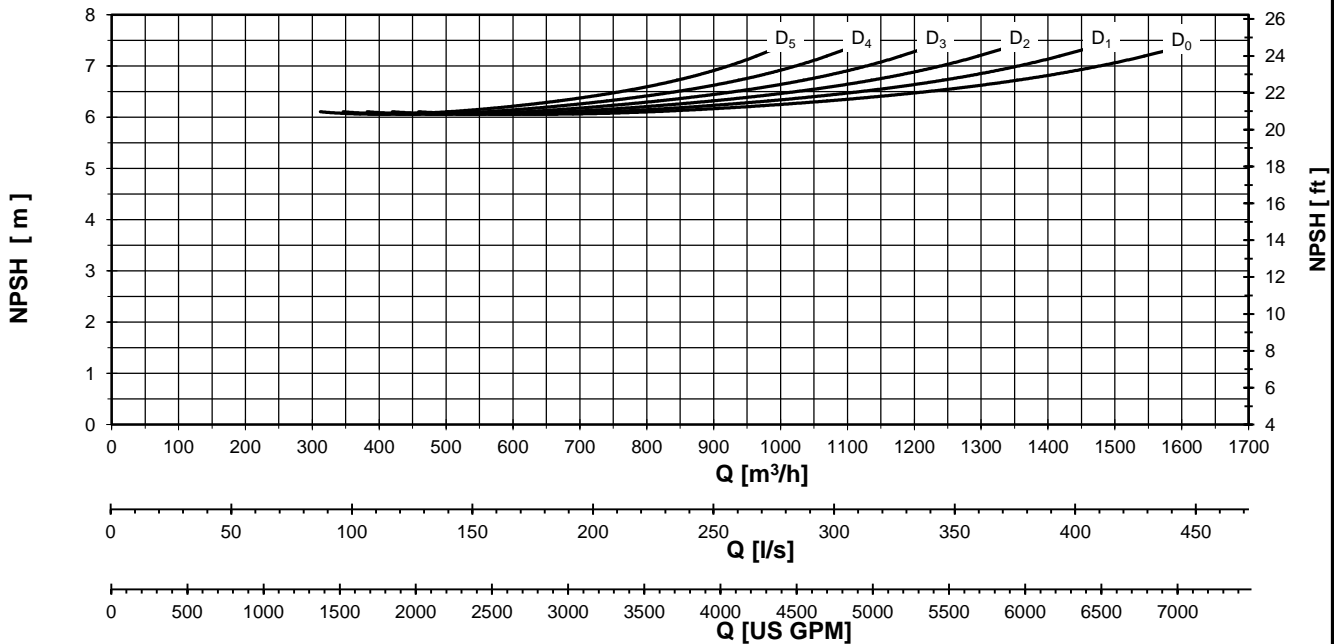
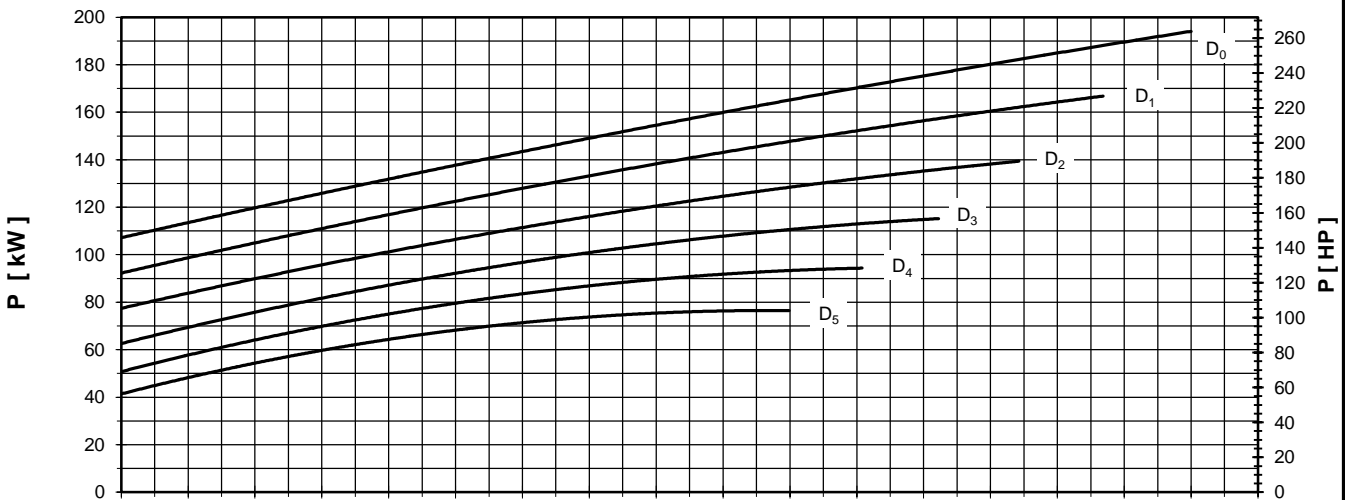
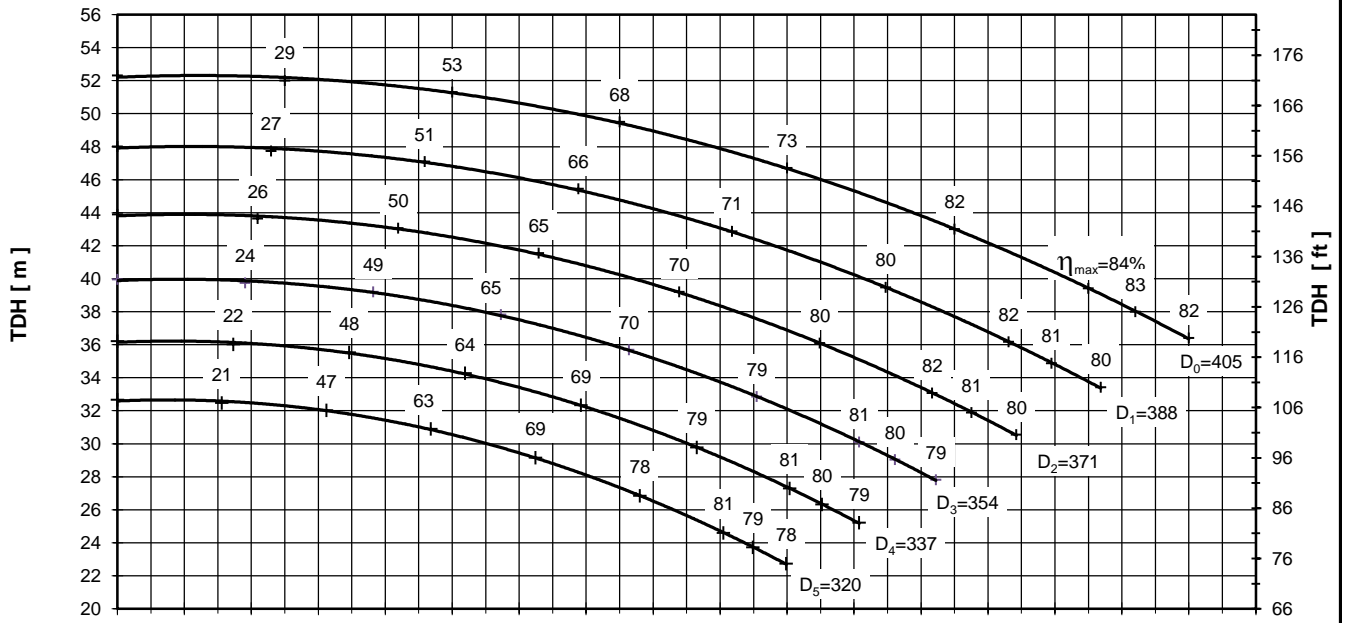

Performance curves are valid for clean cold water-kinematic viscosity 1 [mm²/s], density 1000 [kg/m³]. Methods and tolerances of presented performance curves are in accordance with ISO 9906 - Annex A

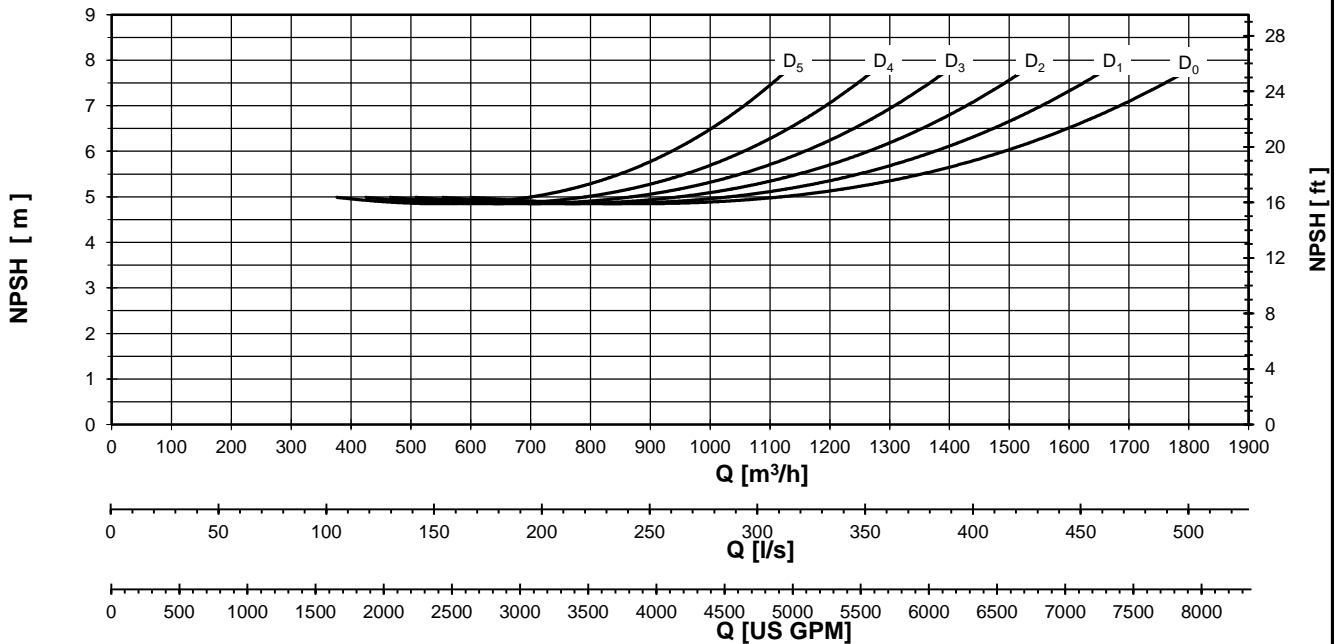
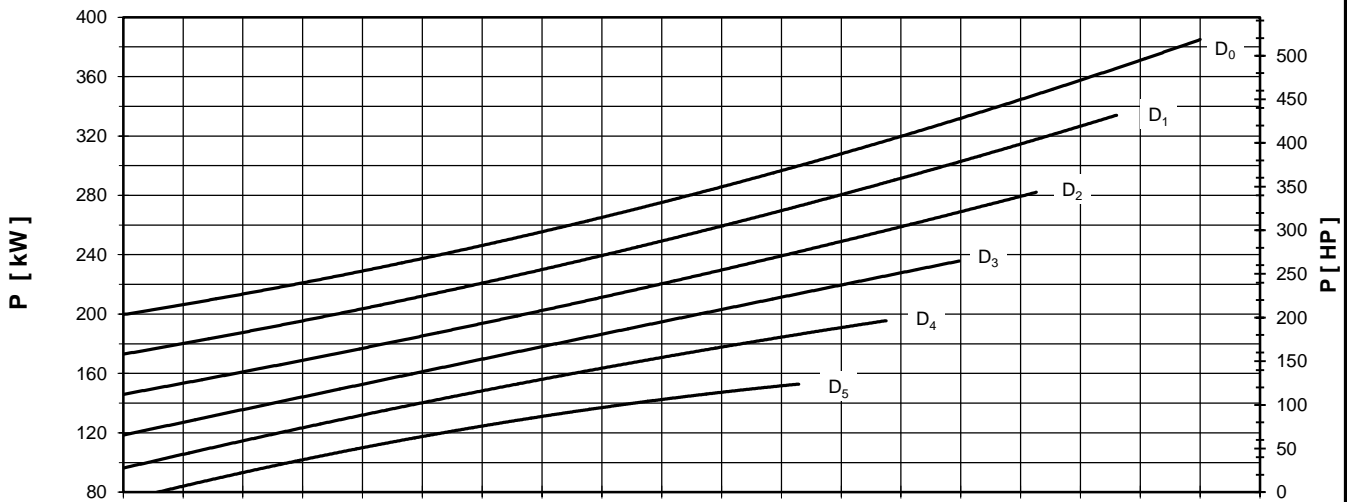
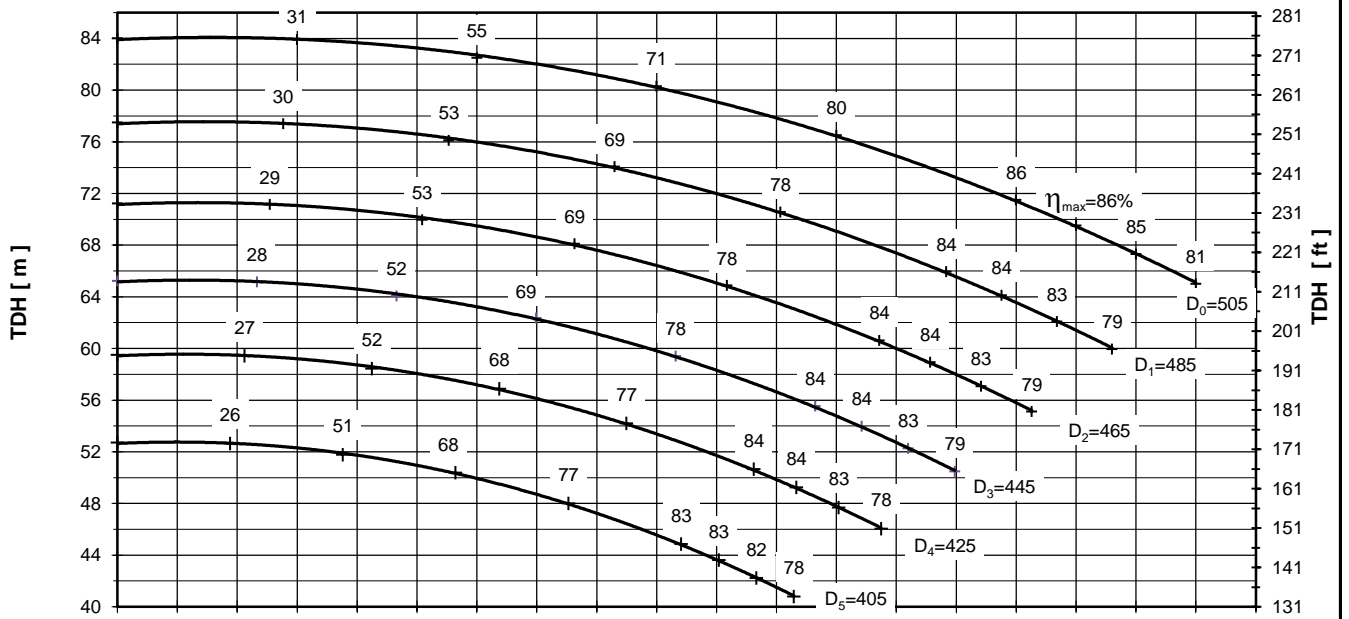

Performance curves are valid for clean cold water-kinematic viscosity 1 [mm²/s], density 1000 [kg/m³]. Methods and tolerances of presented performance curves are in accordance with ISO 9906 - Annex A

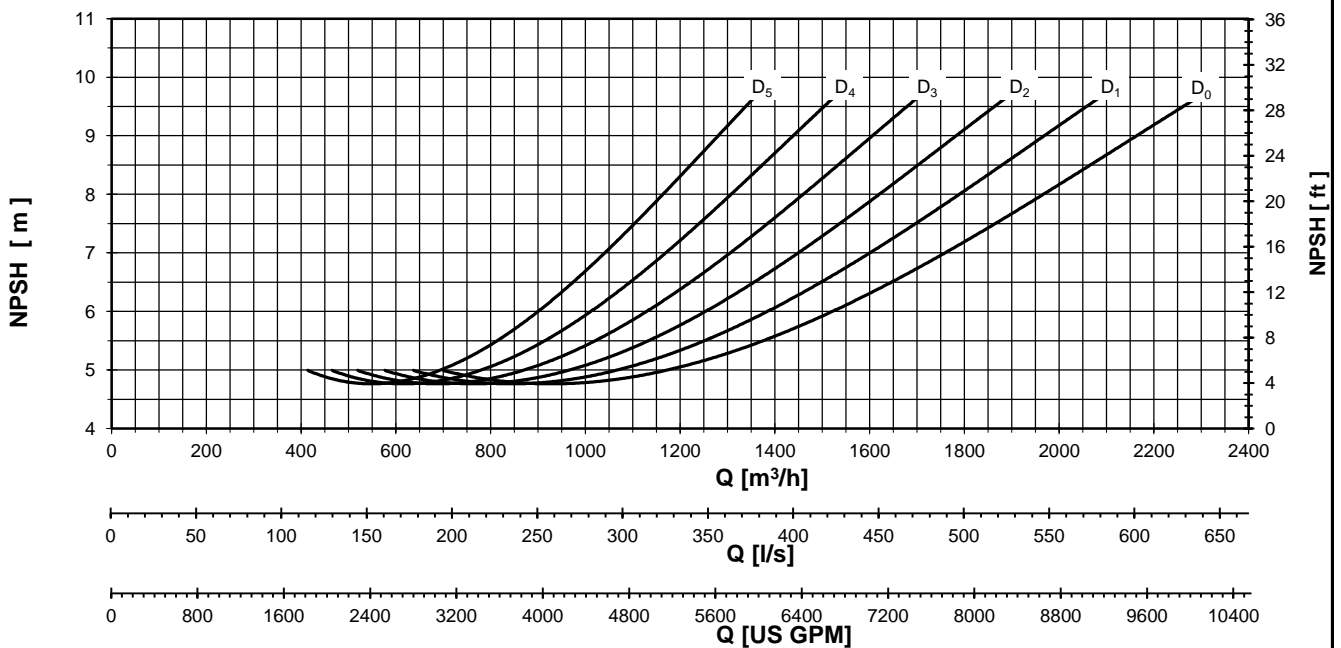
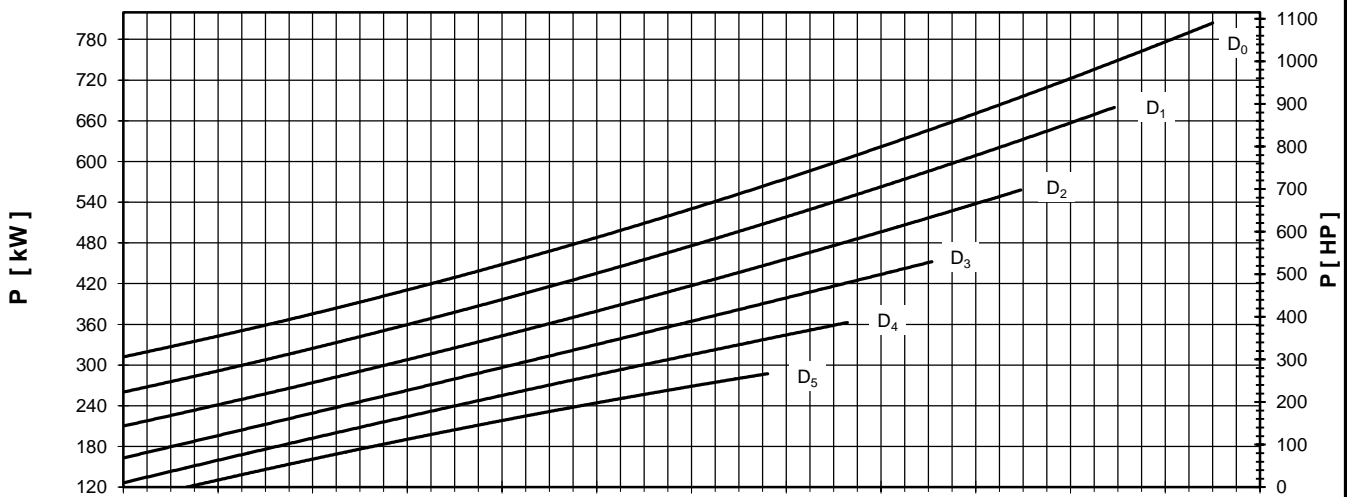
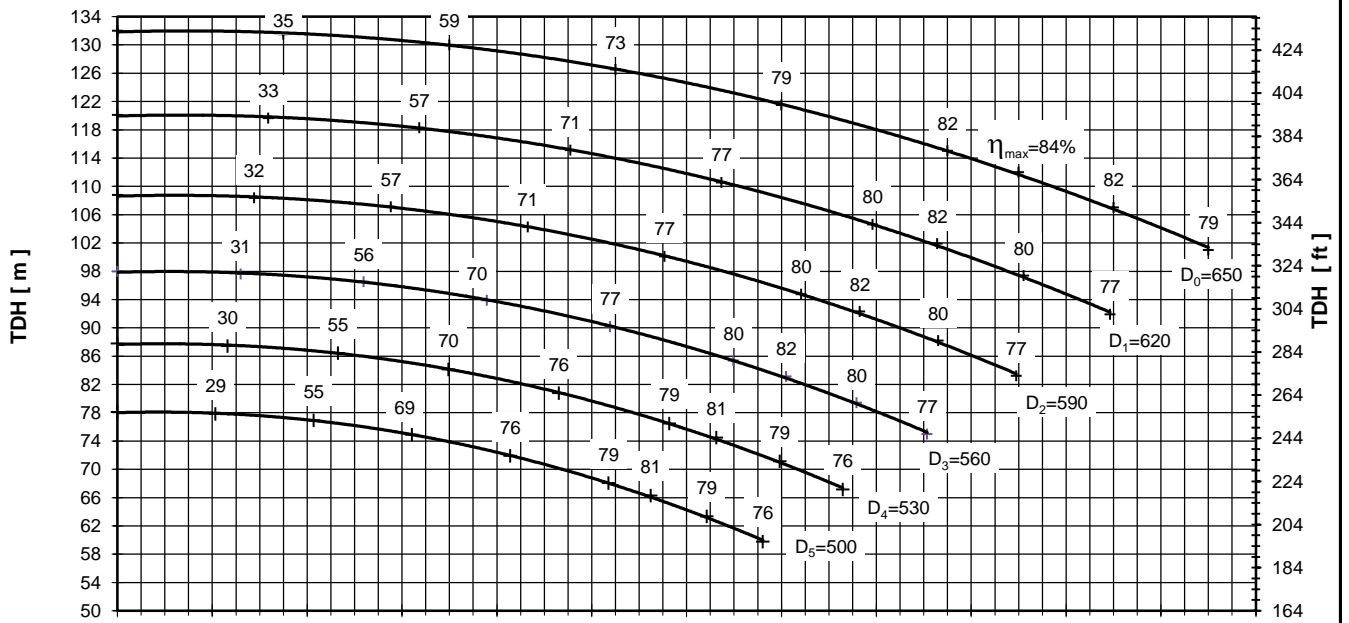

Performance curves are valid for clean cold water-kinematic viscosity 1 [mm²/s], density 1000 [kg/m³]. Methods and tolerances of presented performance curves are in accordance with ISO 9906 - Annex A

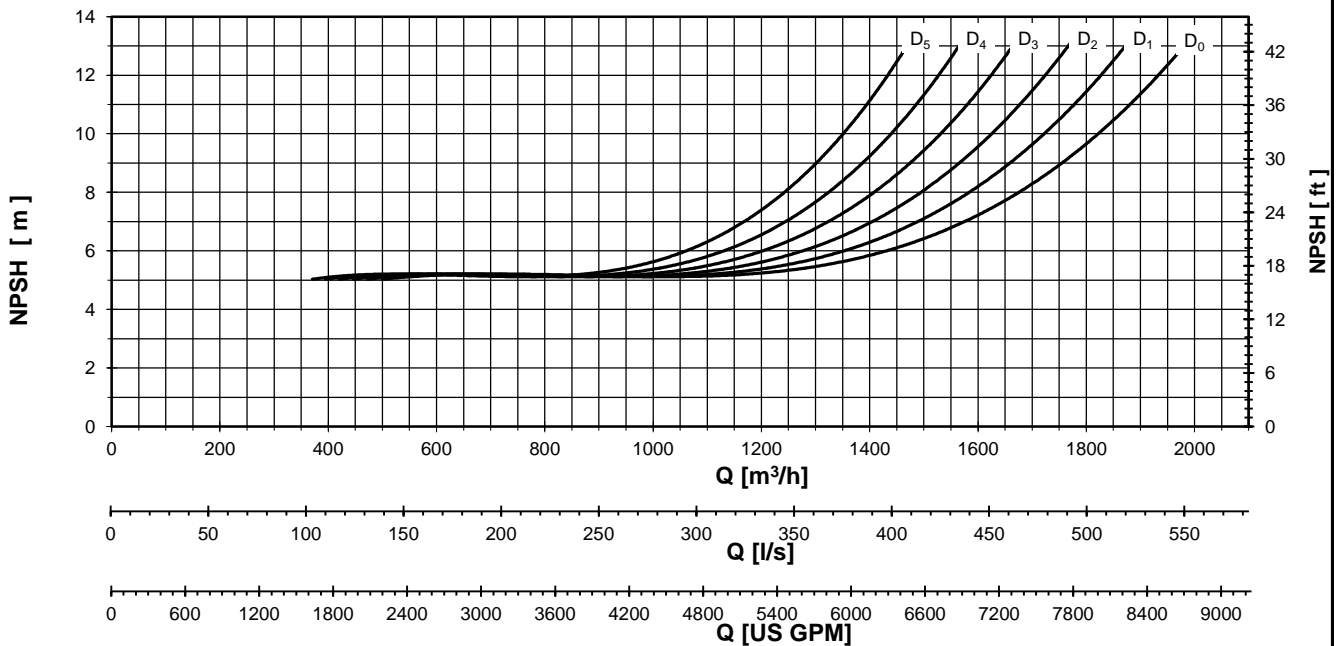
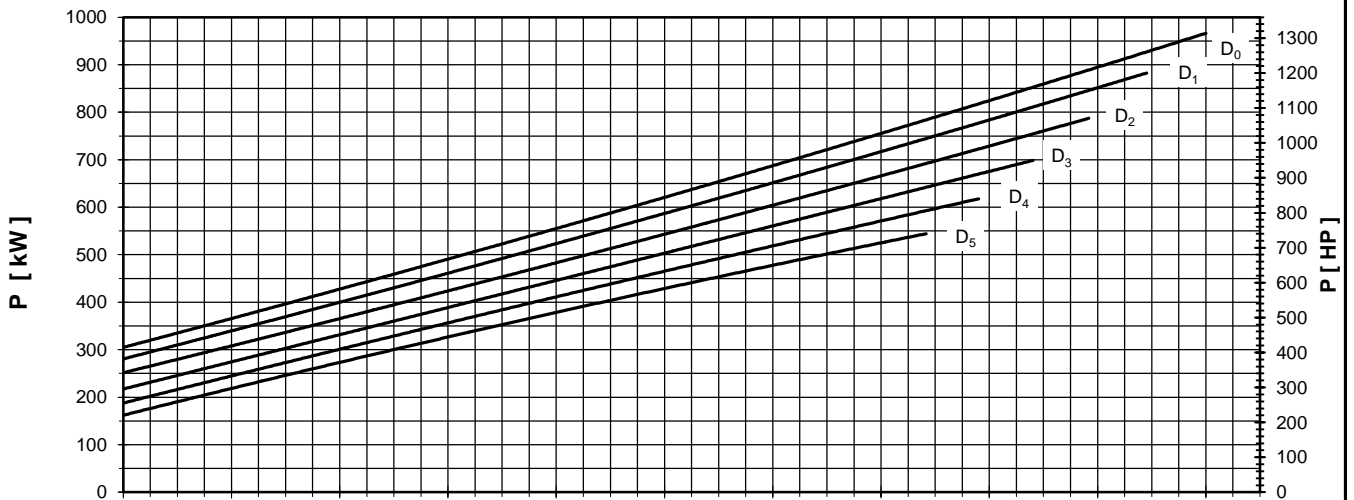
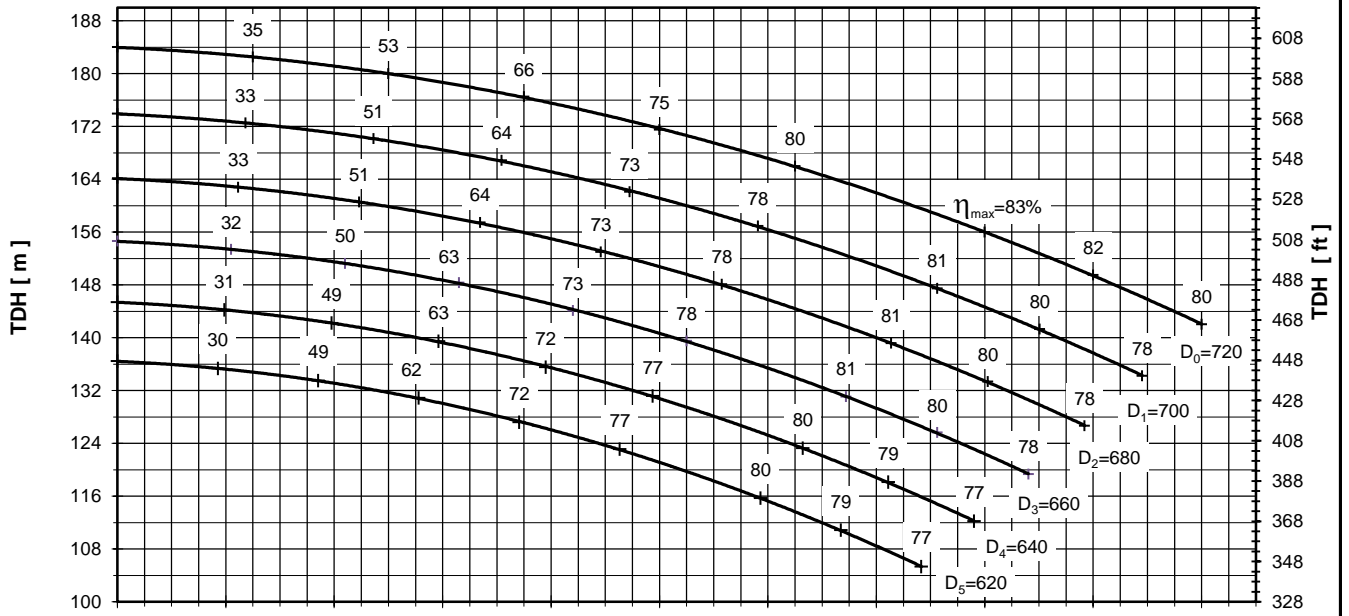



PUMP PERFORMANCE CURVES
No. 4HD.0189.03

PUMP TYPE
SCP 350 - 400
1450 [rpm]

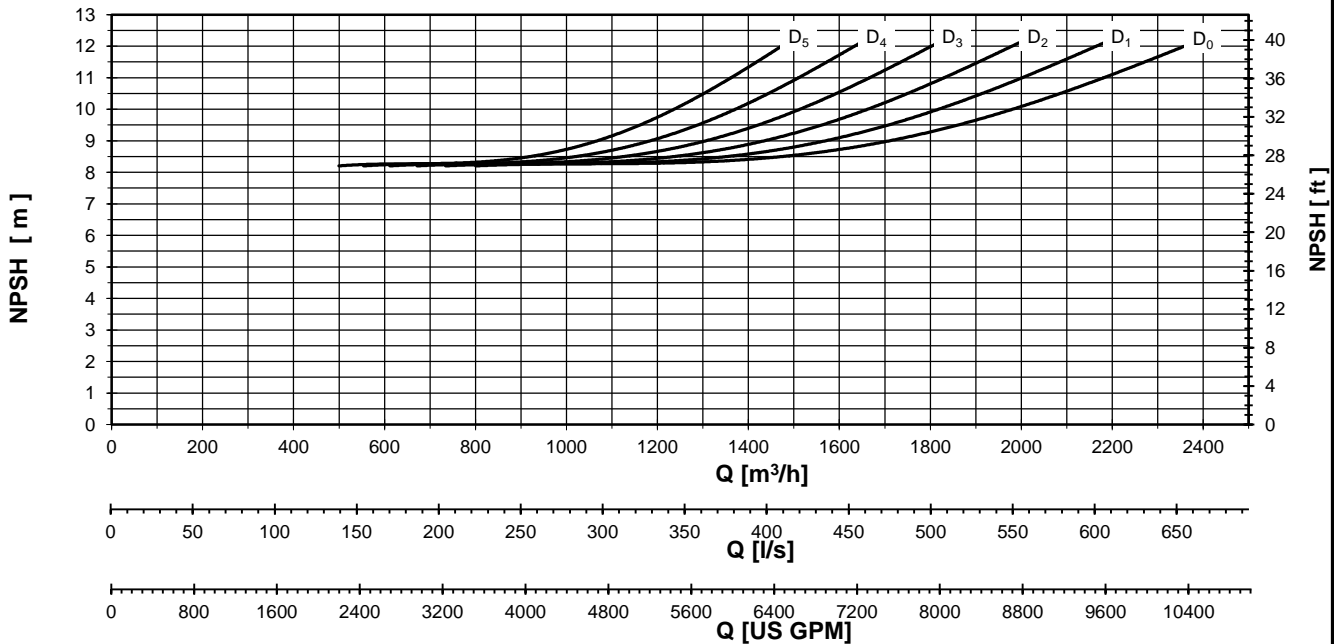
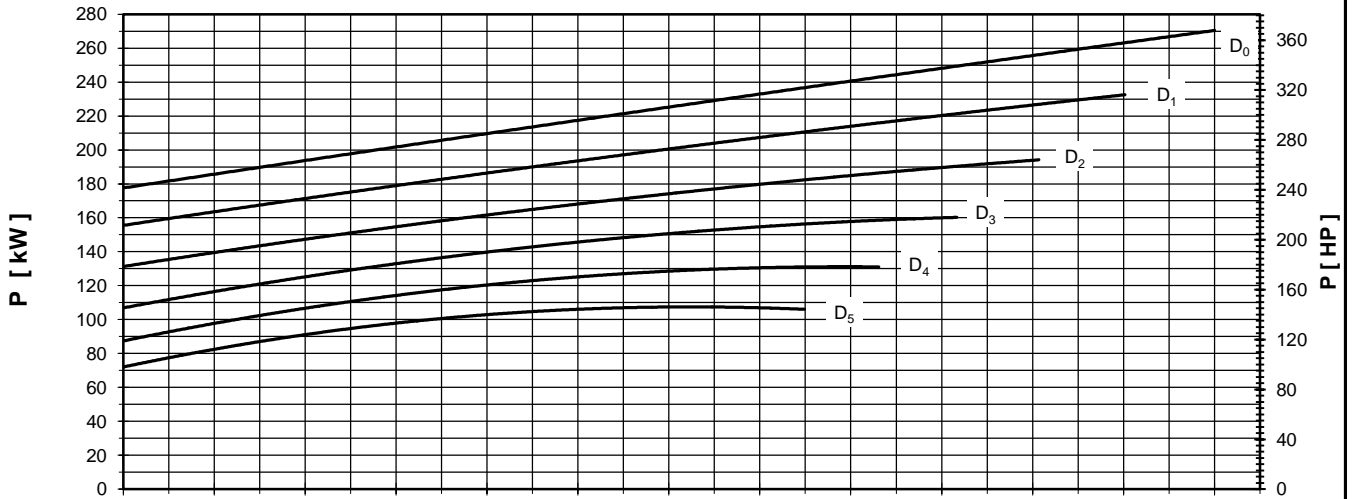
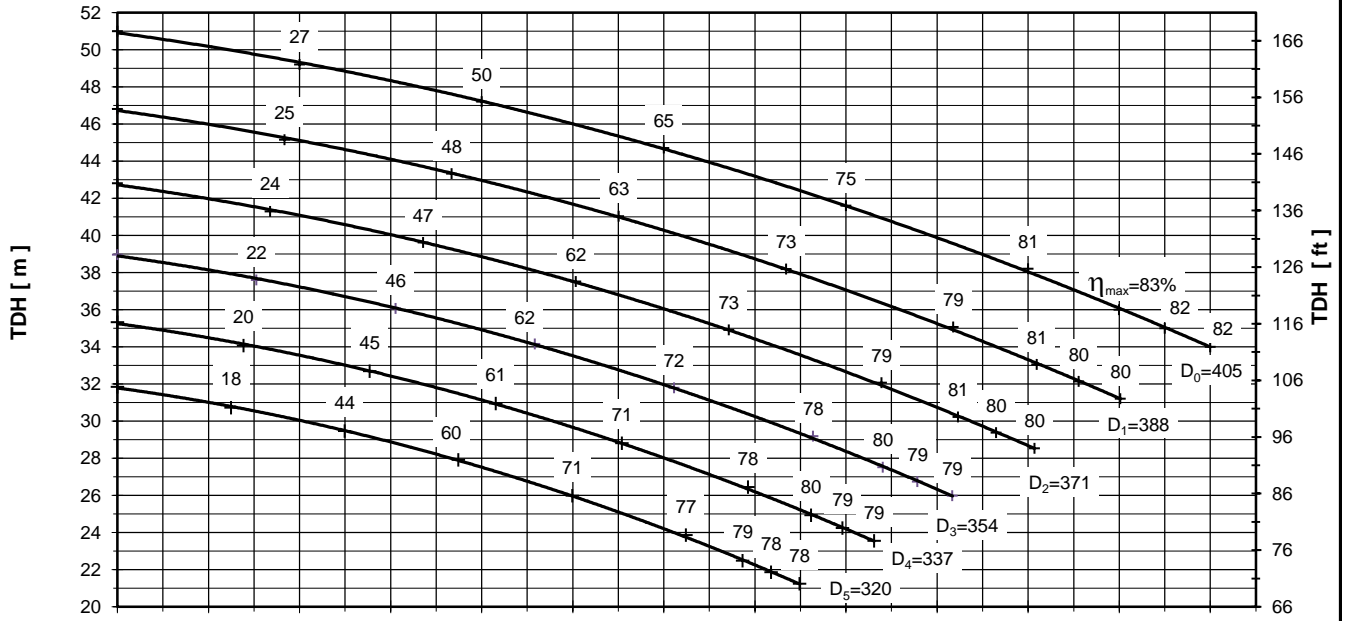

Performance curves are valid for clean cold water-kinematic viscosity 1 [mm²/s], density 1000 [kg/m³]. Methods and tolerances of presented performance curves are in accordance with ISO 9906 - Annex A

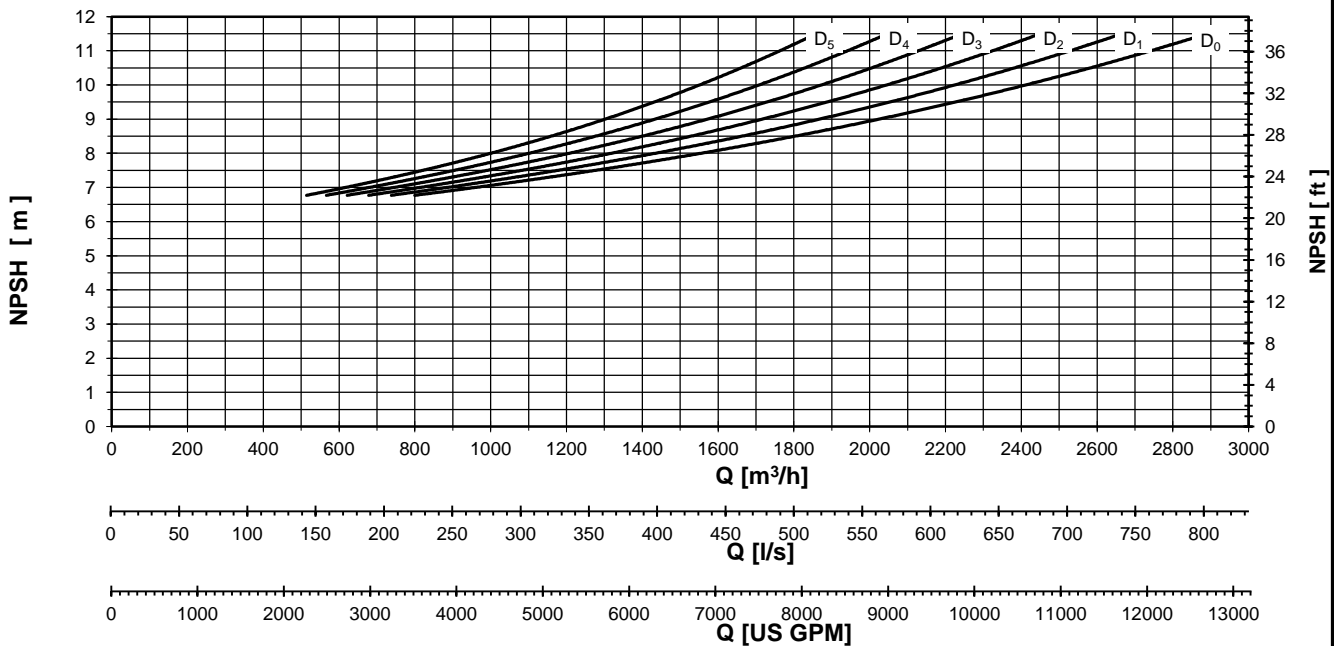
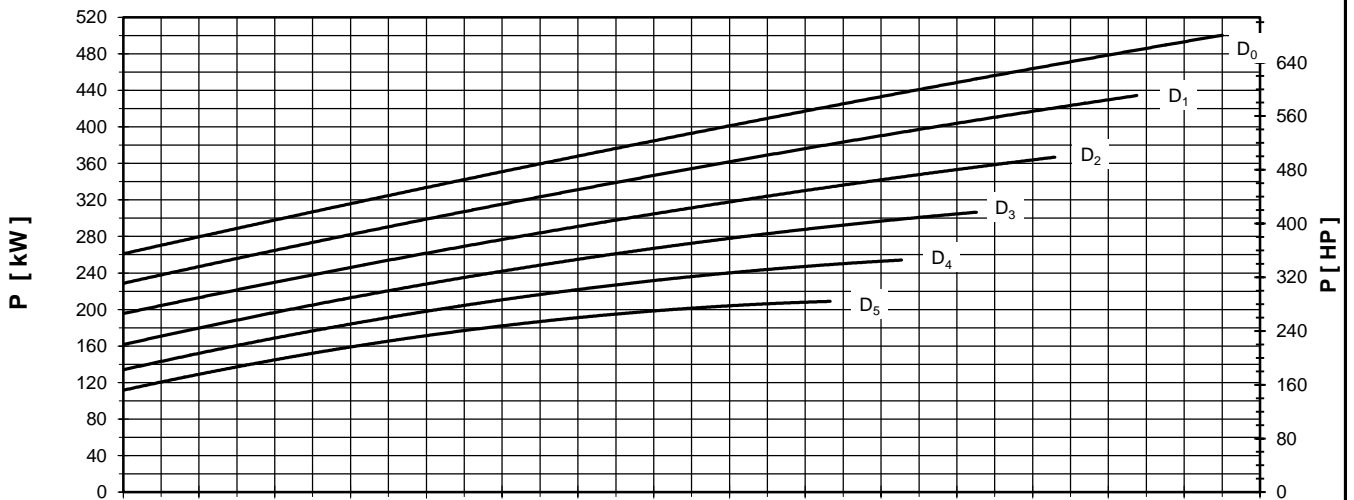
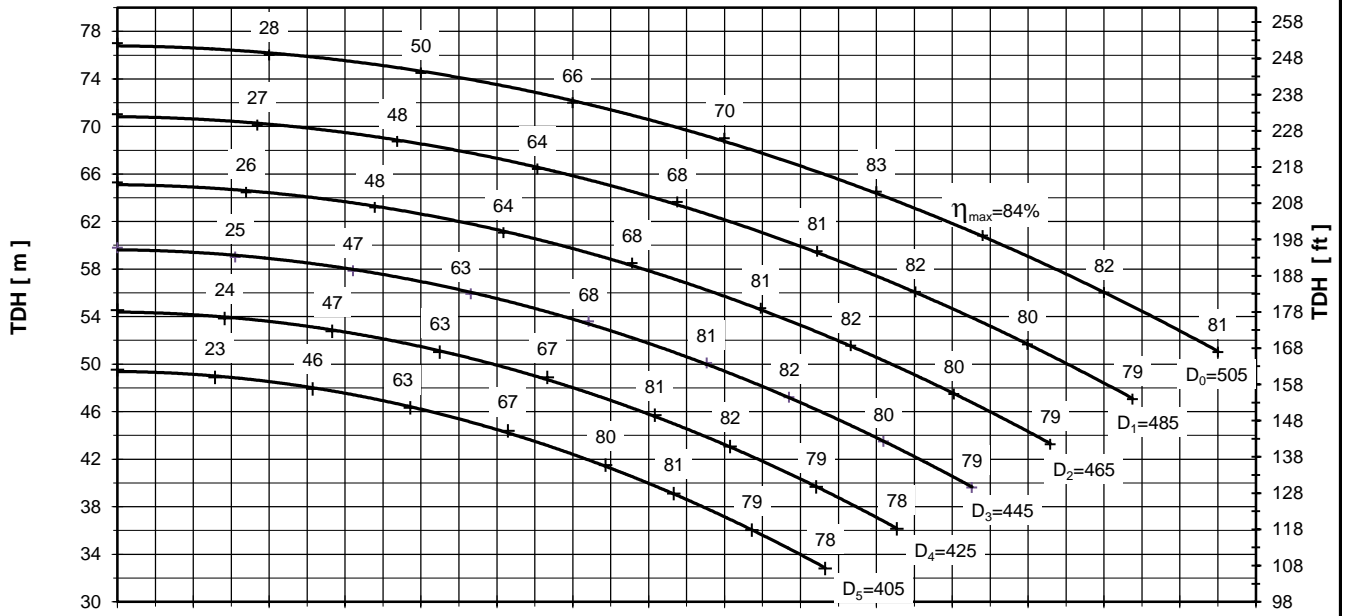

Performance curves are valid for clean cold water-kinematic viscosity 1 [mm²/s], density 1000 [kg/m³]. Methods and tolerances of presented performance curves are in accordance with ISO 9906 - Annex A

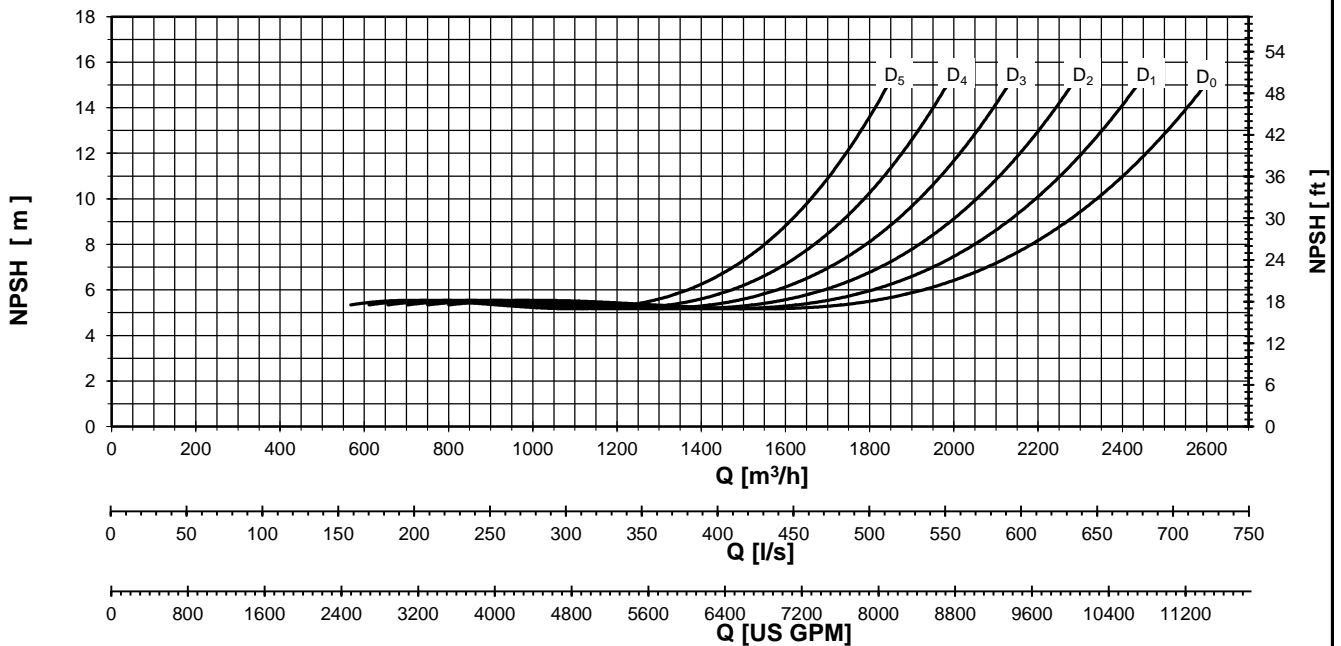
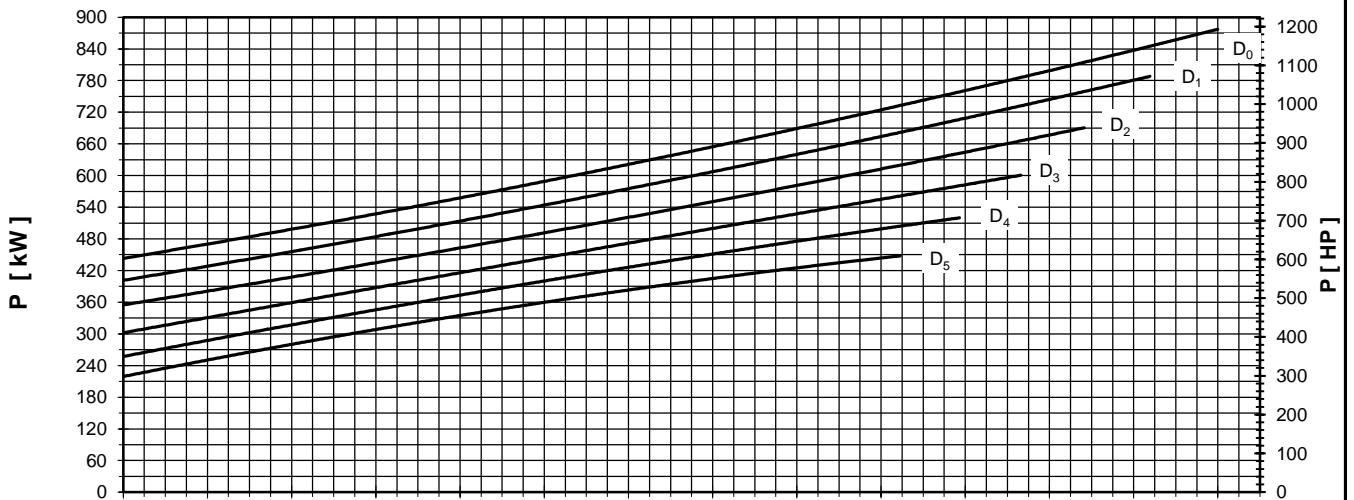
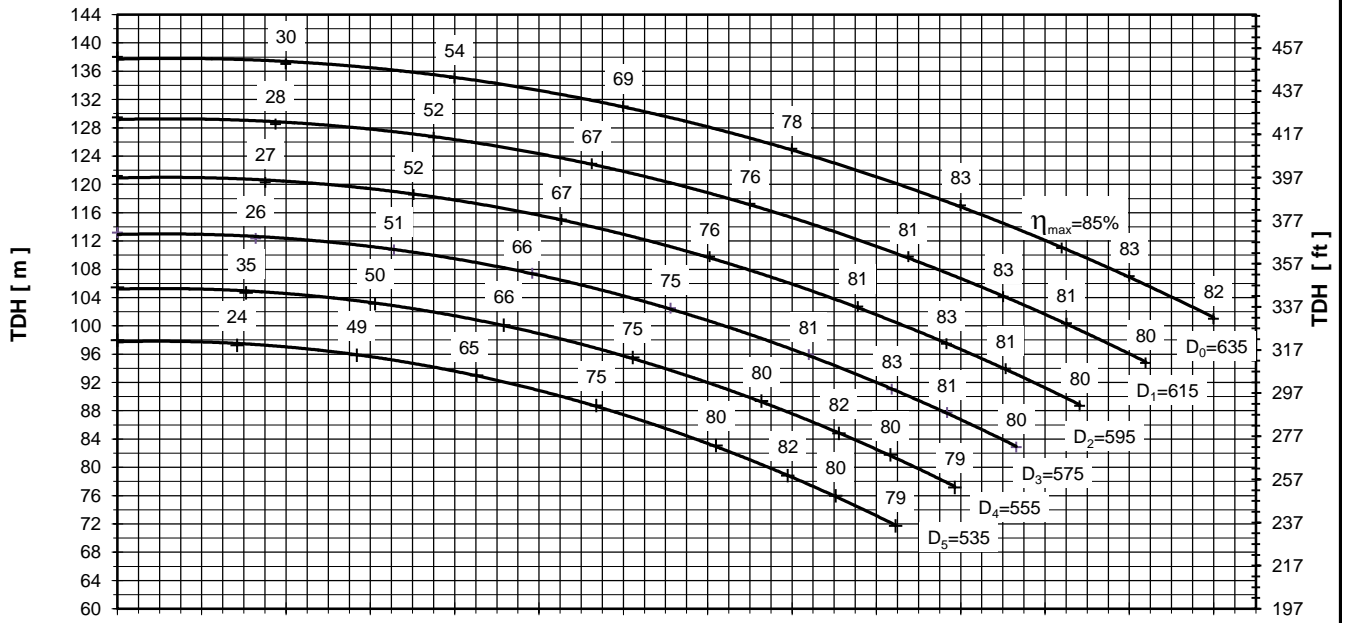



PUMP PERFORMANCE CURVES
No. 4HD.0192.03

PUMP TYPE
SCP 350 - 710
1450 [rpm]

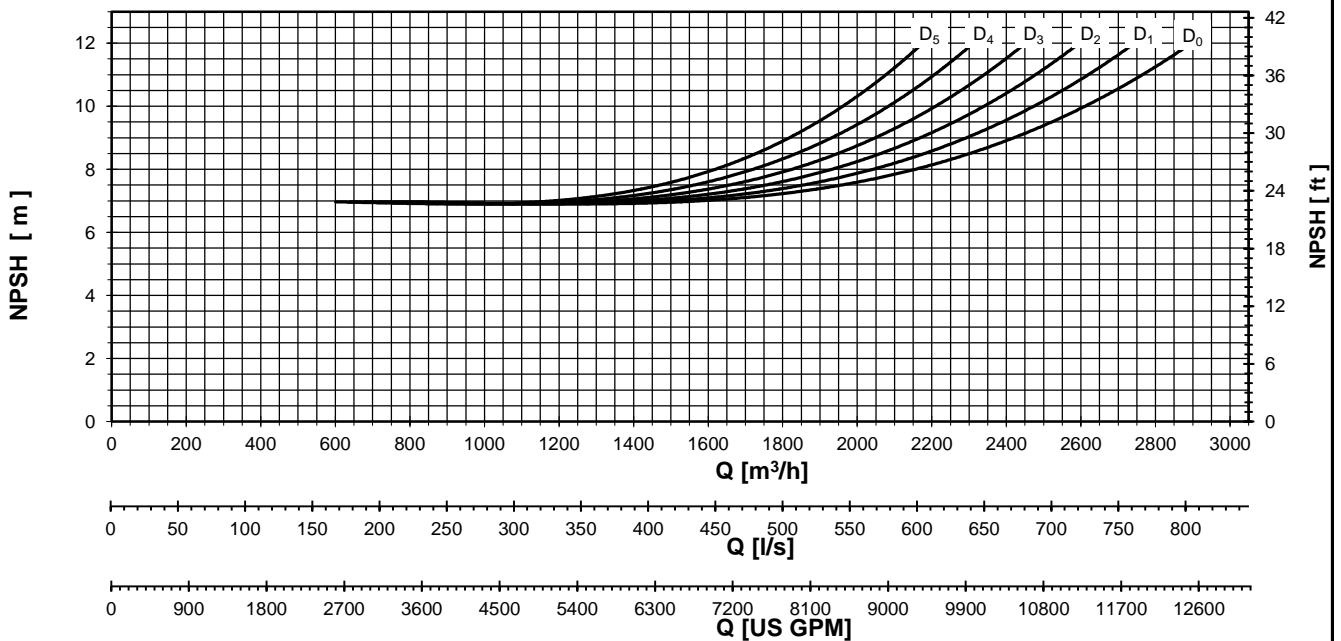
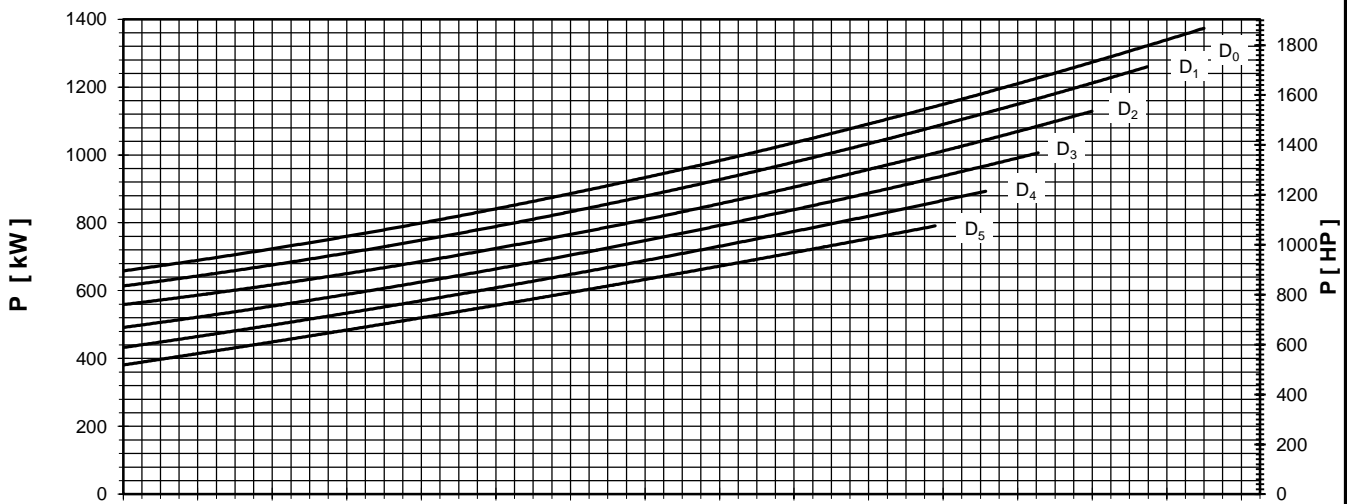
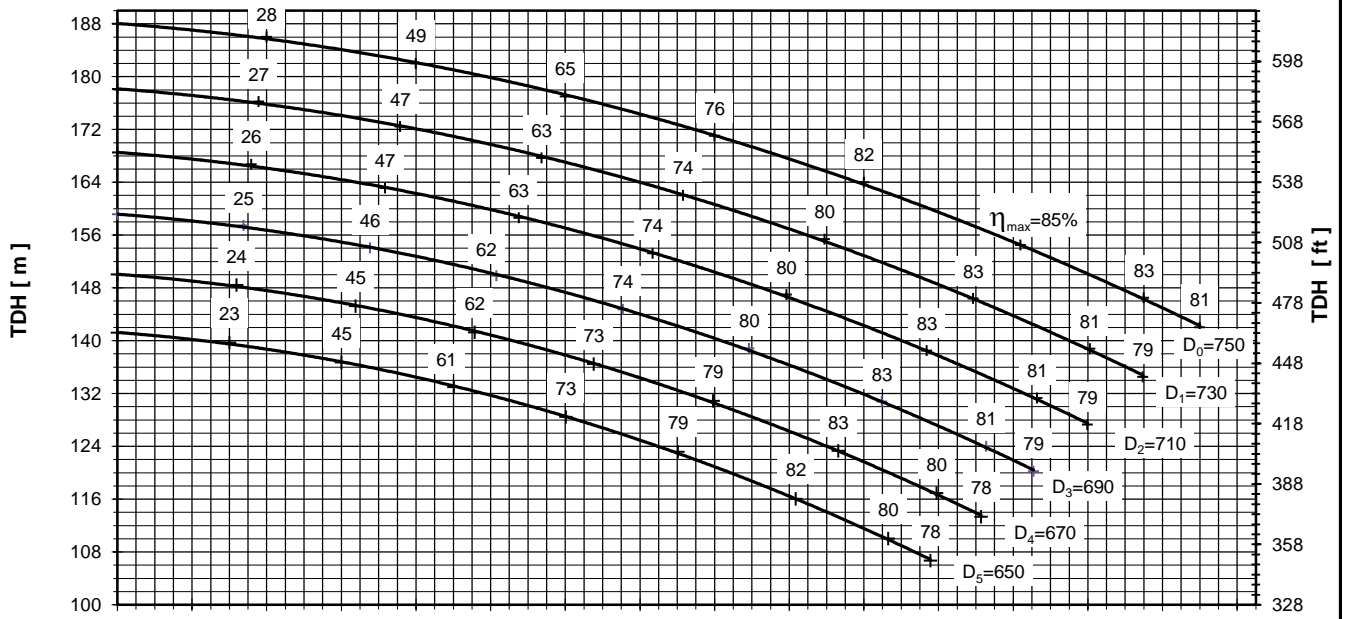

Performance curves are valid for clean cold water-kinematic viscosity 1 [mm²/s], density 1000 [kg/m³]. Methods and tolerances of presented performance curves are in accordance with ISO 9906 - Annex A

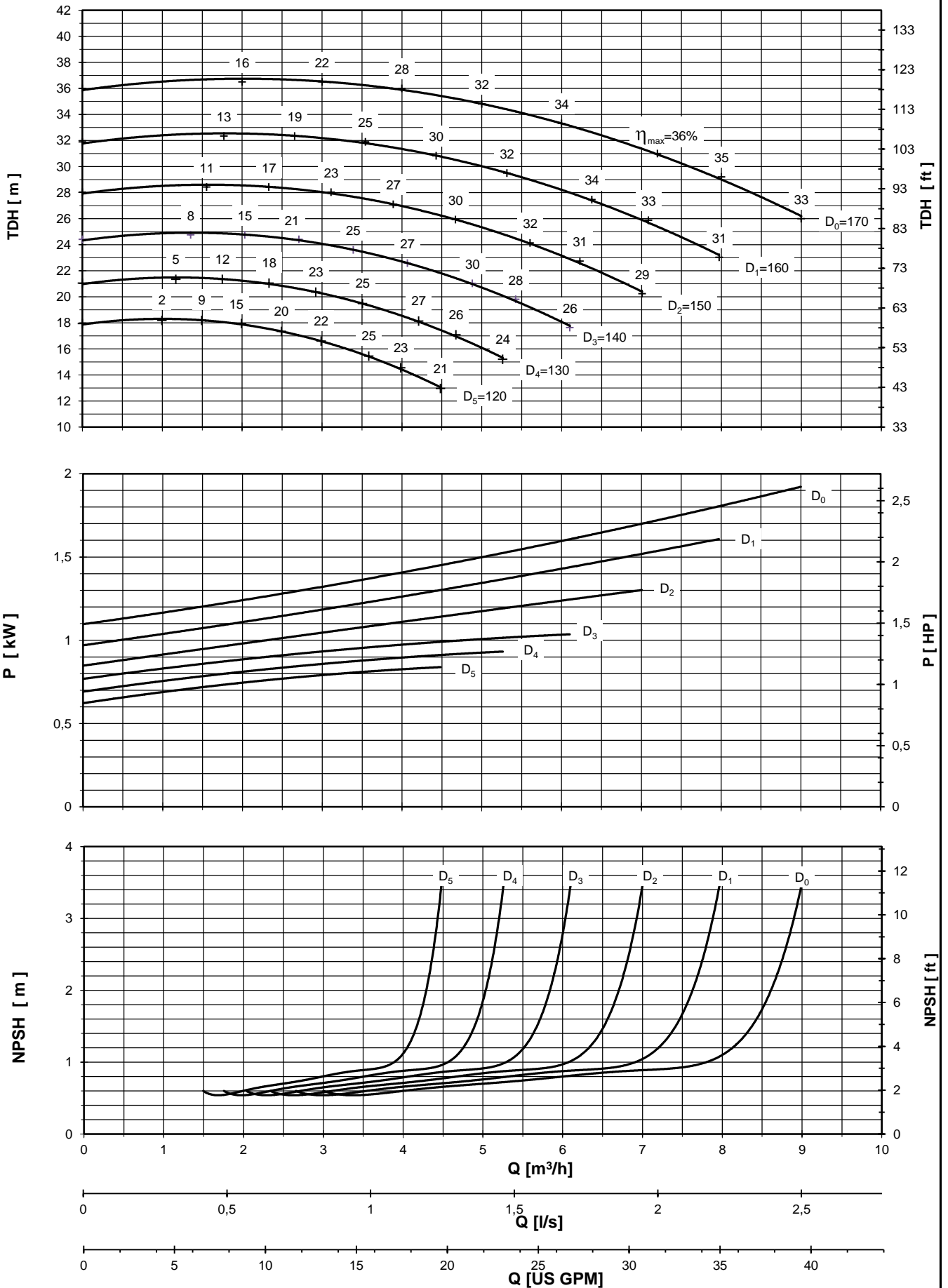

Performance curves are valid for clean cold water-kinematic viscosity 1 [mm²/s], density 1000 [kg/m³]. Methods and tolerances of presented performance curves are in accordance with ISO 9906 - Annex A

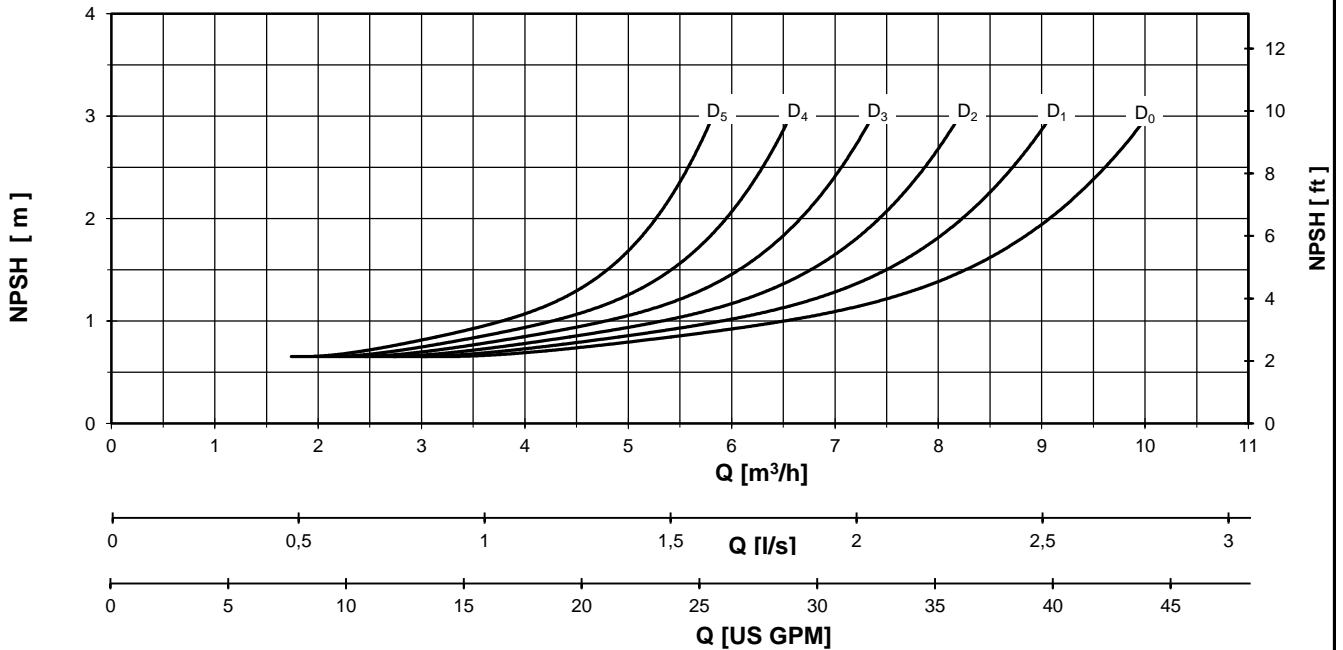
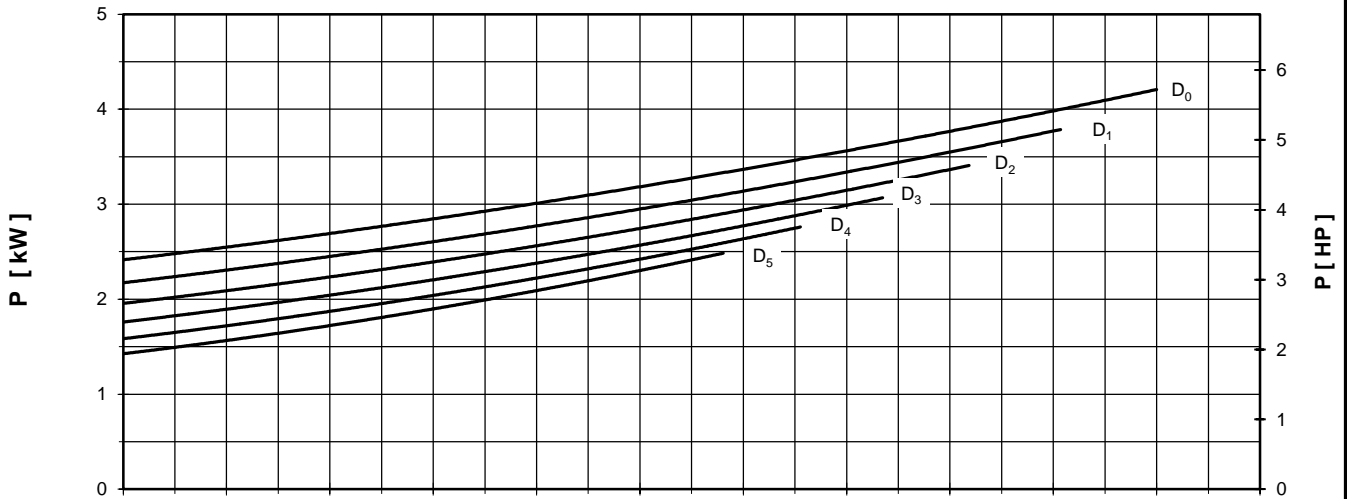
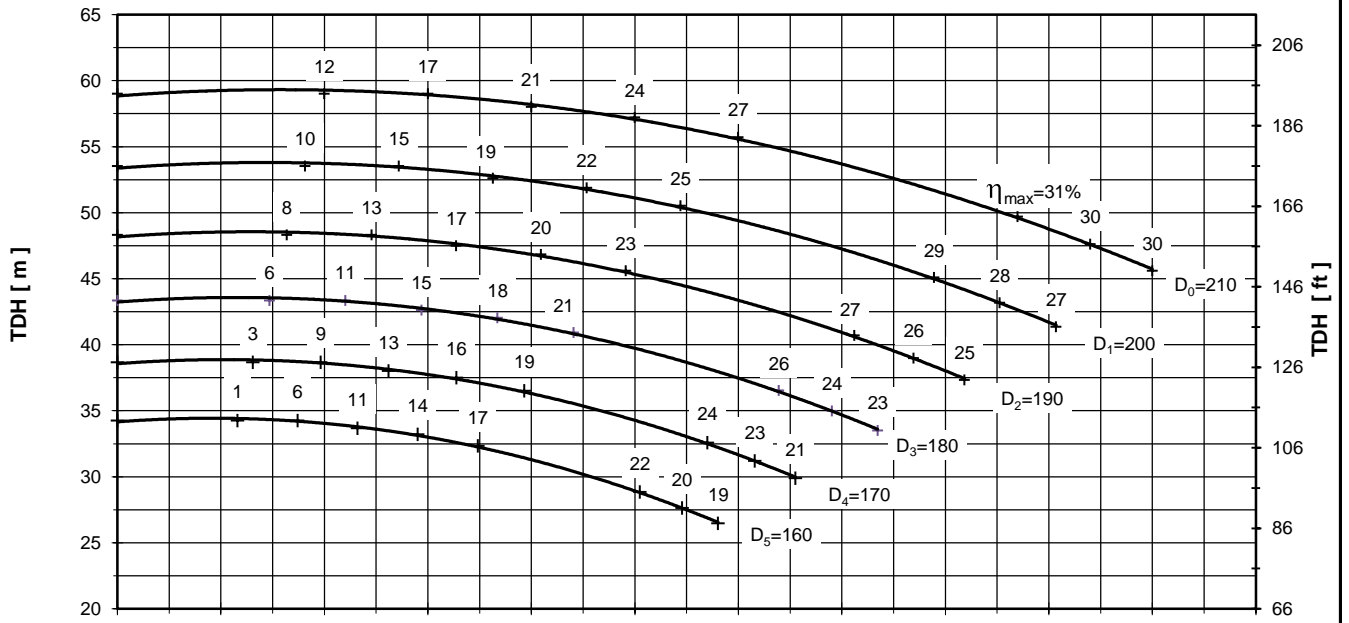

Performance curves are valid for clean cold water-kinematic viscosity 1 [mm²/s], density 1000 [kg/m³]. Methods and tolerances of presented performance curves are in accordance with ISO 9906 - Annex A

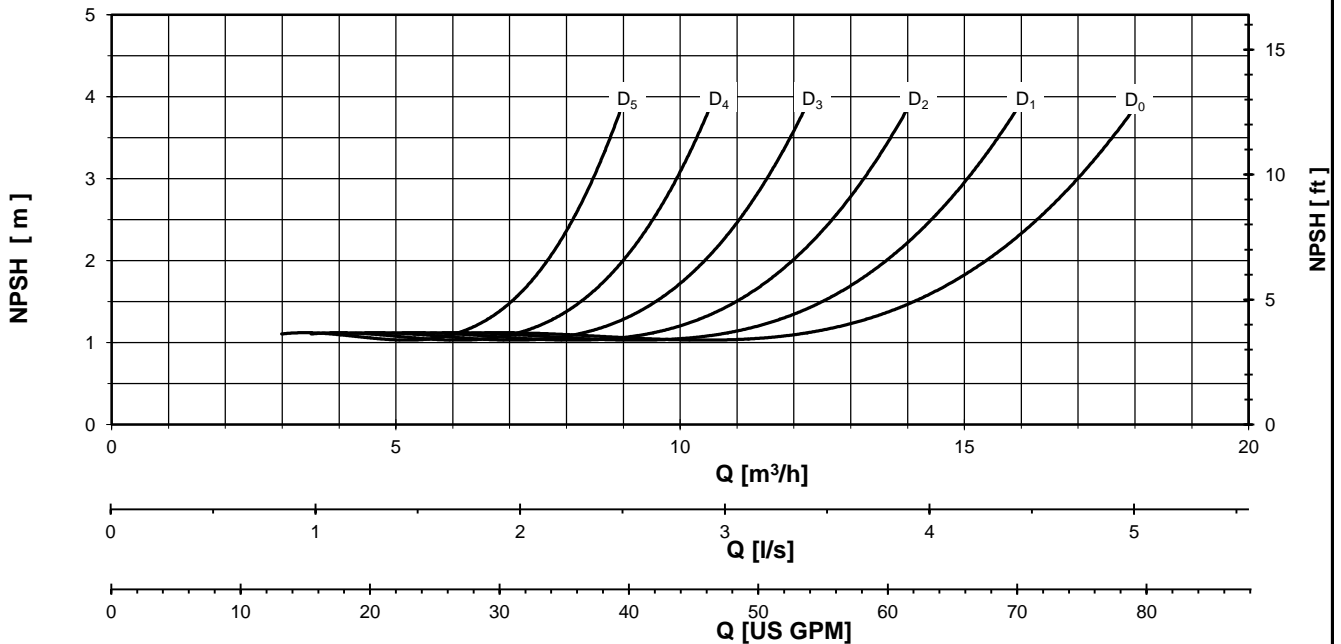
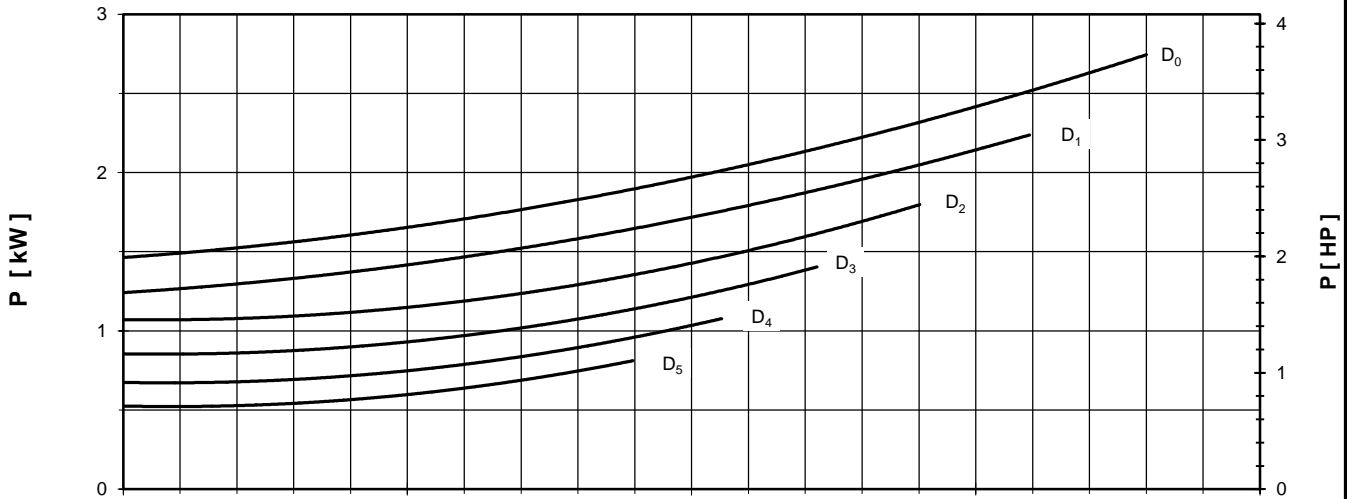
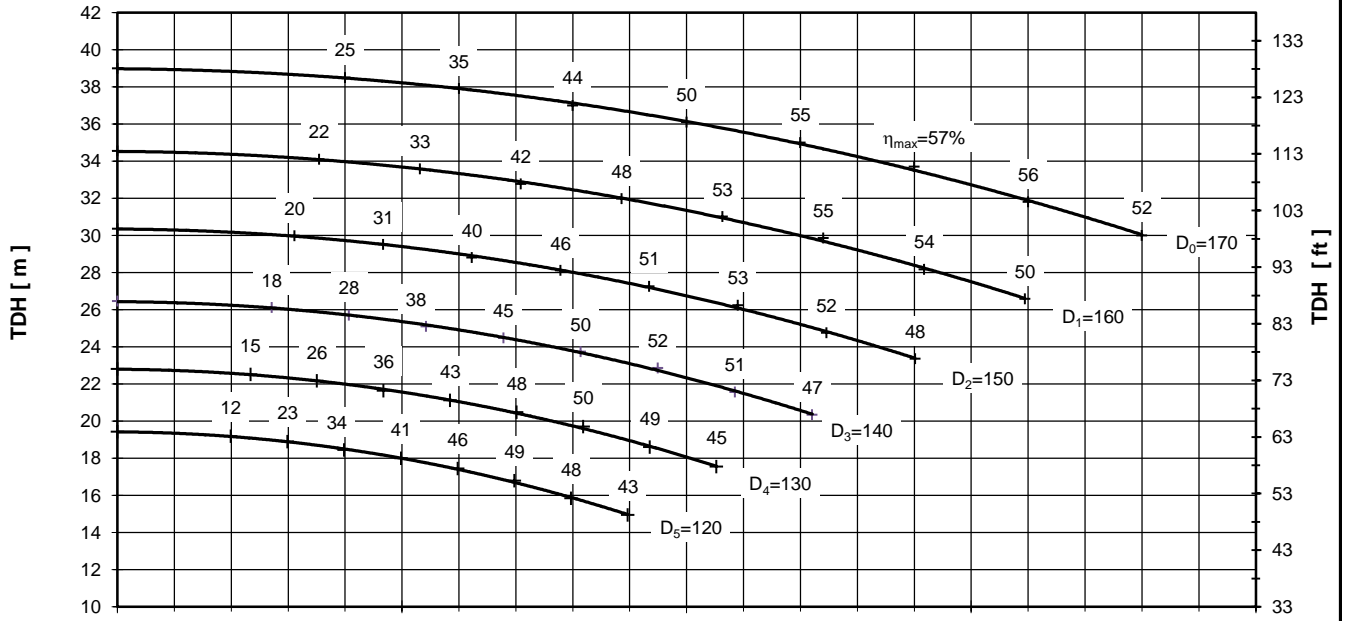



PUMP PERFORMANCE CURVES
No. 4HD.0143.05

PUMP TYPE
SCP 32 - 200
2900 [rpm]

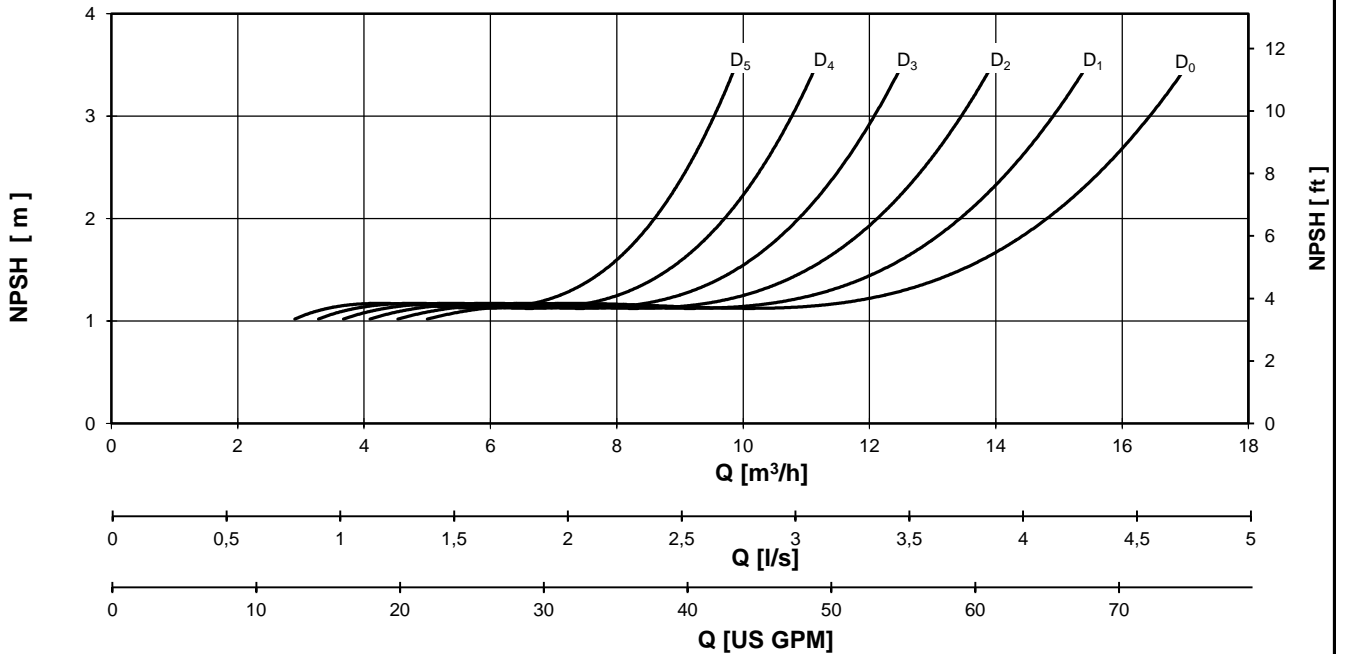
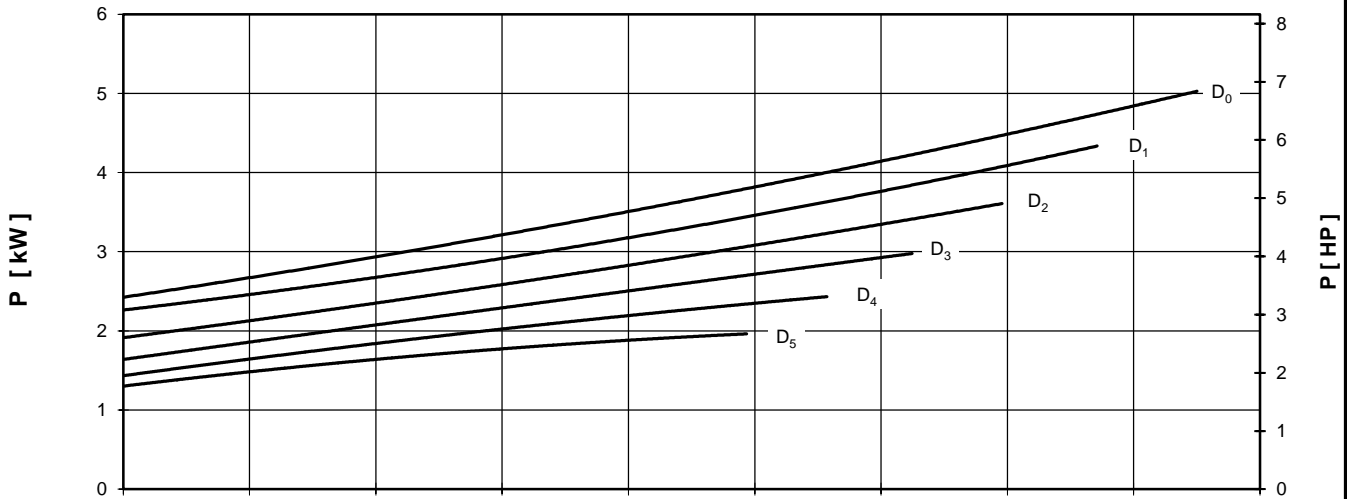
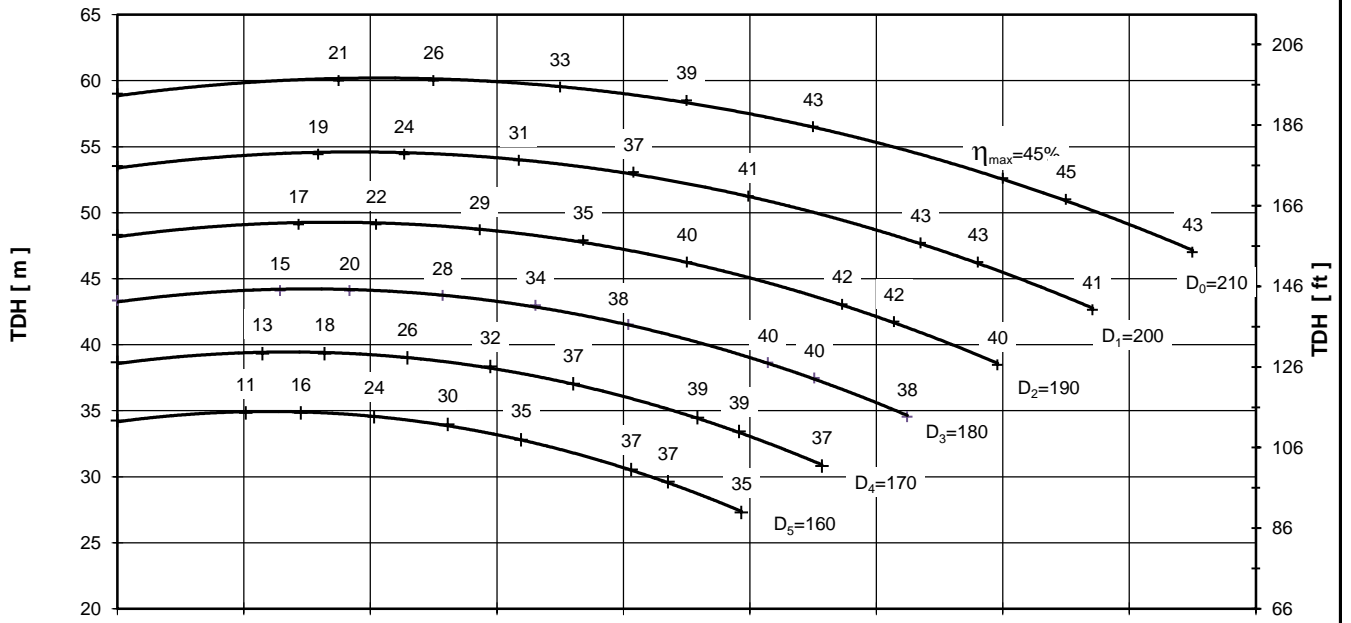

Performance curves are valid for clean cold water-kinematic viscosity 1 [mm²/s], density 1000 [kg/m³]. Methods and tolerances of presented performance curves are in accordance with ISO 9906 - Annex A

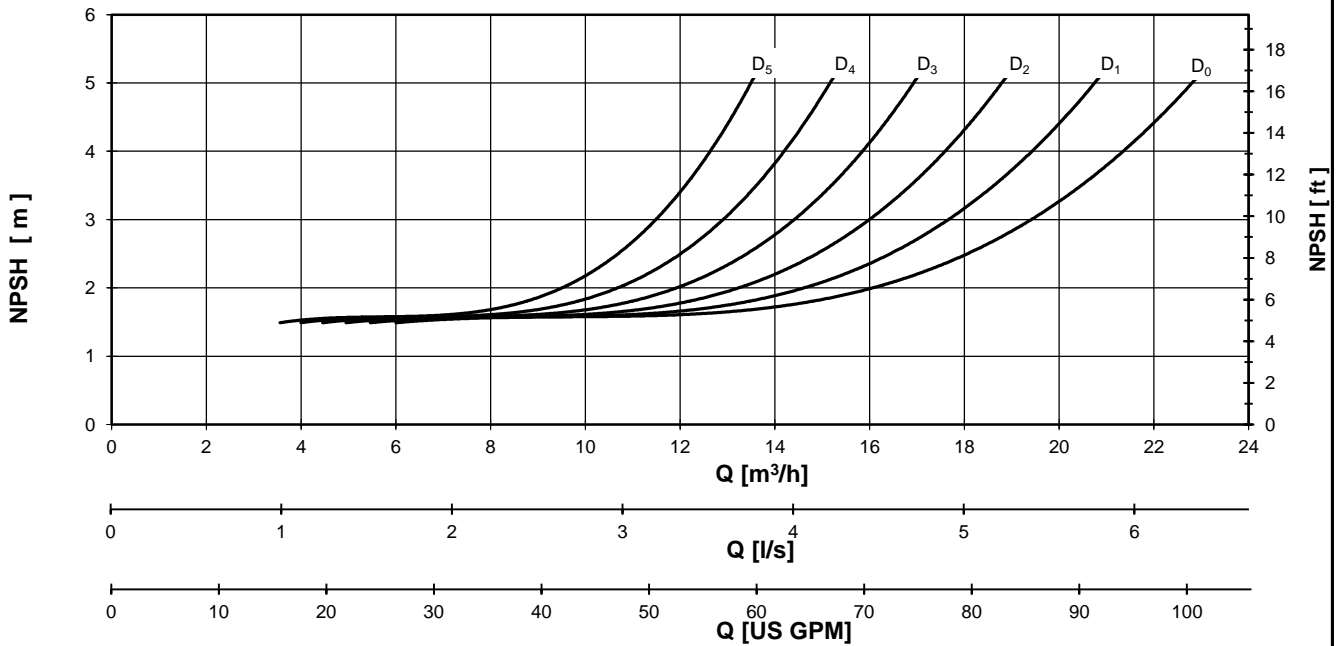
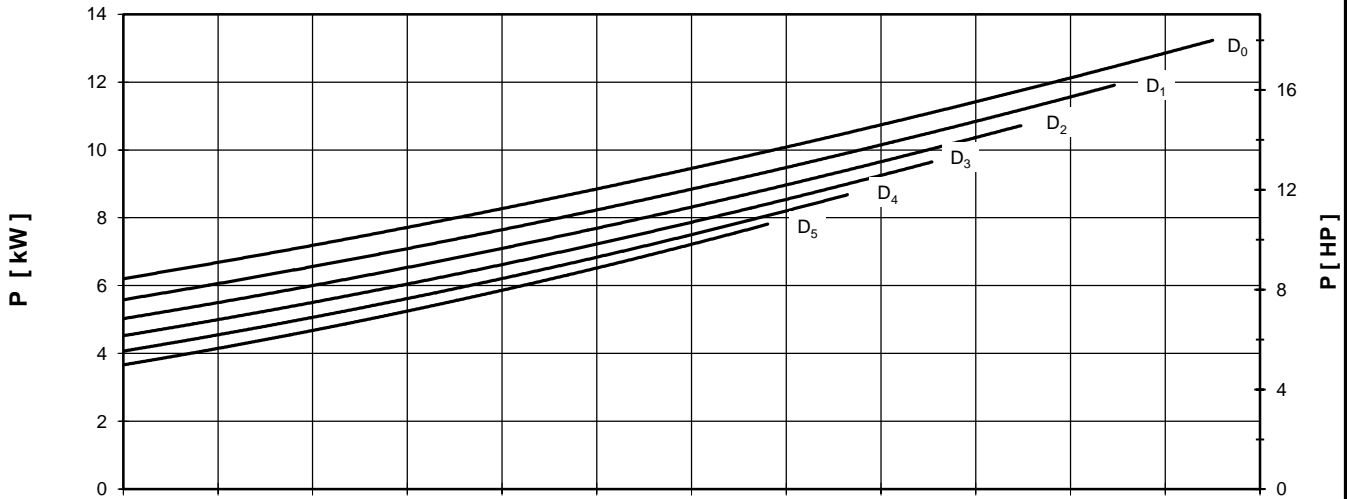
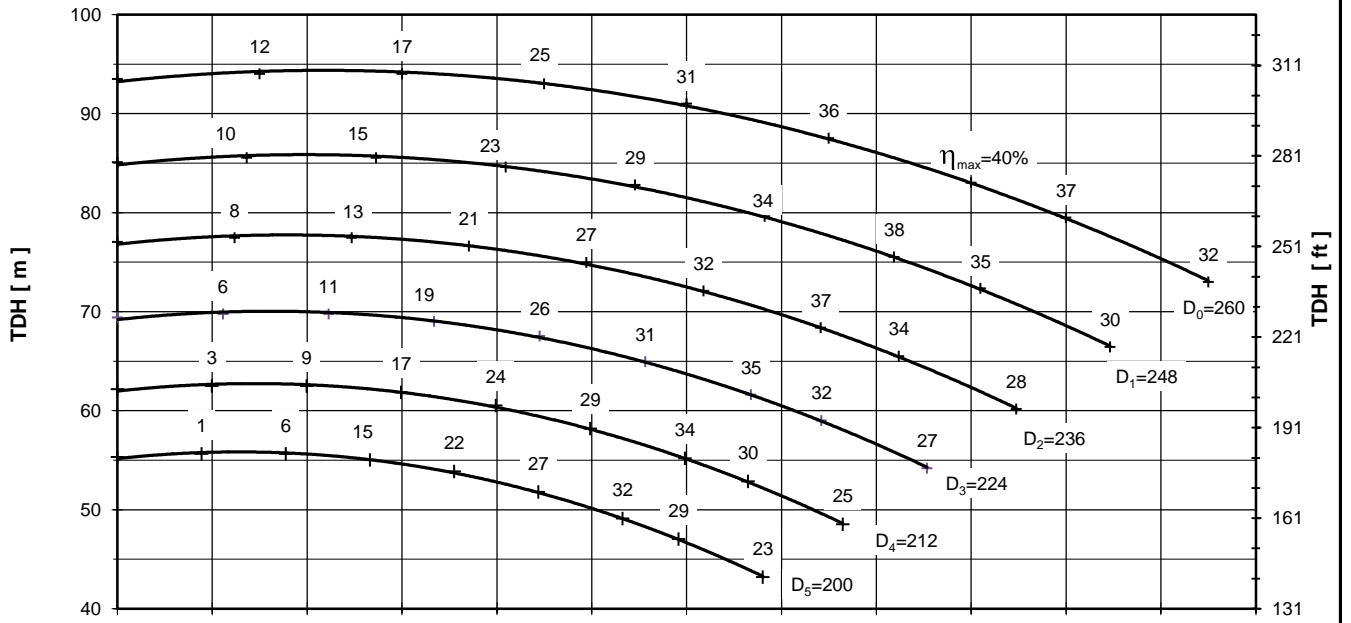

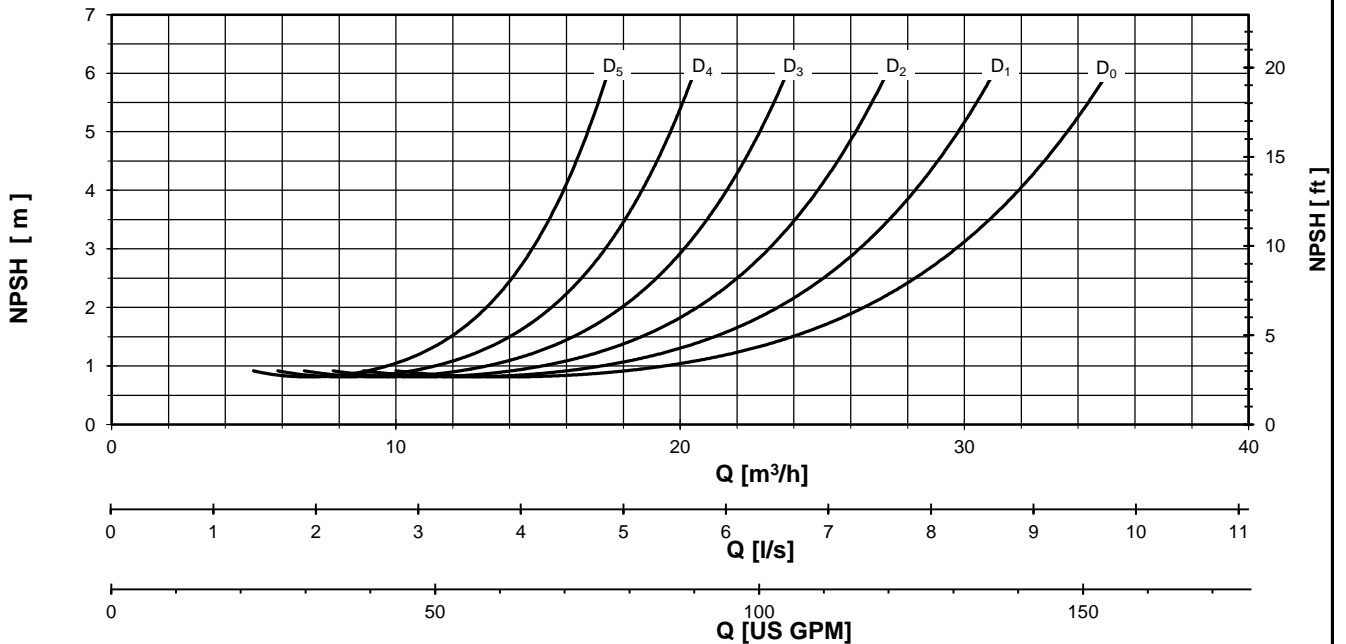
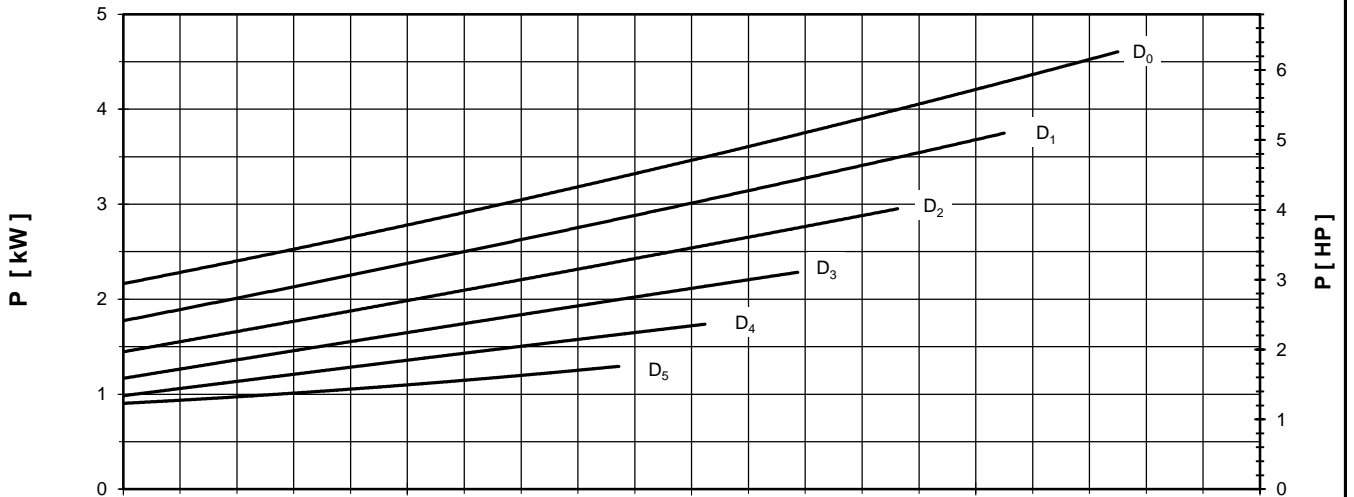
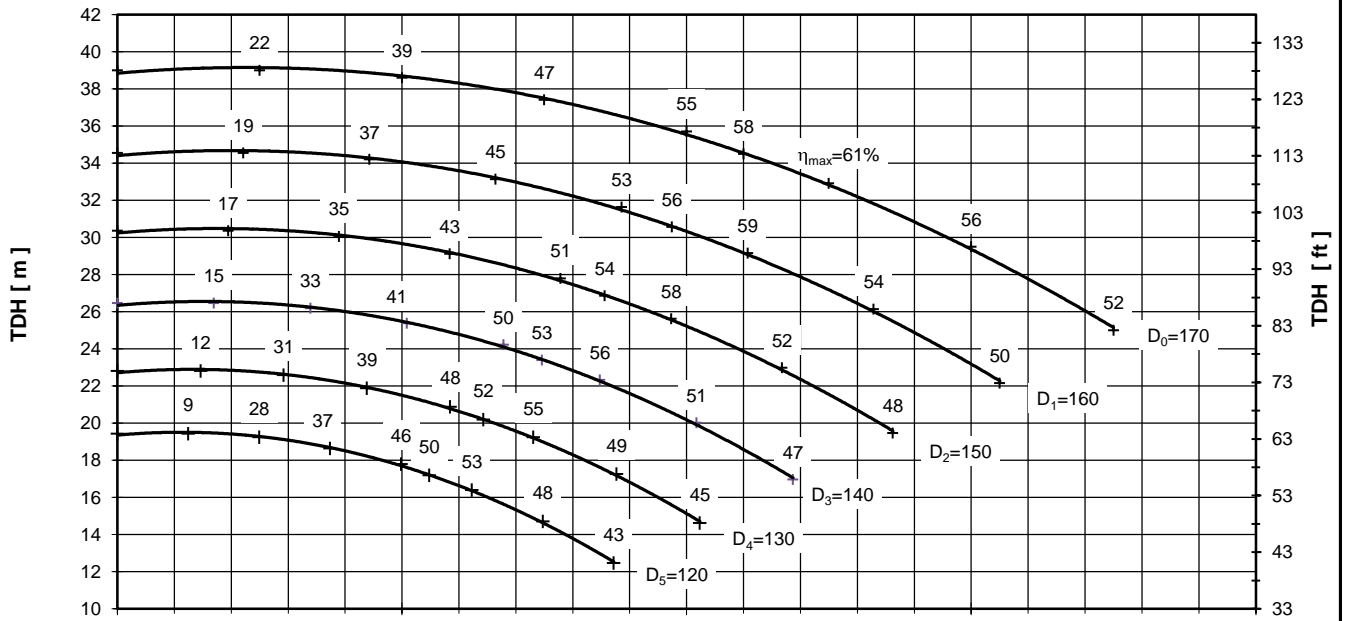

Performance curves are valid for clean cold water-kinematic viscosity 1 [mm²/s], density 1000 [kg/m³]. Methods and tolerances of presented performance curves are in accordance with ISO 9906 - Annex A



PUMP PERFORMANCE CURVES
No. 4HD.0147.05

PUMP TYPE
SCP 40 - 200
2900 [rpm]

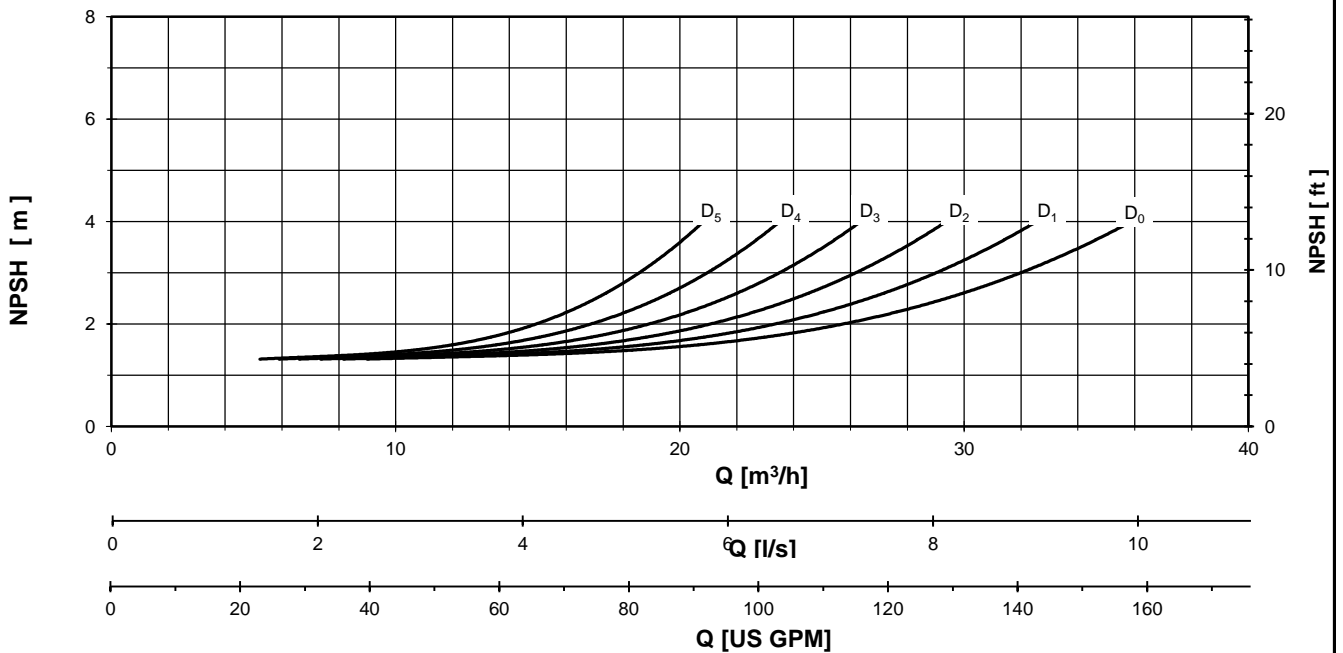
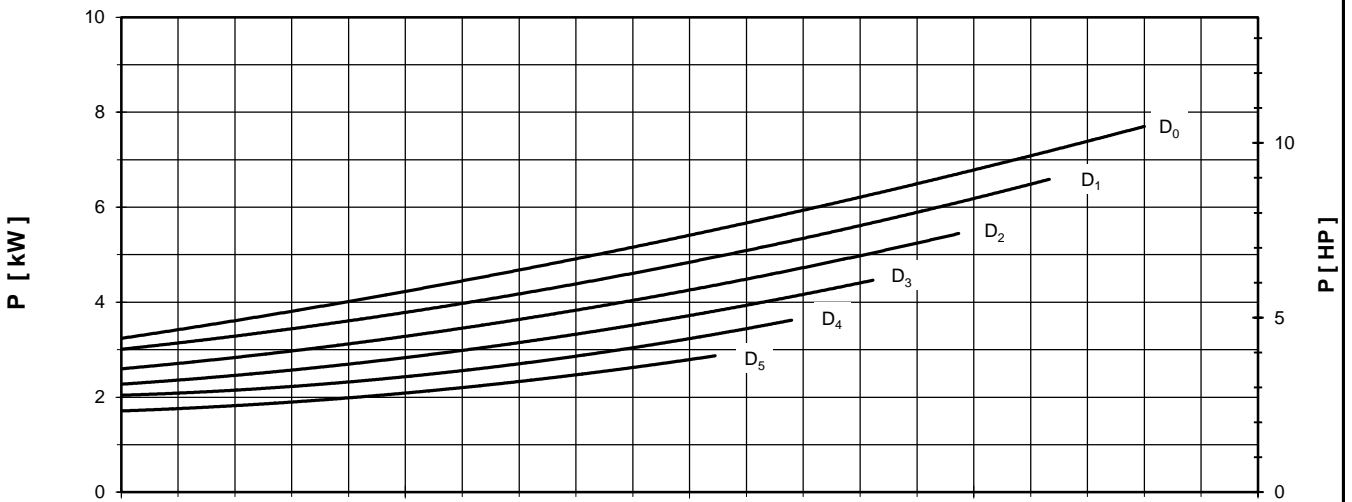
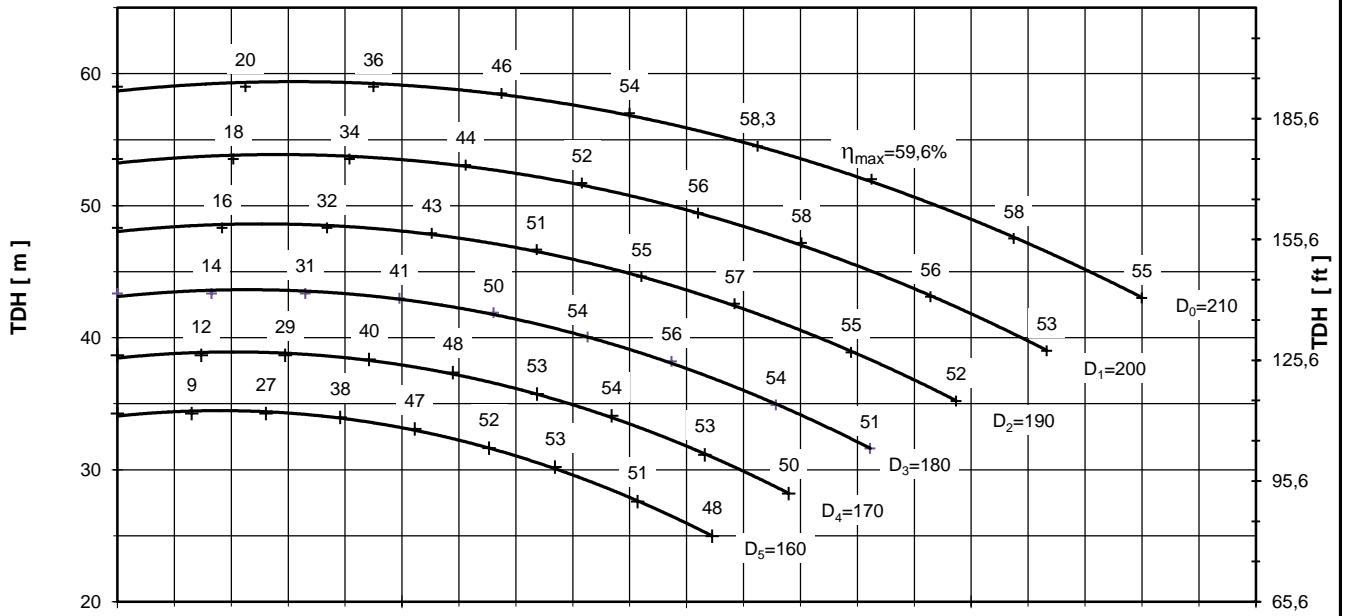

Performance curves are valid for clean cold water-kinematic viscosity 1 [mm²/s], density 1000 [kg/m³]. Methods and tolerances of presented performance curves are in accordance with ISO 9906 - Annex A

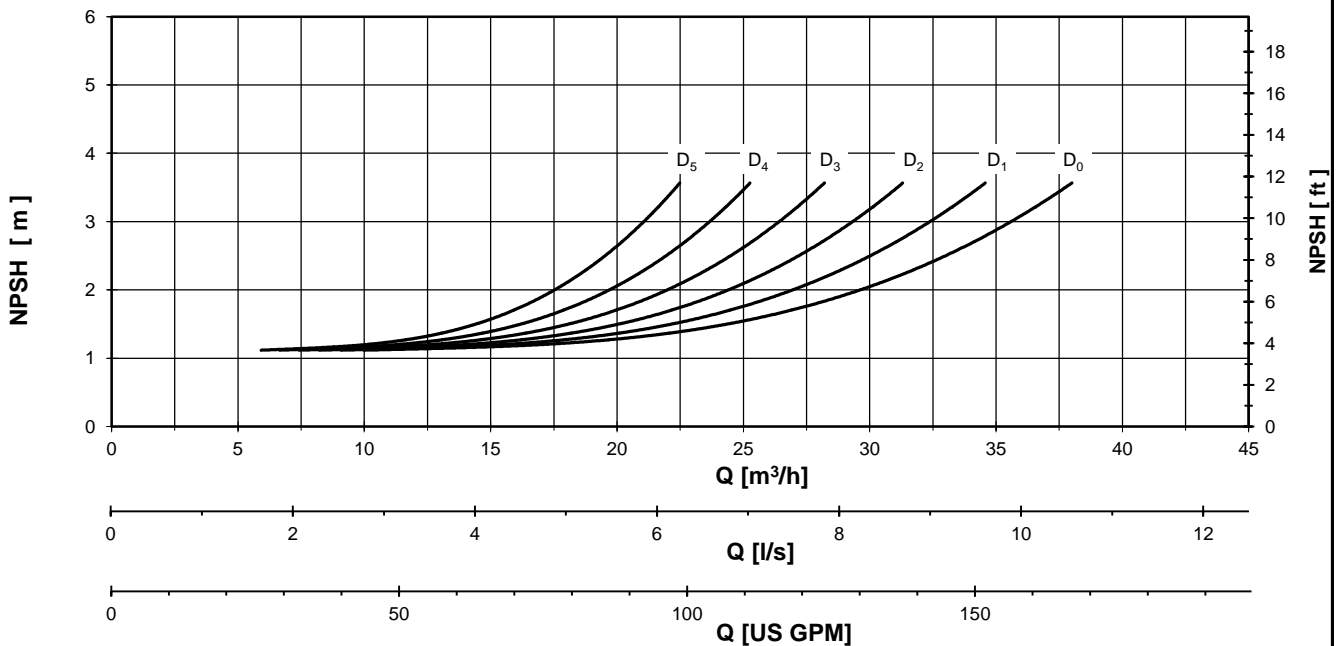
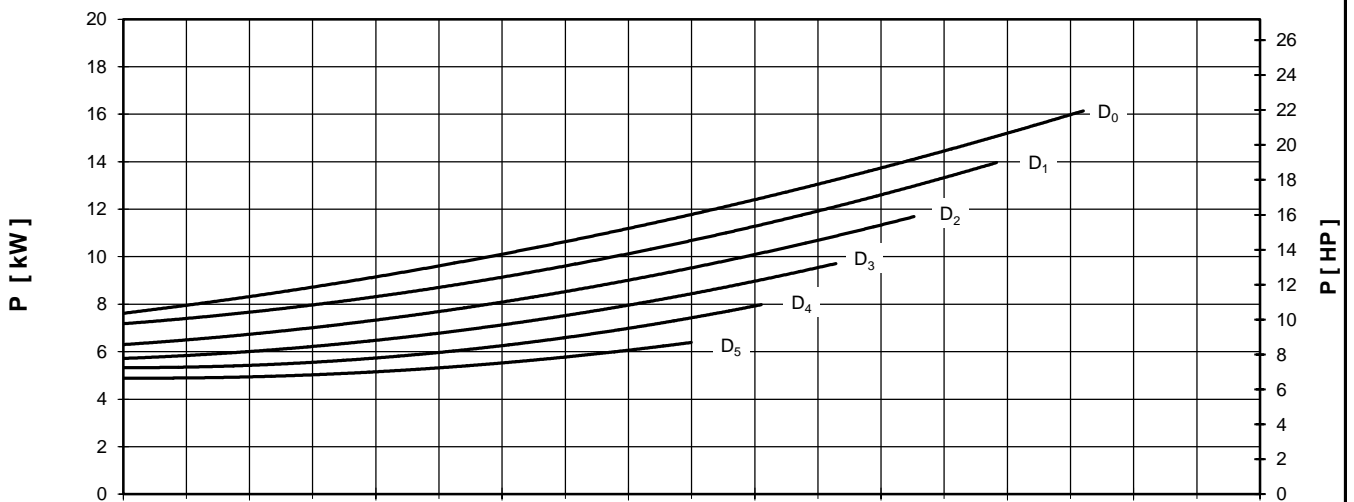
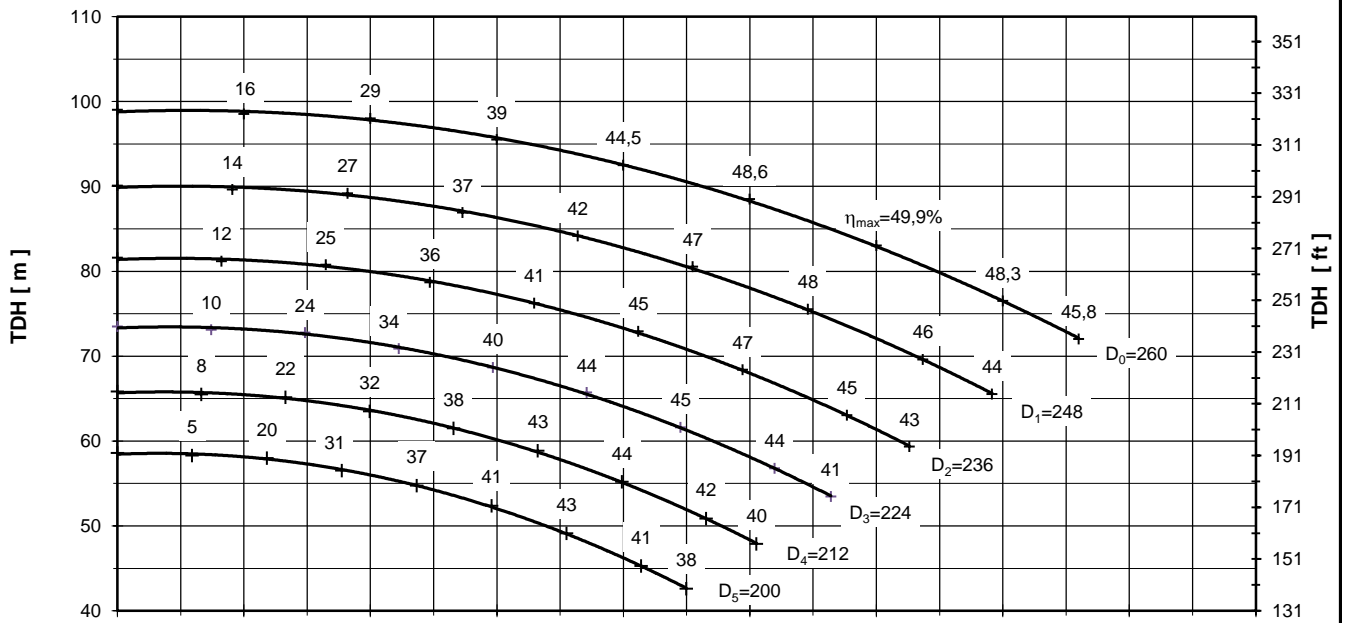

Performance curves are valid for clean cold water-kinematic viscosity 1 [mm²/s], density 1000 [kg/m³]. Methods and tolerances of presented performance curves are in accordance with ISO 9906 - Annex A



PUMP PERFORMANCE CURVES
No. 4HD.0149.05

PUMP TYPE
SCP 40 - 315
2900 [rpm]

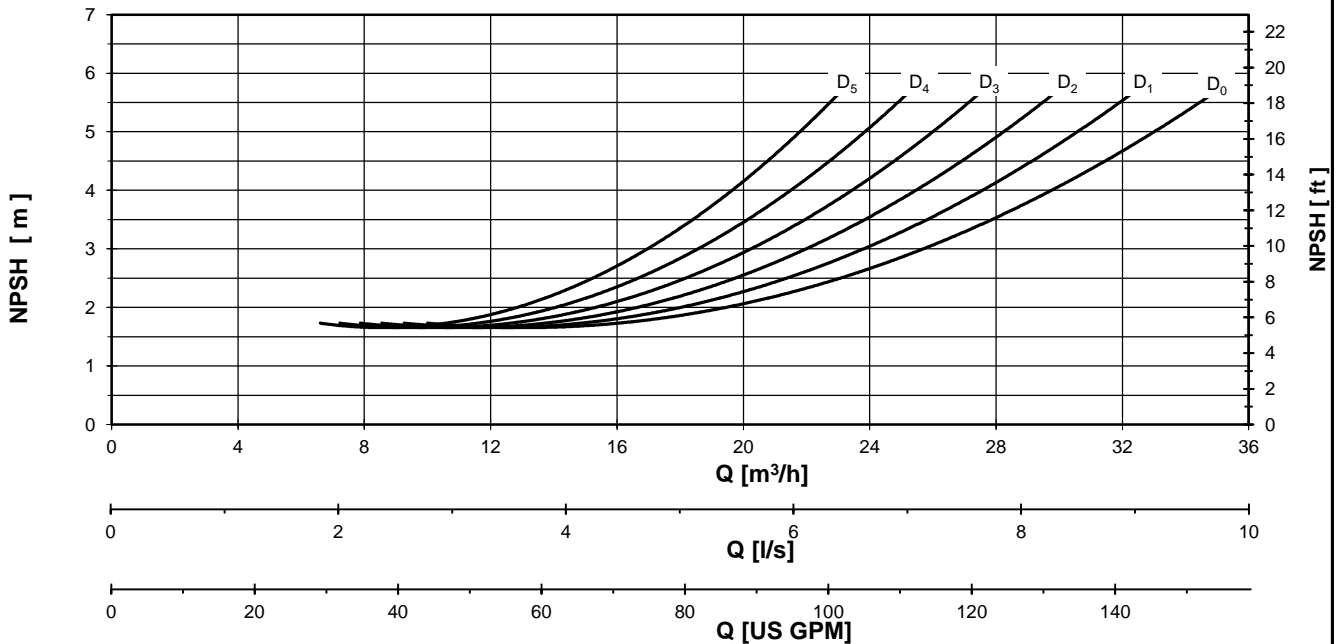
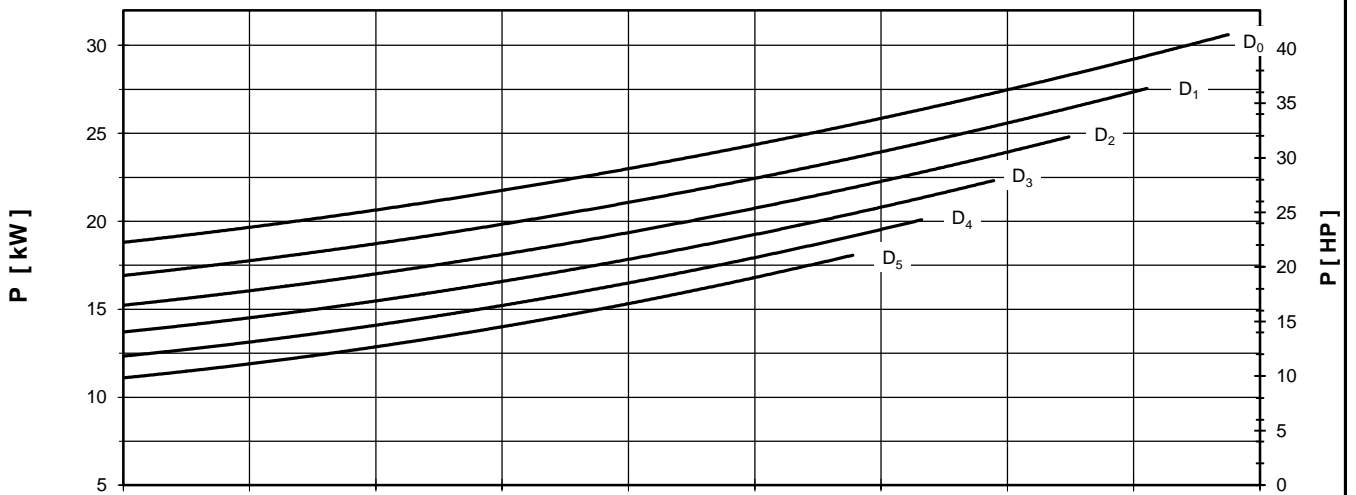
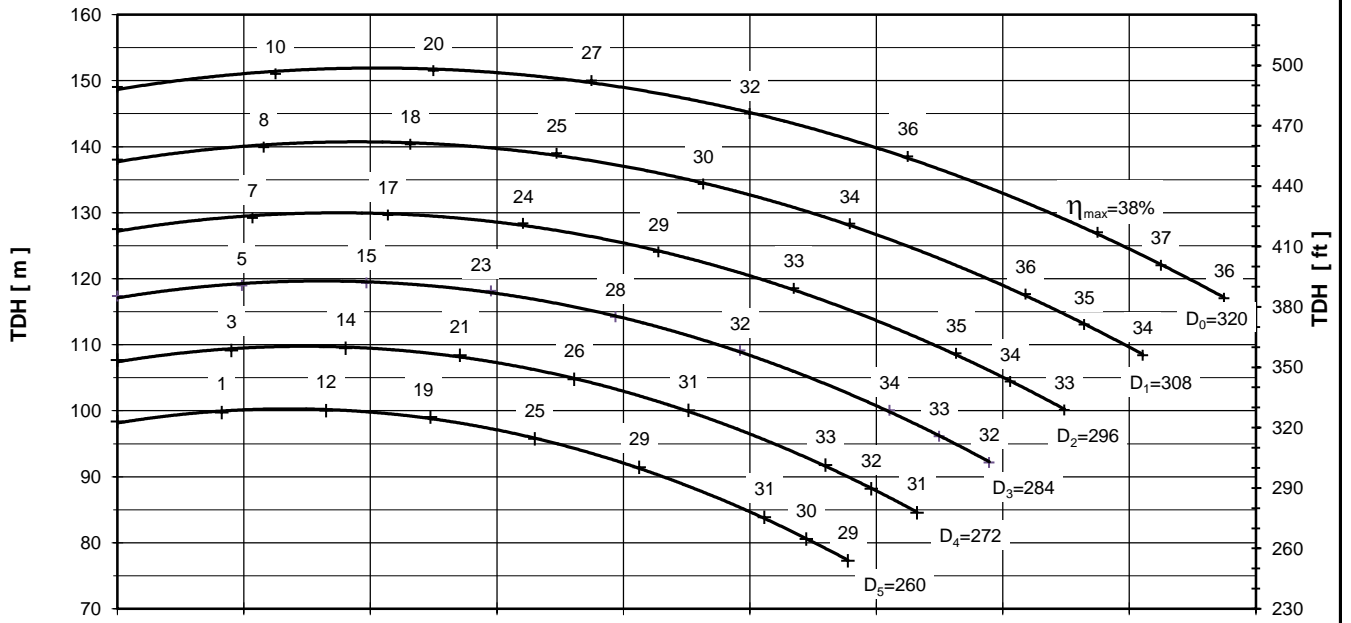

Performance curves are valid for clean cold water-kinematic viscosity 1 [mm²/s], density 1000 [kg/m³]. Methods and tolerances of presented performance curves are in accordance with ISO 9906 - Annex A

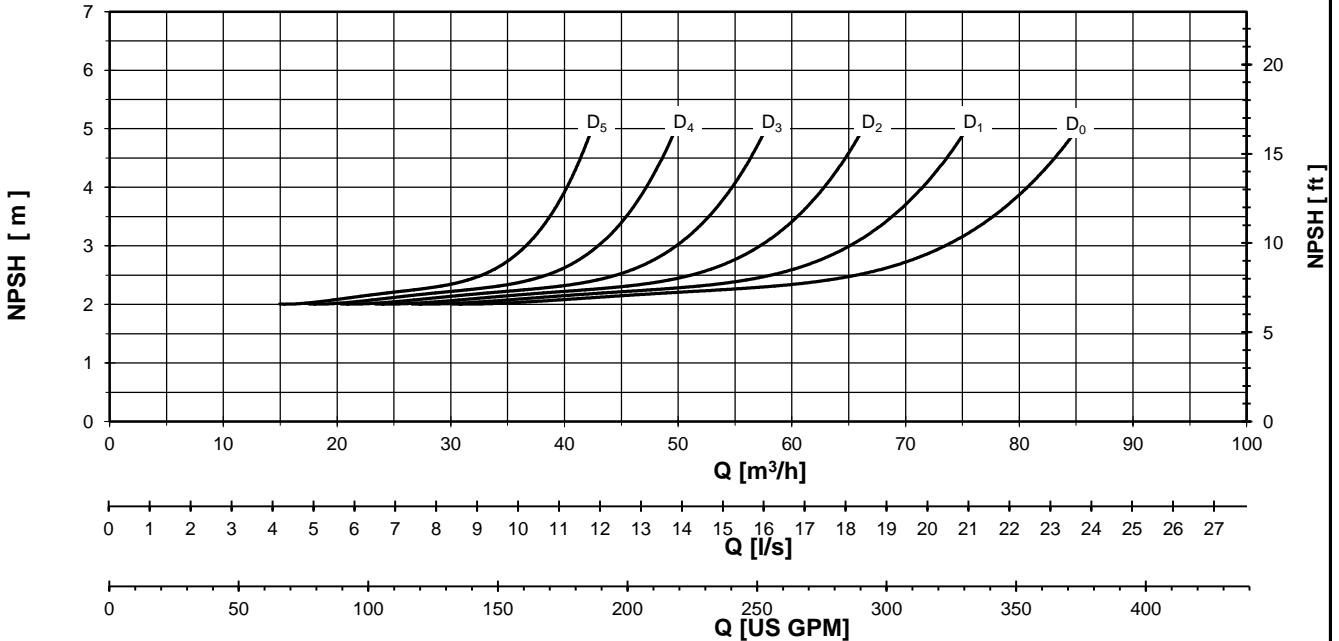
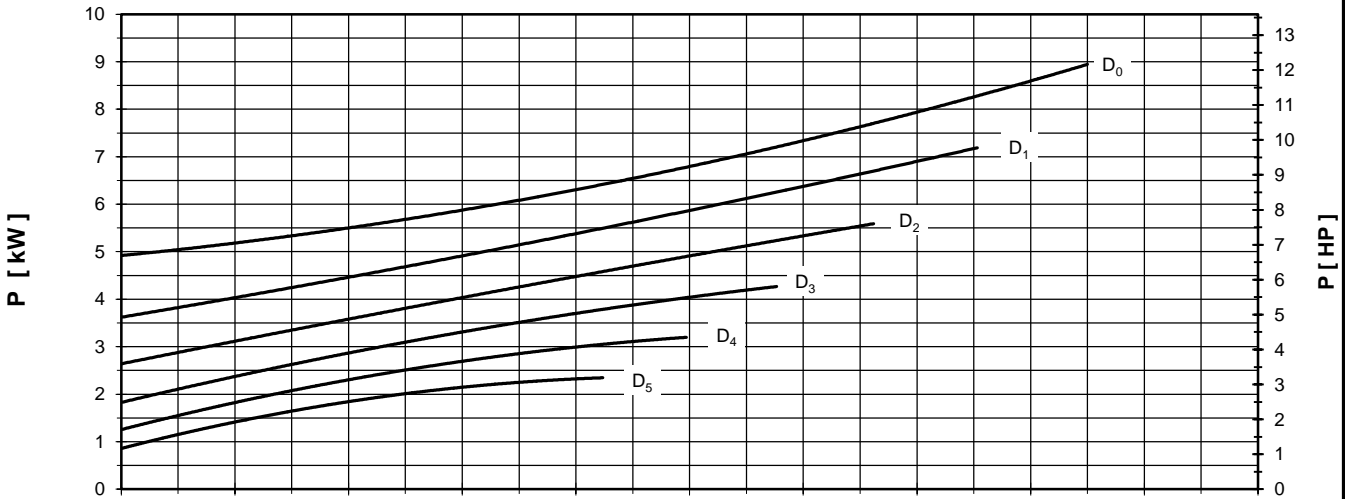
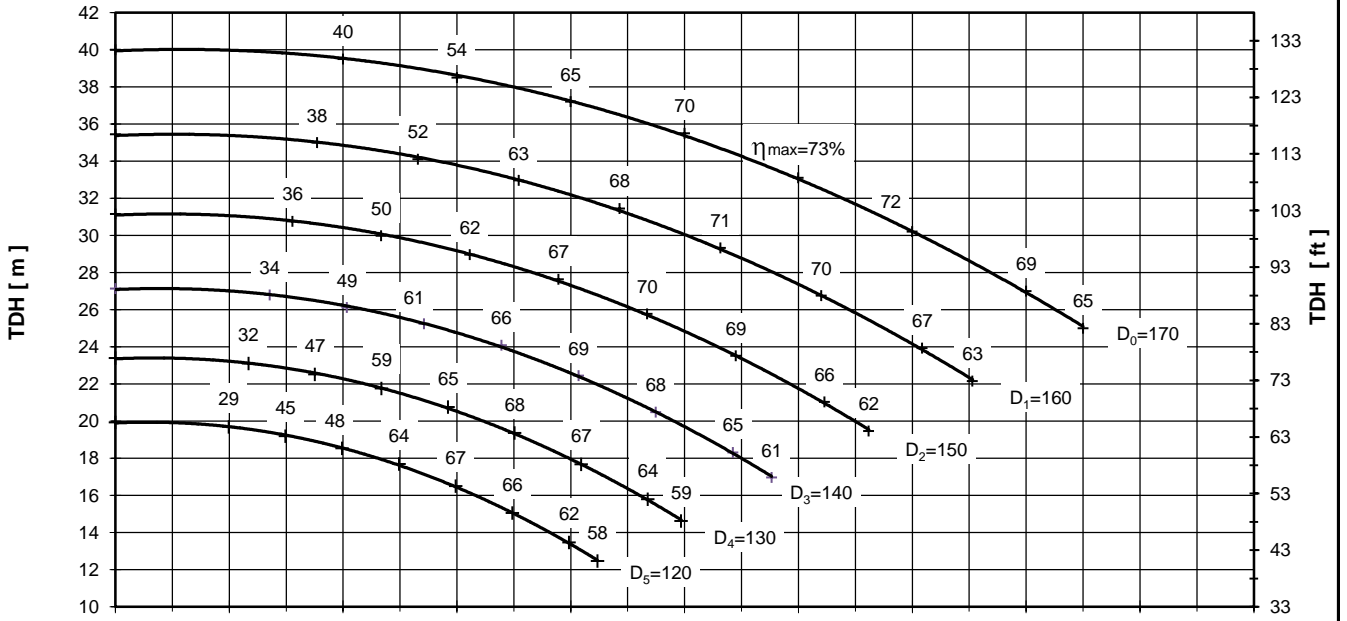

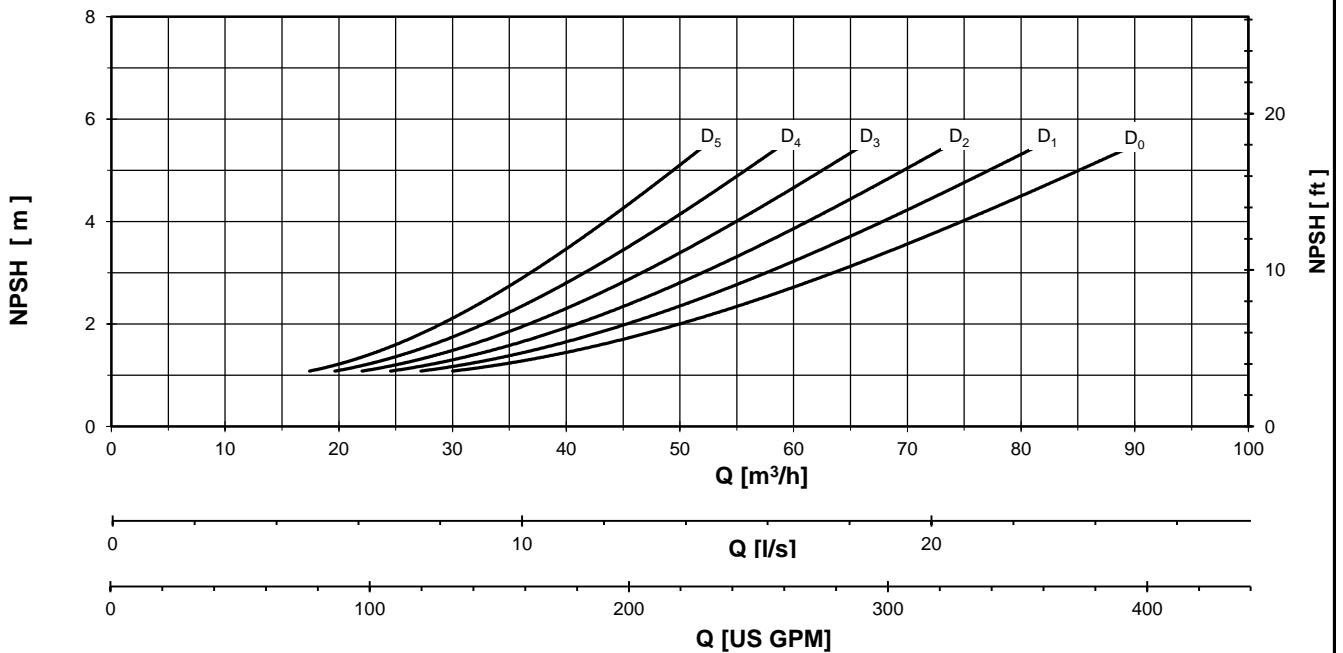
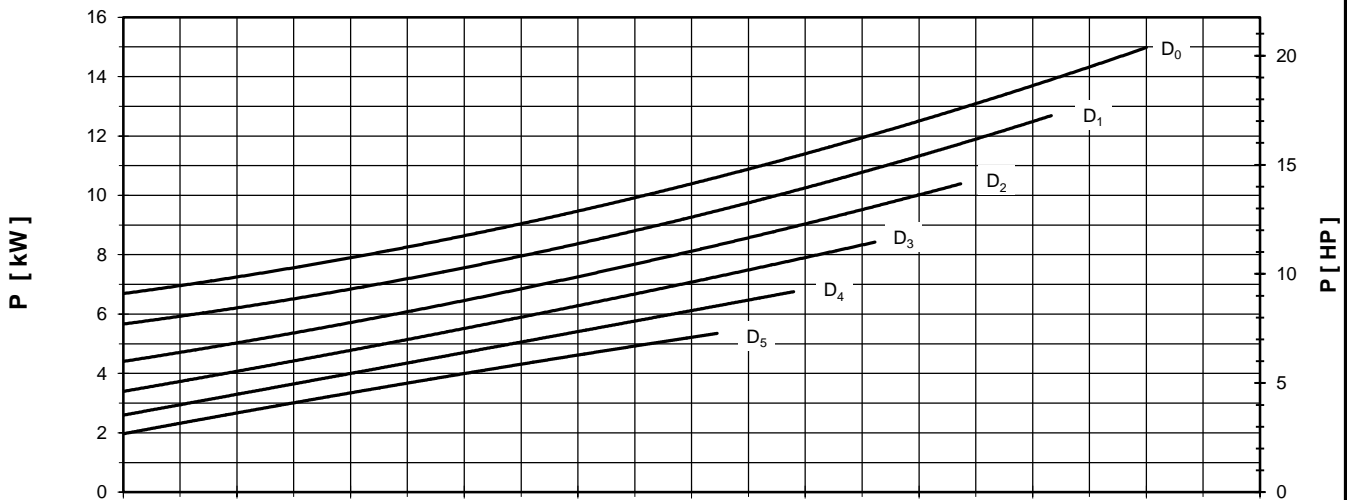
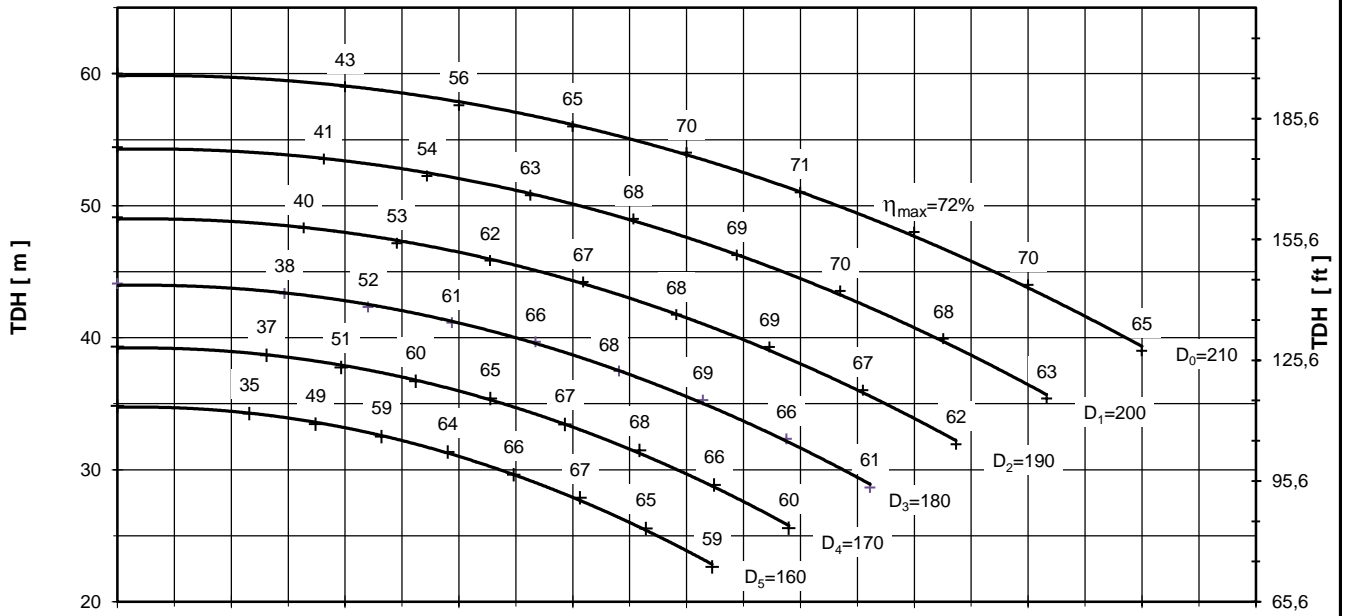

Performance curves are valid for clean cold water-kinematic viscosity 1 [mm²/s], density 1000 [kg/m³]. Methods and tolerances of presented performance curves are in accordance with ISO 9906 - Annex A



PUMP PERFORMANCE CURVES
No. 4HS.0153.05

PUMP TYPE
SCP 50 - 250
2900 [rpm]

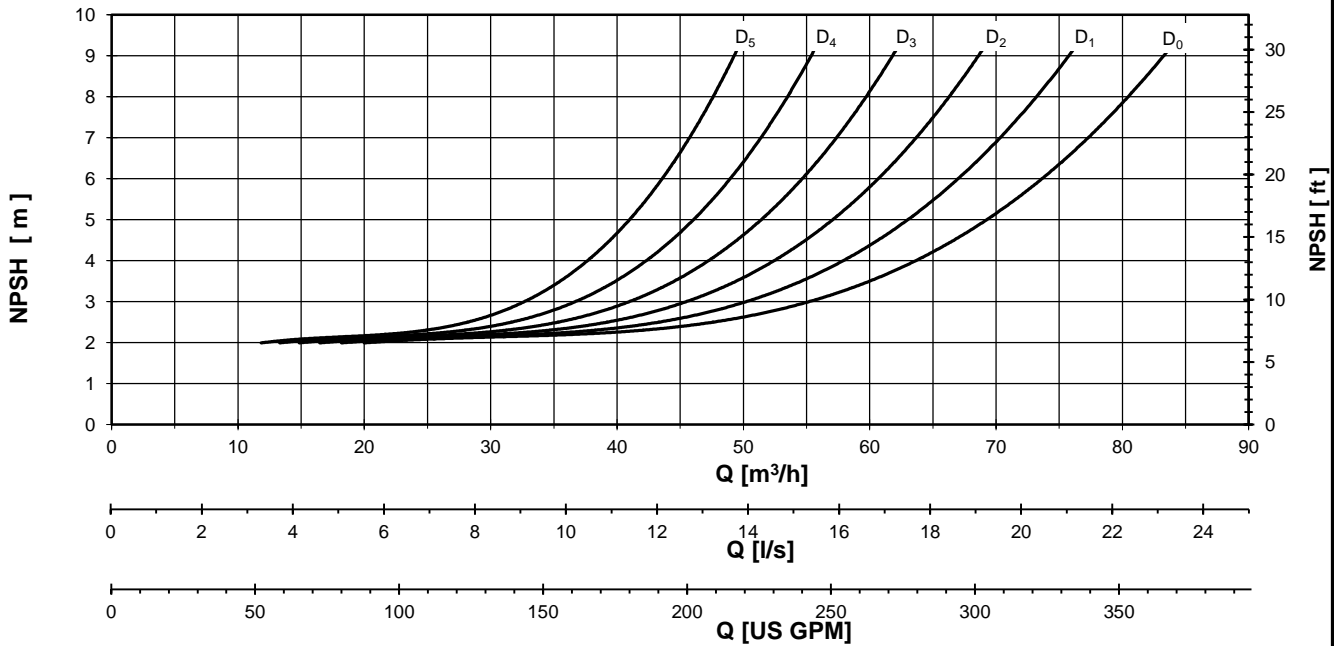
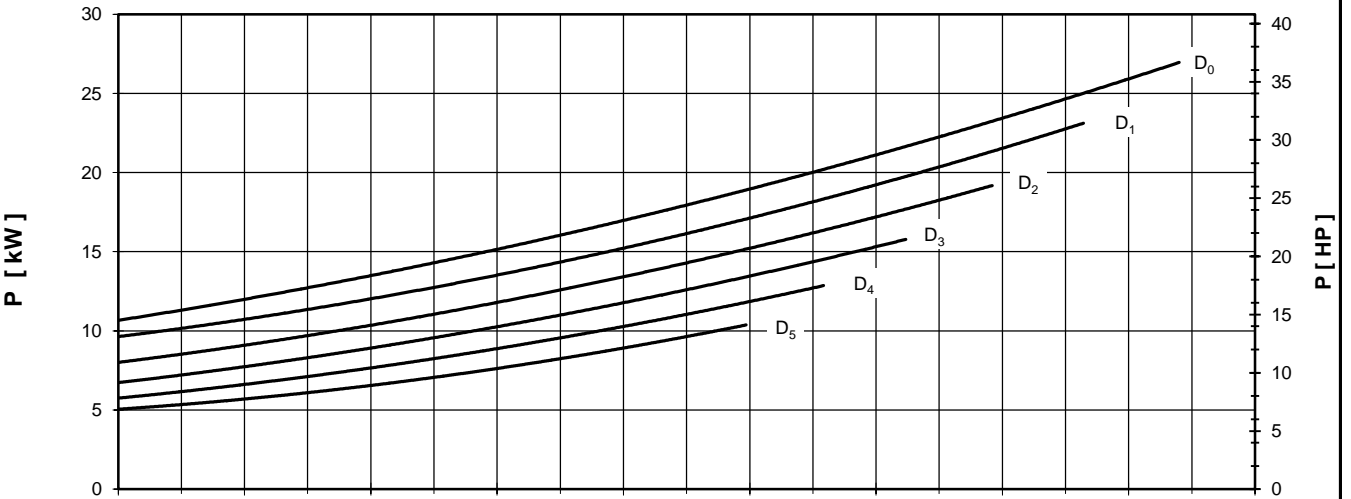
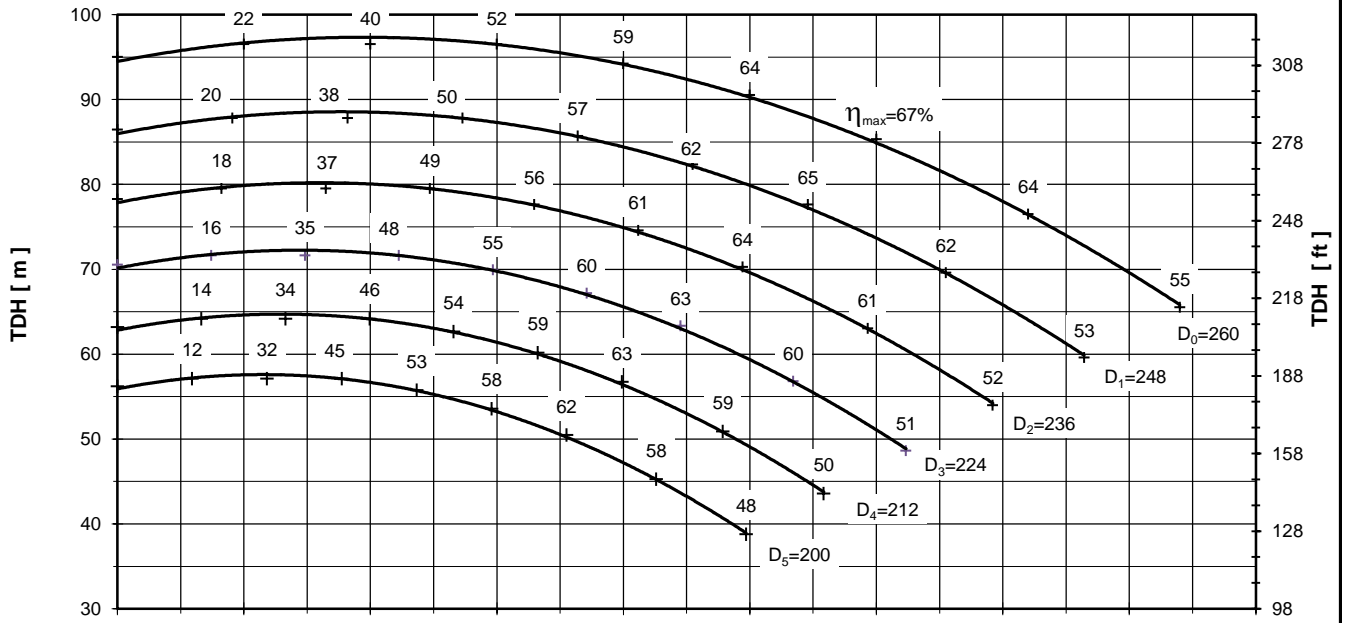

Performance curves are valid for clean cold water-kinematic viscosity 1 [mm²/s], density 1000 [kg/m³]. Methods and tolerances of presented performance curves are in accordance with ISO 9906 - Annex A



PUMP PERFORMANCE CURVES
No. 4HD.0154.05

PUMP TYPE
SCP 50 - 315
2900 [rpm]

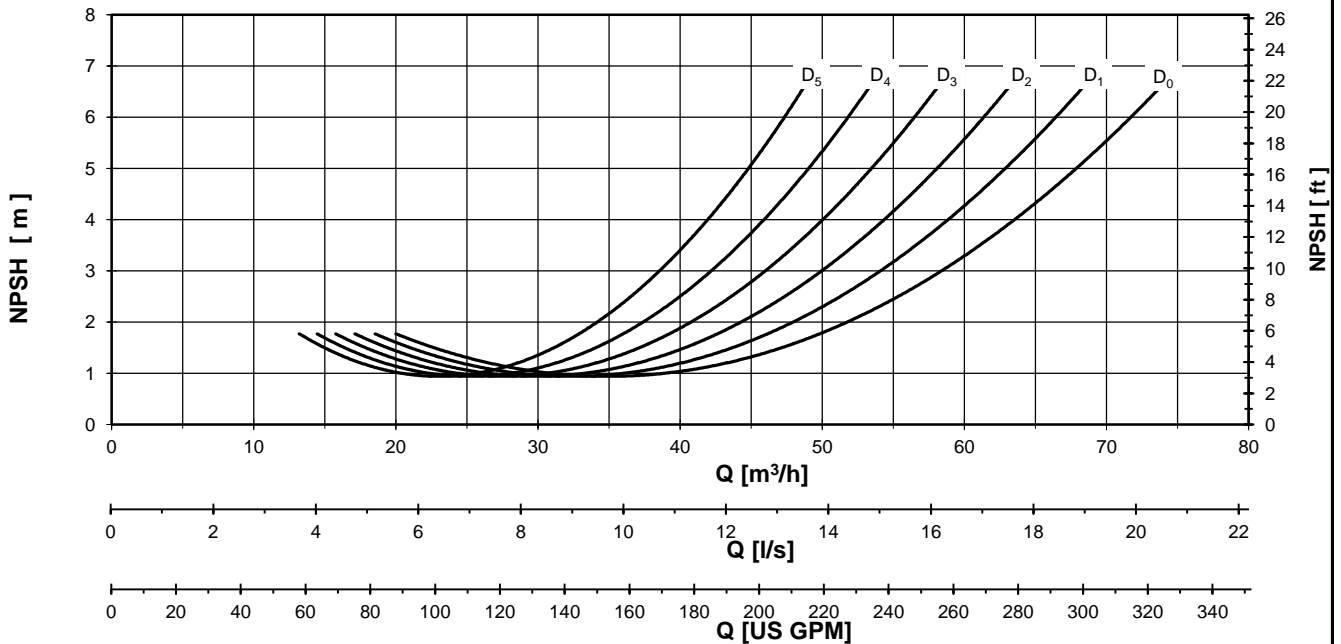
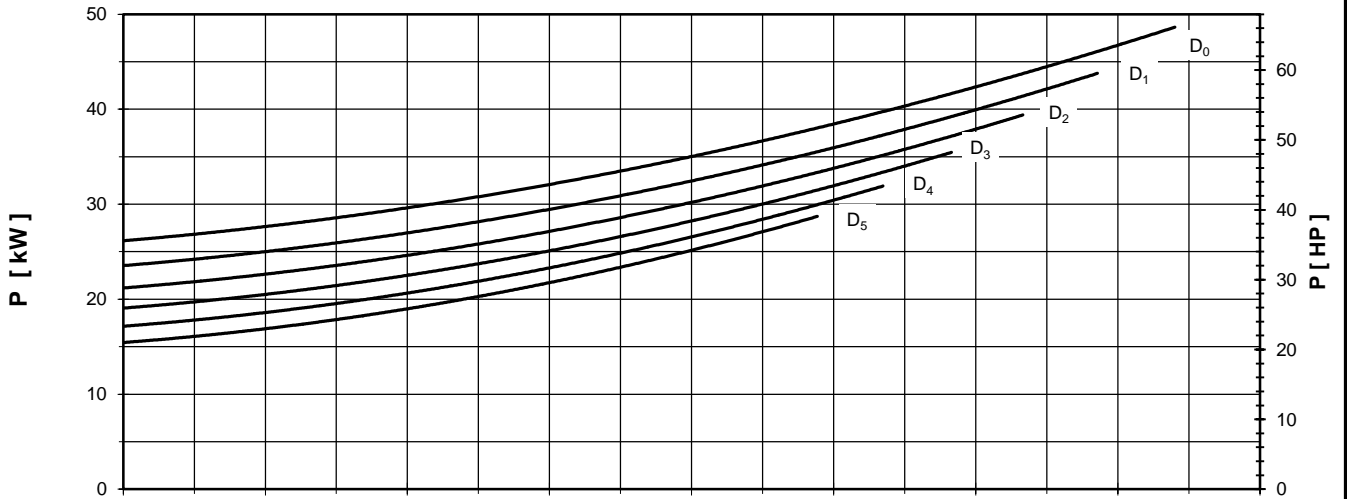
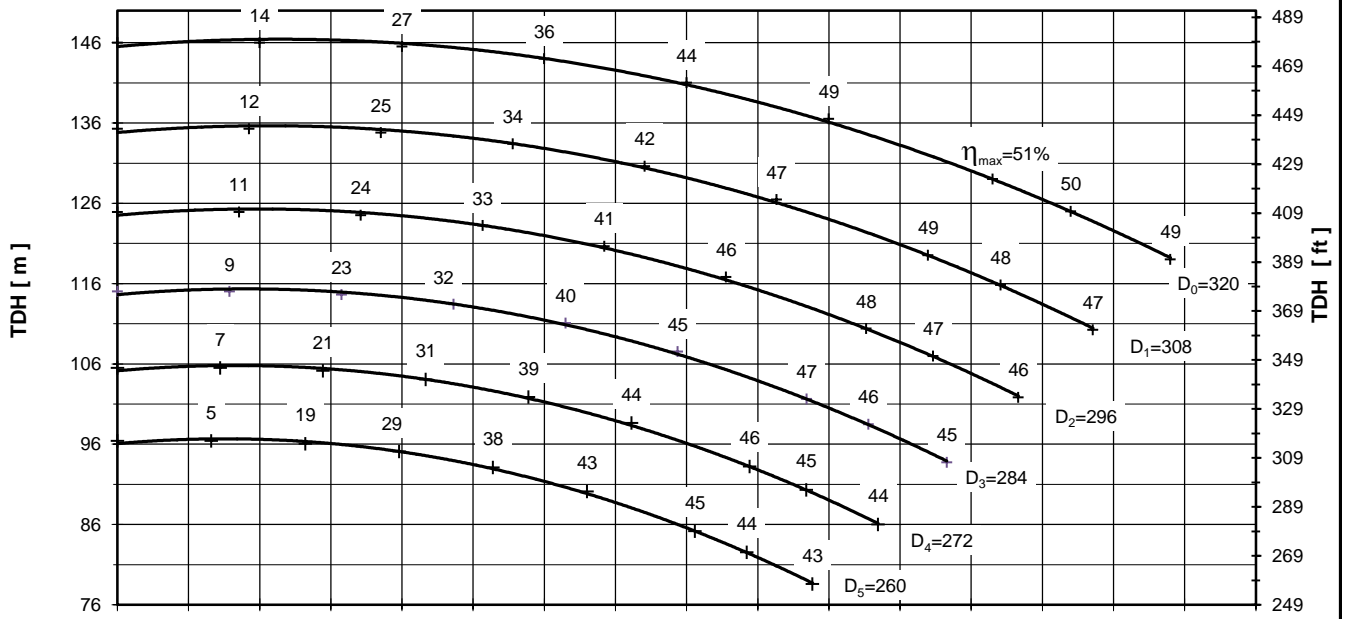

Performance curves are valid for clean cold water-kinematic viscosity 1 [mm²/s], density 1000 [kg/m³]. Methods and tolerances of presented performance curves are in accordance with ISO 9906 - Annex A

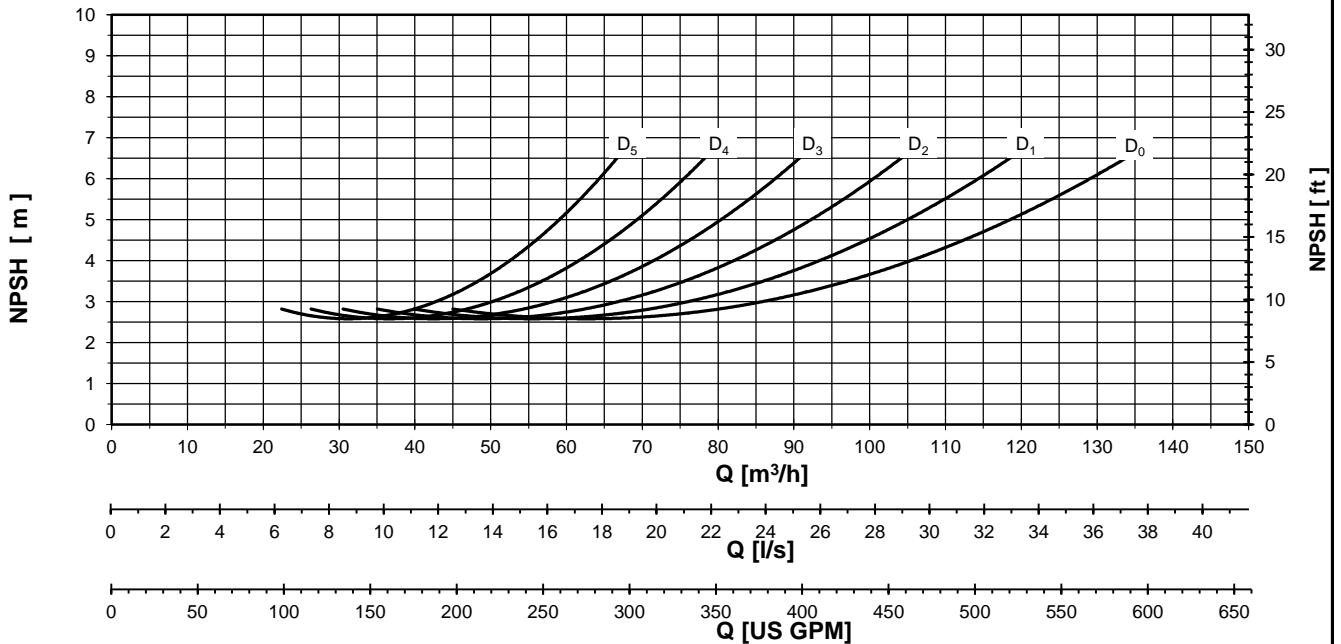
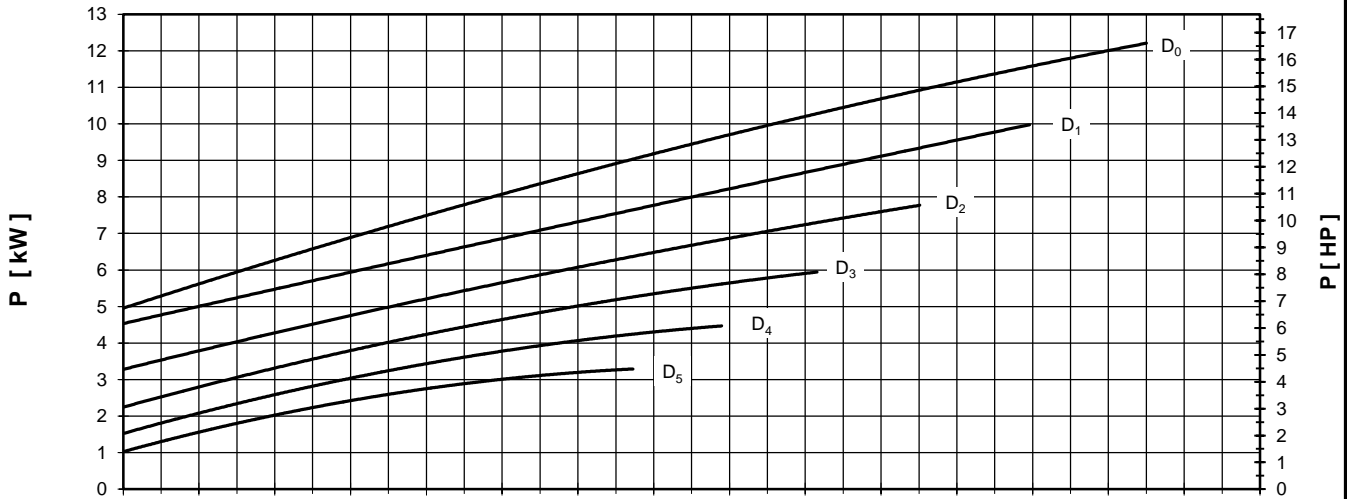
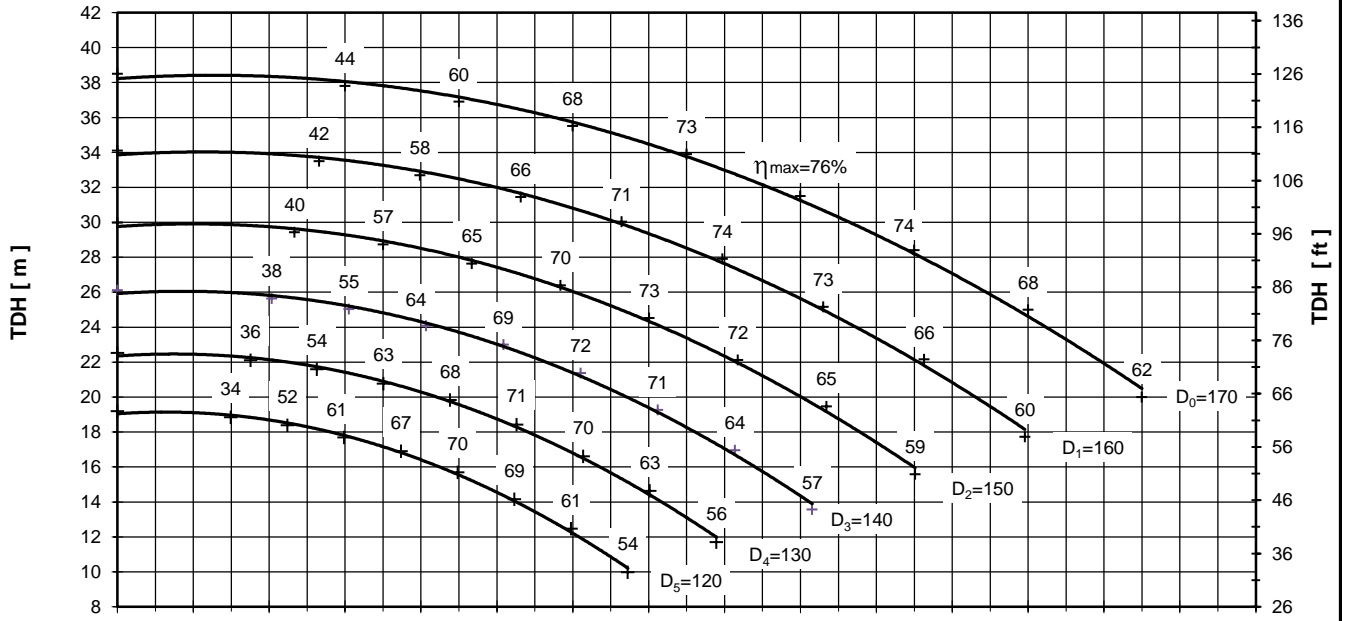

Performance curves are valid for clean cold water-kinematic viscosity 1 [mm²/s], density 1000 [kg/m³]. Methods and tolerances of presented performance curves are in accordance with ISO 9906 - Annex A

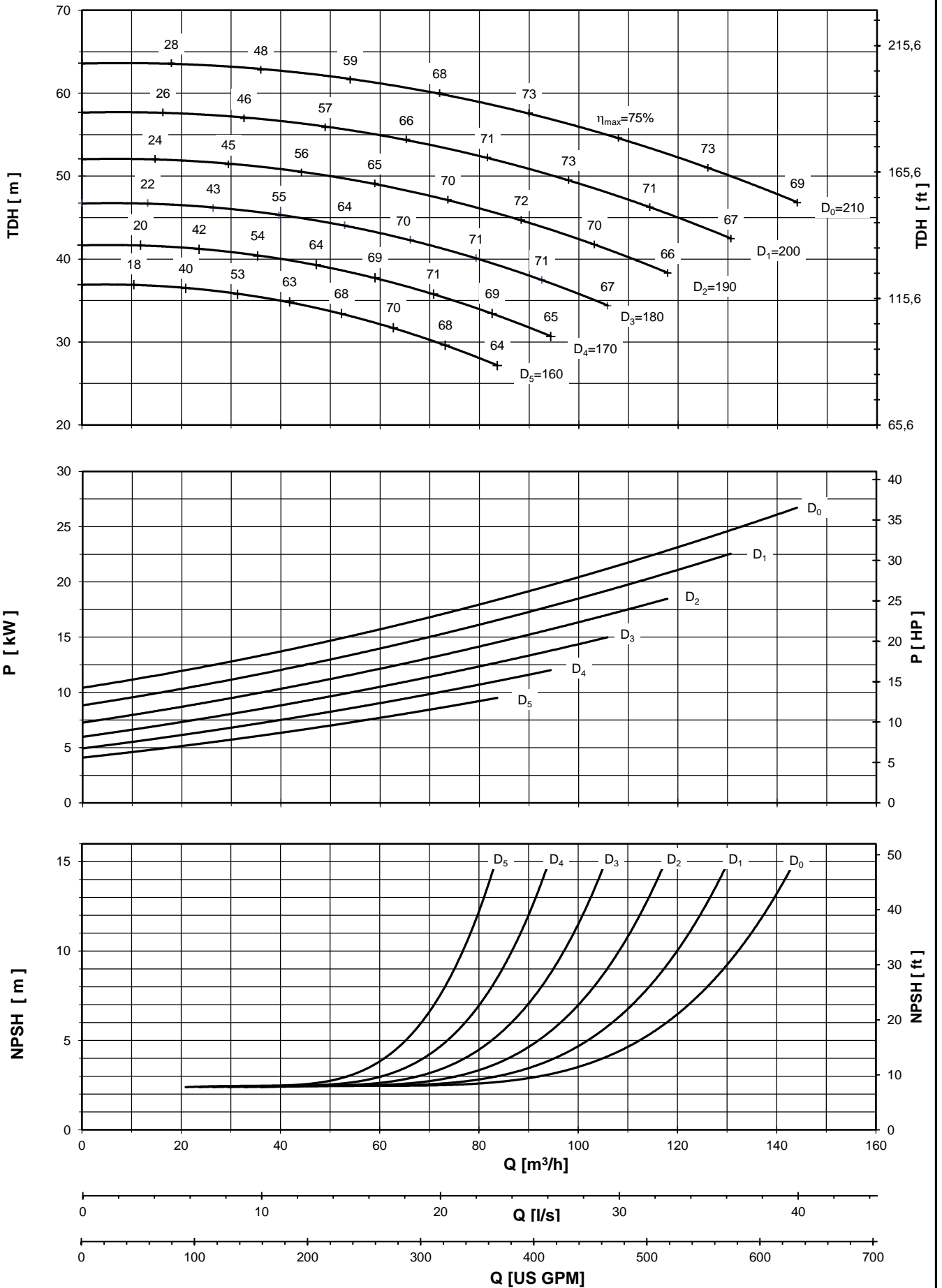

Performance curves are valid for clean cold water-kinematic viscosity 1 [mm²/s], density 1000 [kg/m³]. Methods and tolerances of presented performance curves are in accordance with ISO 9906 - Annex A

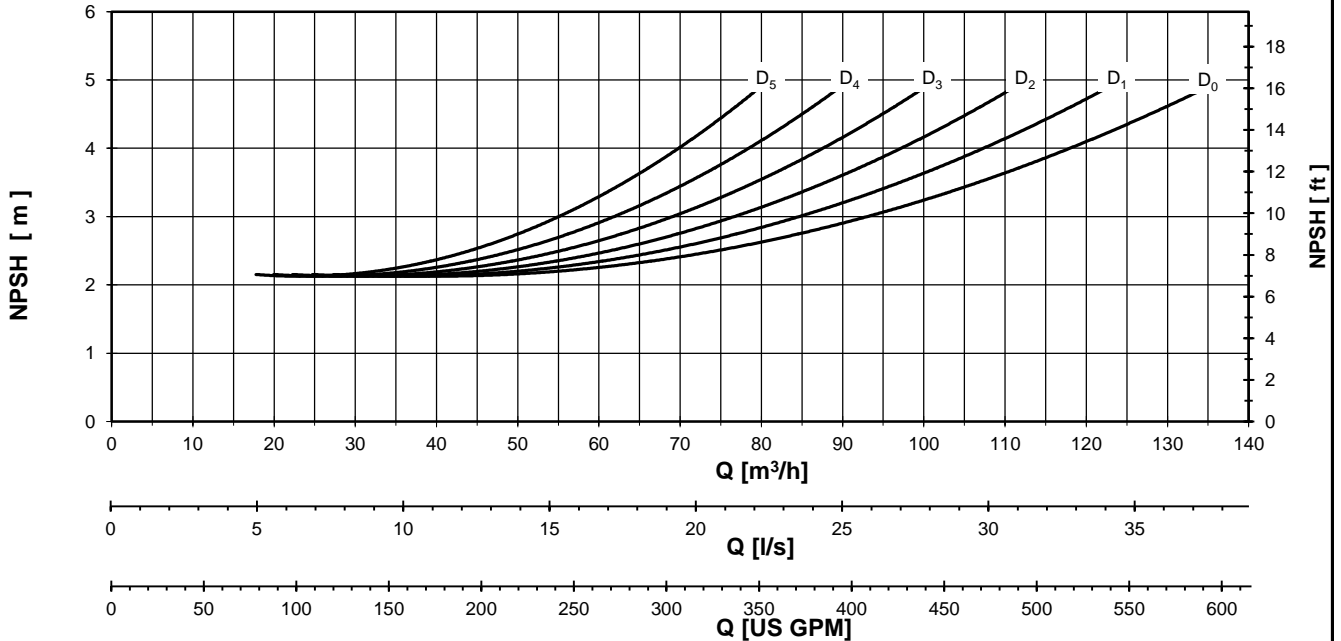
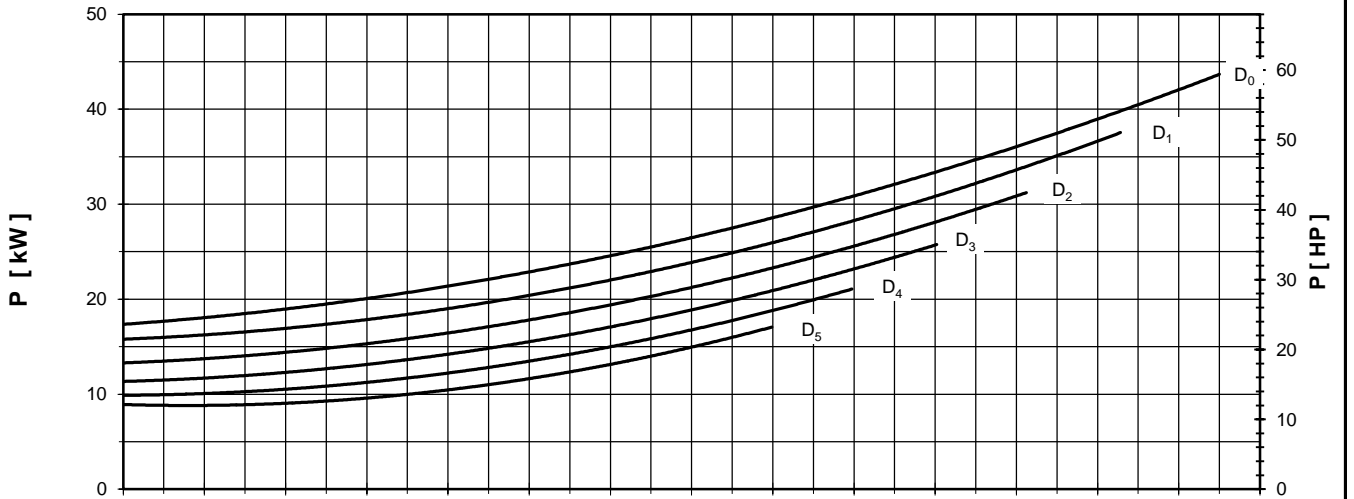
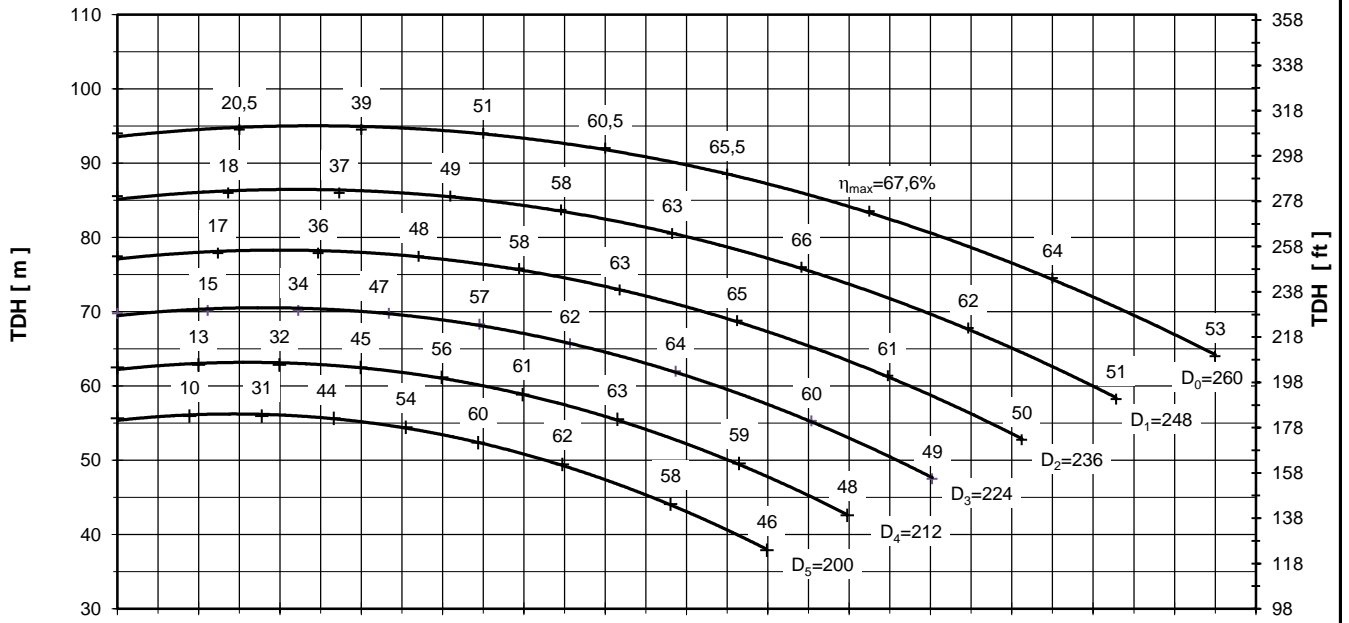

Performance curves are valid for clean cold water-kinematic viscosity 1 [mm²/s], density 1000 [kg/m³]. Methods and tolerances of presented performance curves are in accordance with ISO 9906 - Annex A

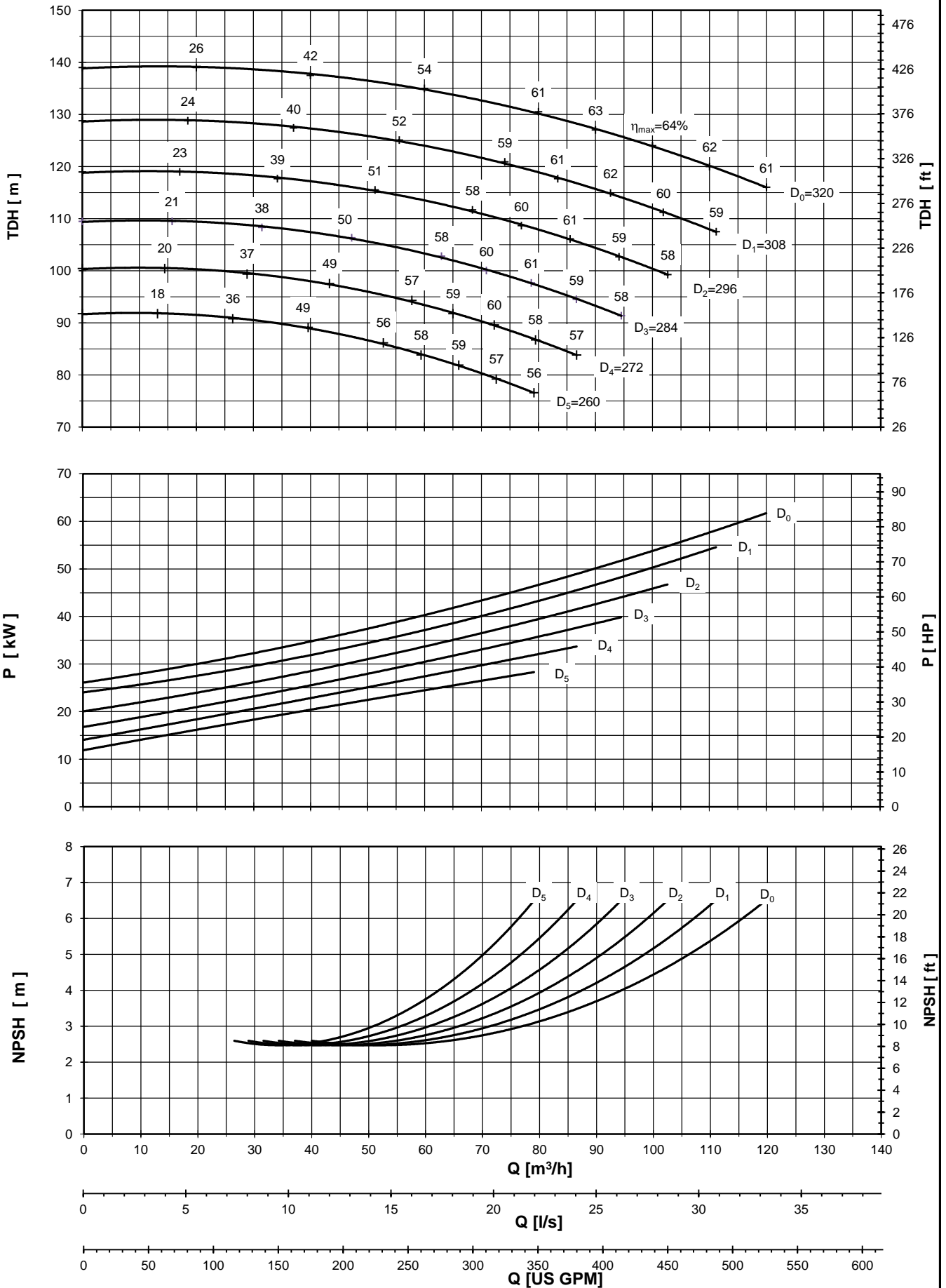

Performance curves are valid for clean cold water-kinematic viscosity 1 [mm²/s], density 1000 [kg/m³]. Methods and tolerances of presented performance curves are in accordance with ISO 9906 - Annex A

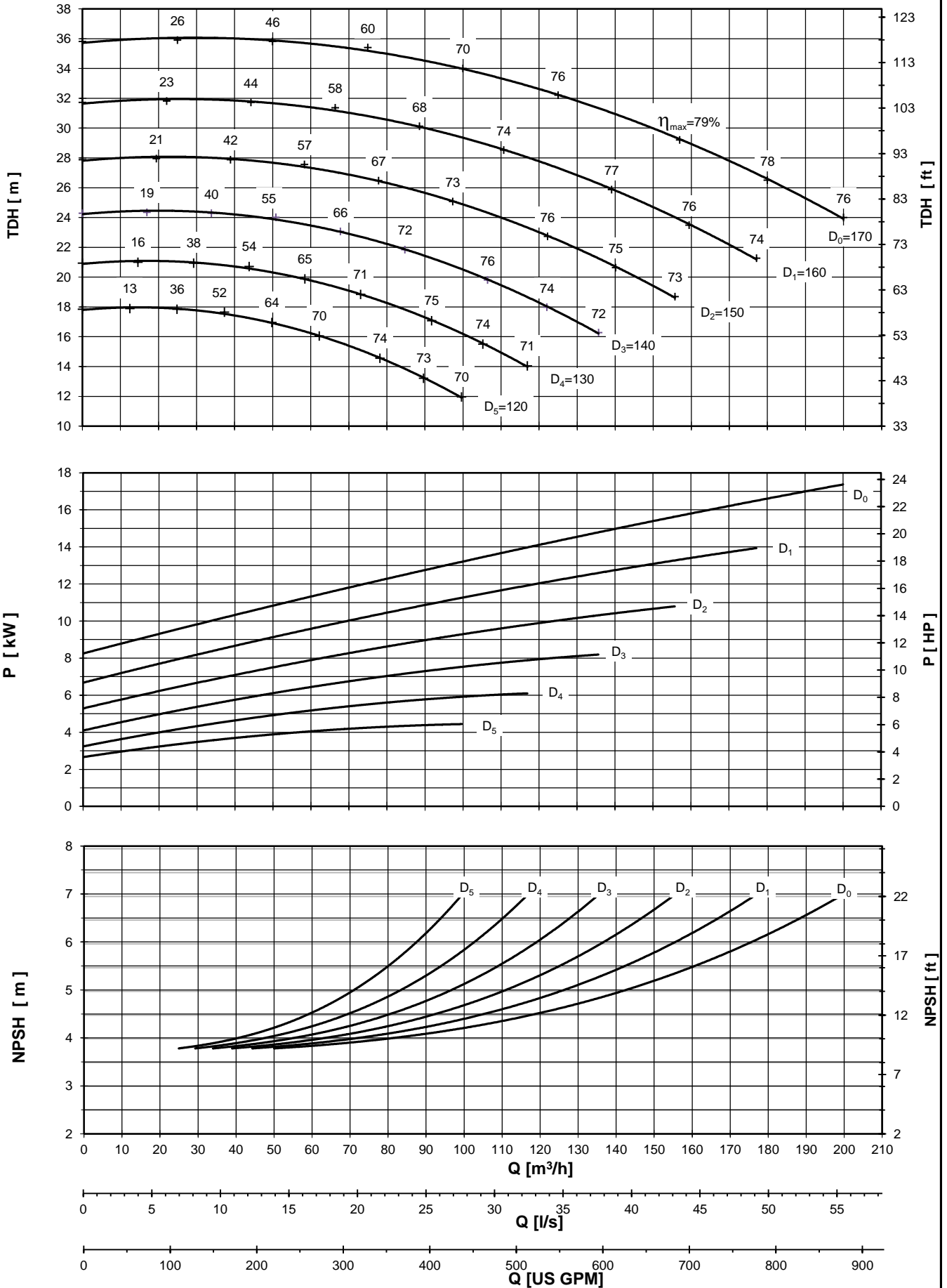

Performance curves are valid for clean cold water-kinematic viscosity 1 [mm²/s], density 1000 [kg/m³]. Methods and tolerances of presented performance curves are in accordance with ISO 9906 - Annex A

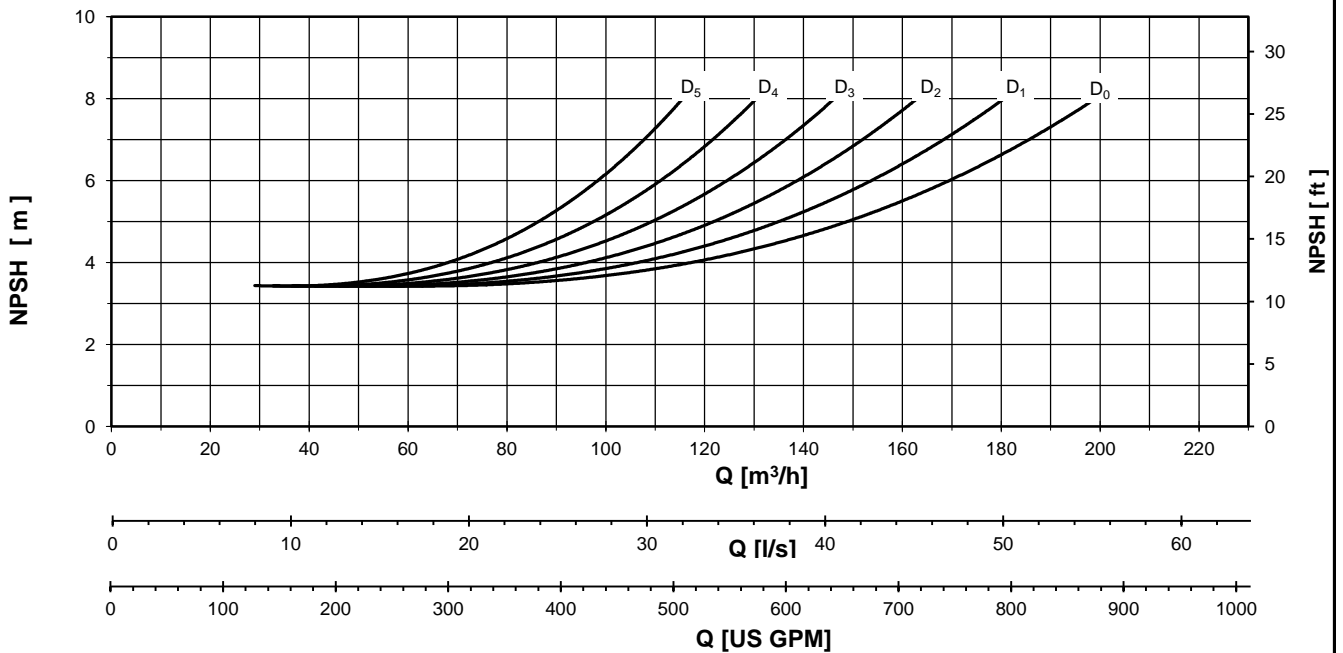
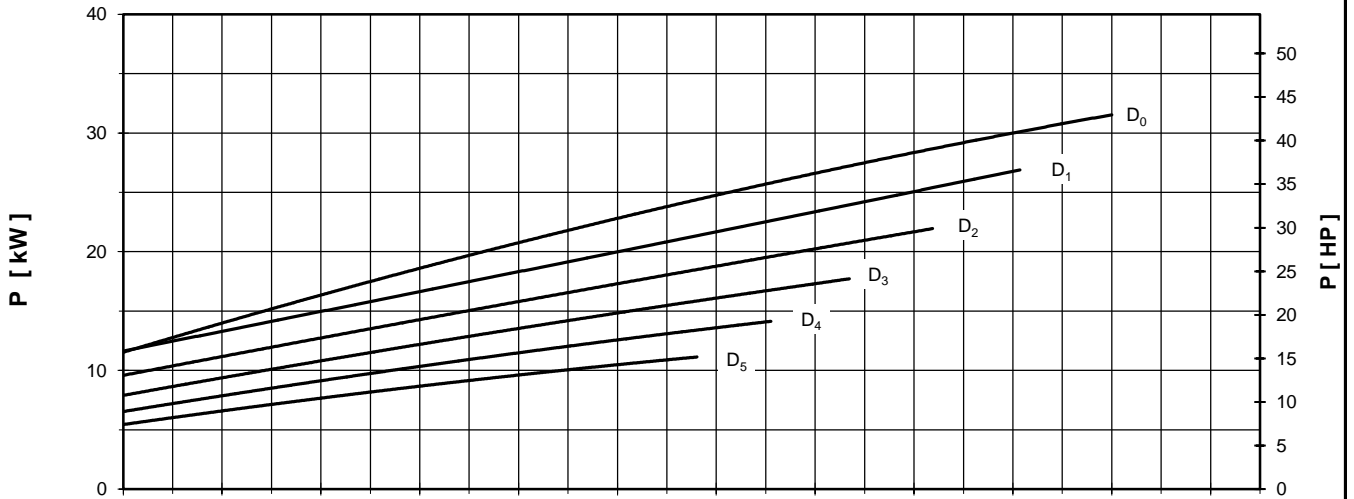
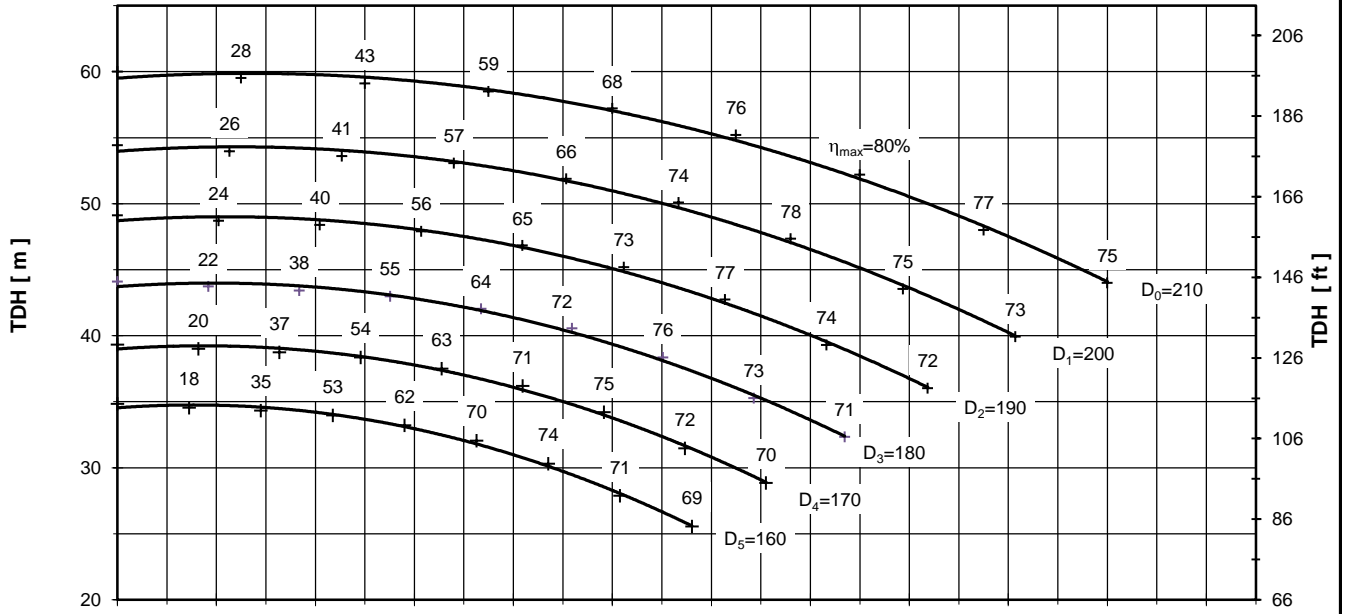

Performance curves are valid for clean cold water-kinematic viscosity 1 [mm²/s], density 1000 [kg/m³]. Methods and tolerances of presented performance curves are in accordance with ISO 9906 - Annex A

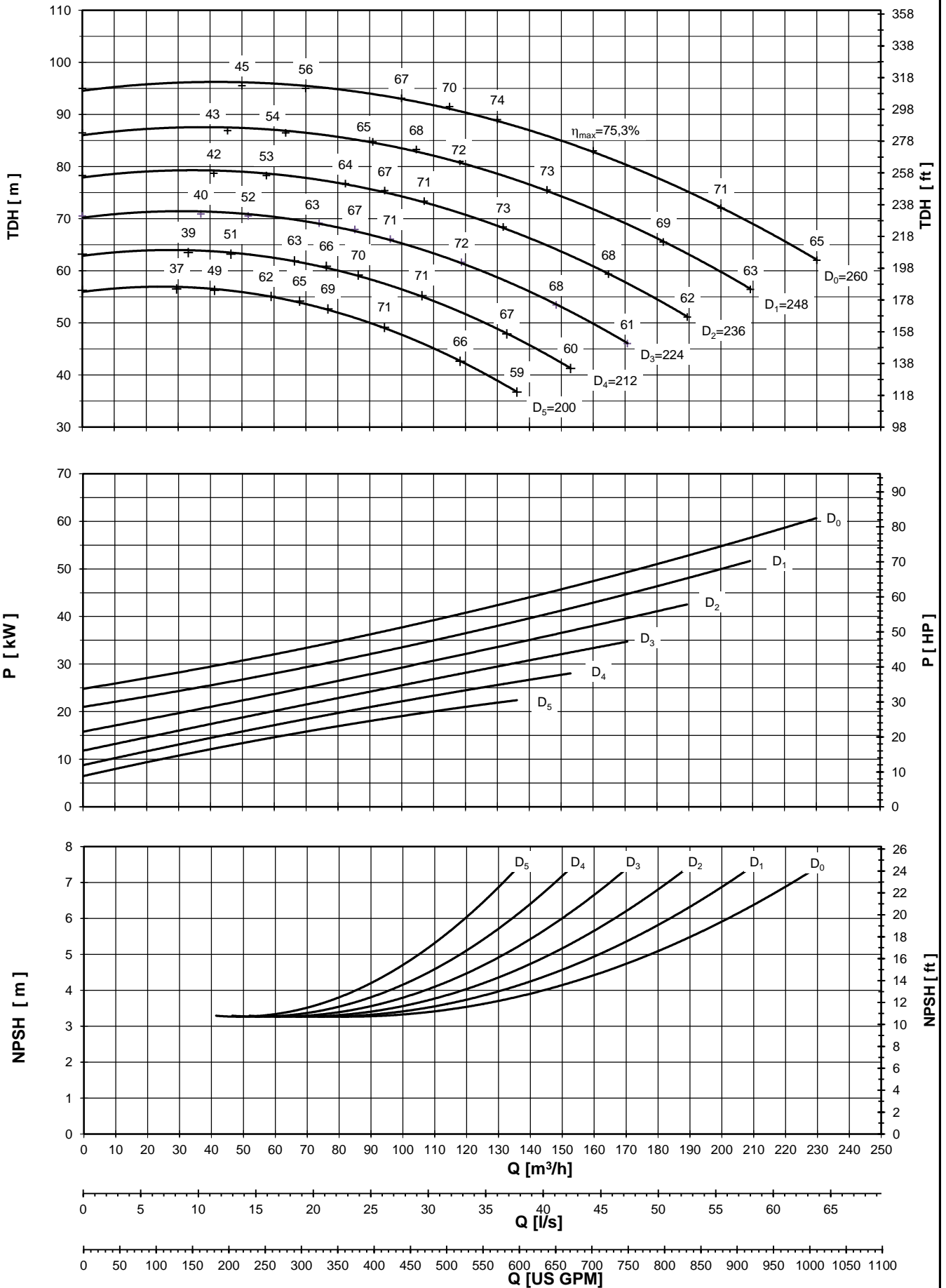

Performance curves are valid for clean cold water-kinematic viscosity 1 [mm²/s], density 1000 [kg/m³]. Methods and tolerances of presented performance curves are in accordance with ISO 9906 - Annex A



PUMP PERFORMANCE CURVES
No. 4HD.0163.05

PUMP TYPE
SCP 80 - 315
2900 [rpm]

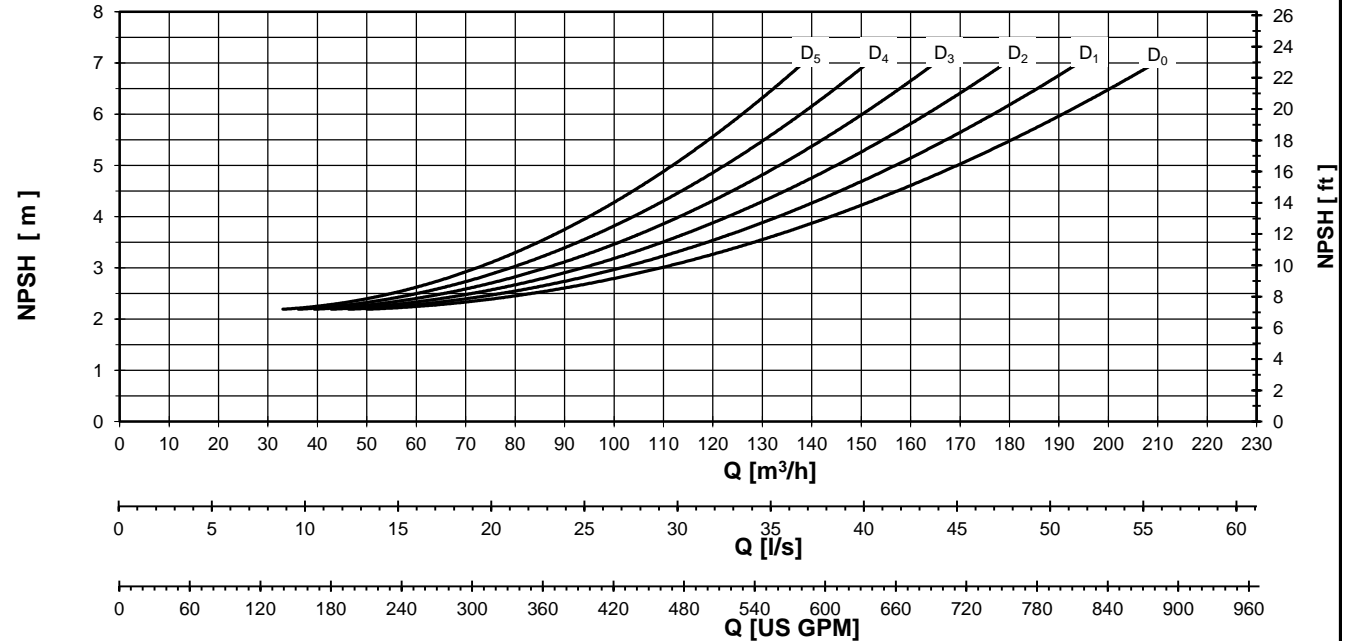
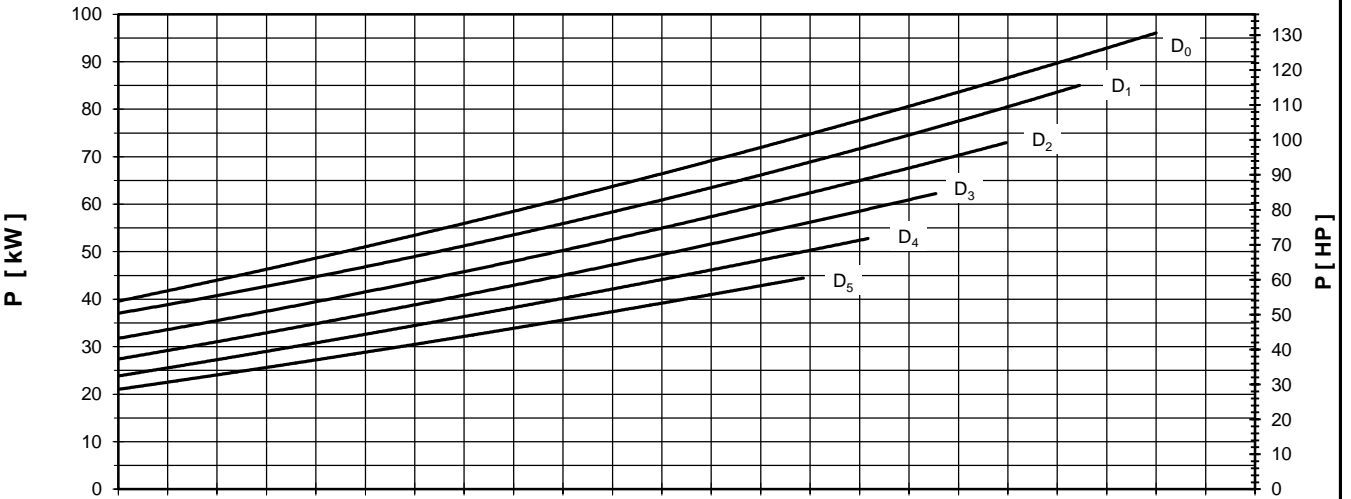
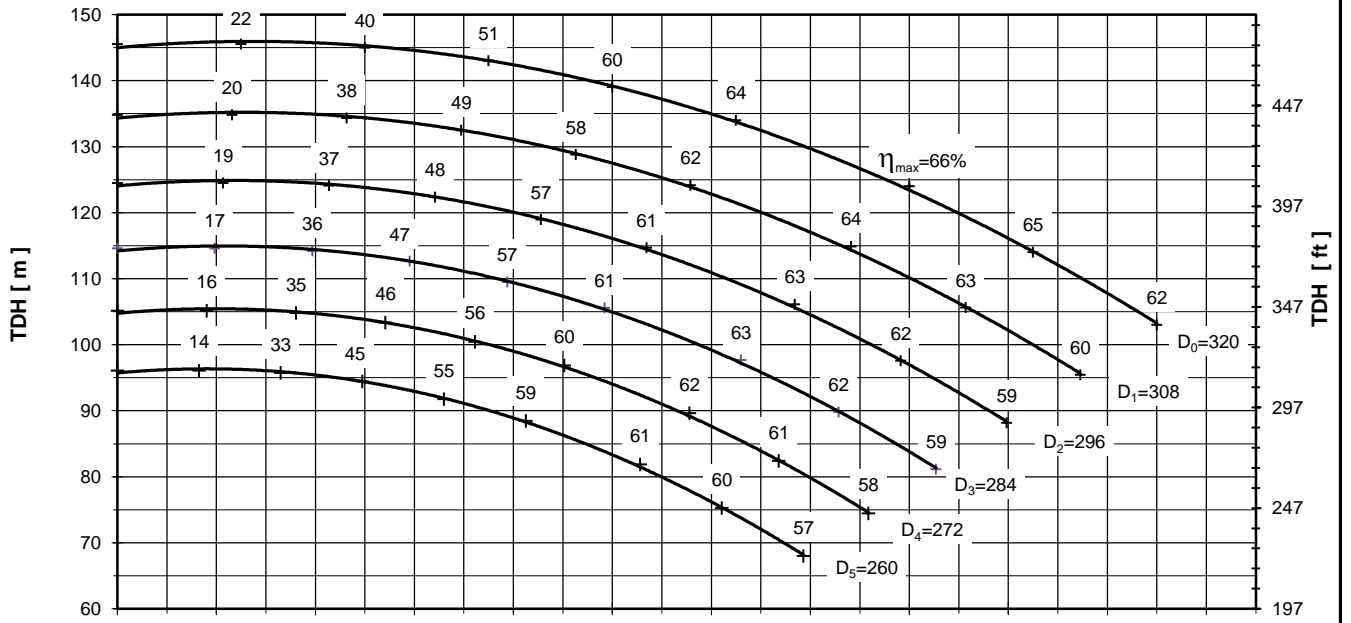

Performance curves are valid for clean cold water-kinematic viscosity 1 [mm²/s], density 1000 [kg/m³]. Methods and tolerances of presented performance curves are in accordance with ISO 9906 - Annex A

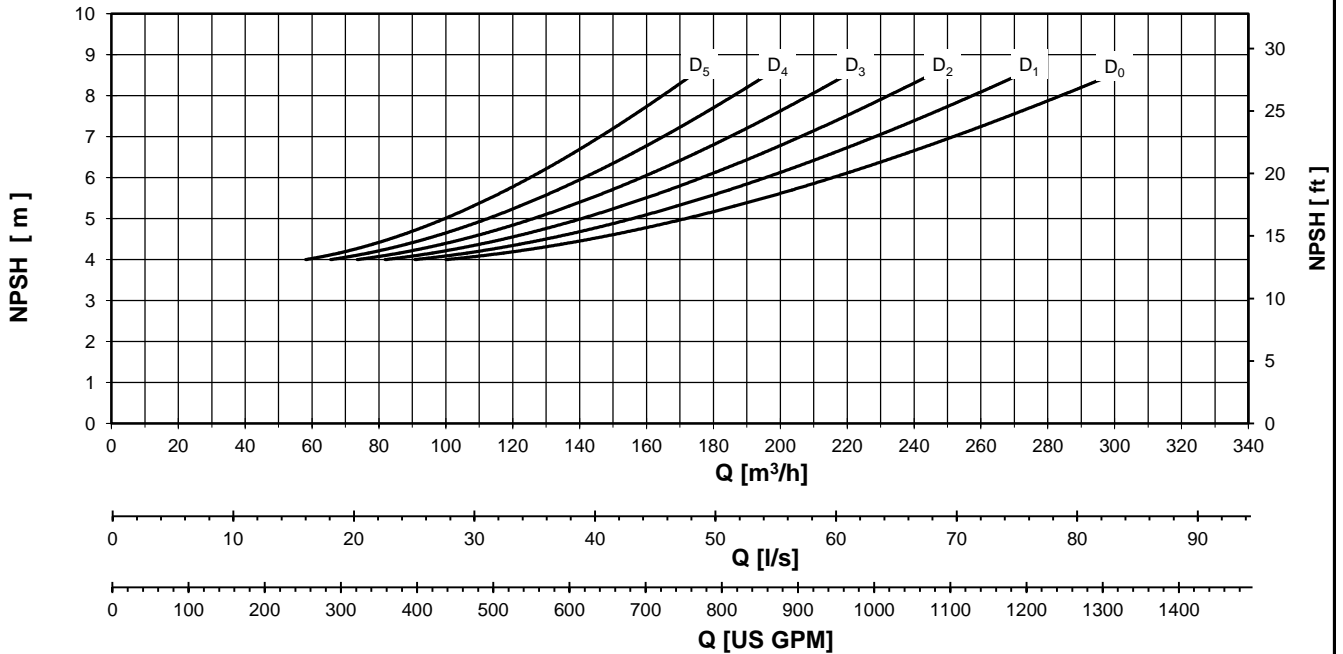
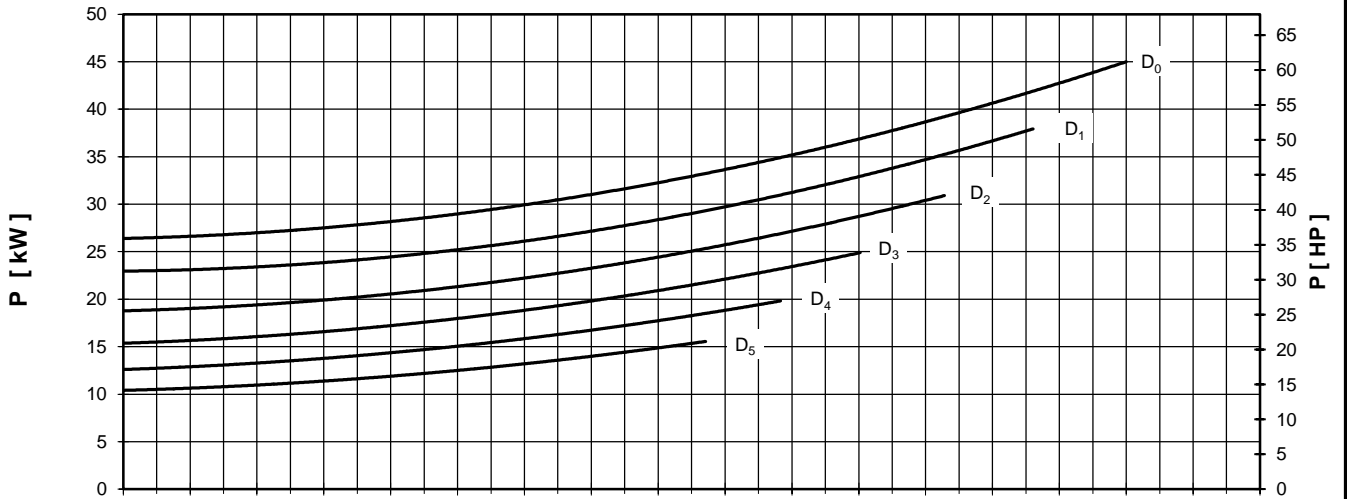
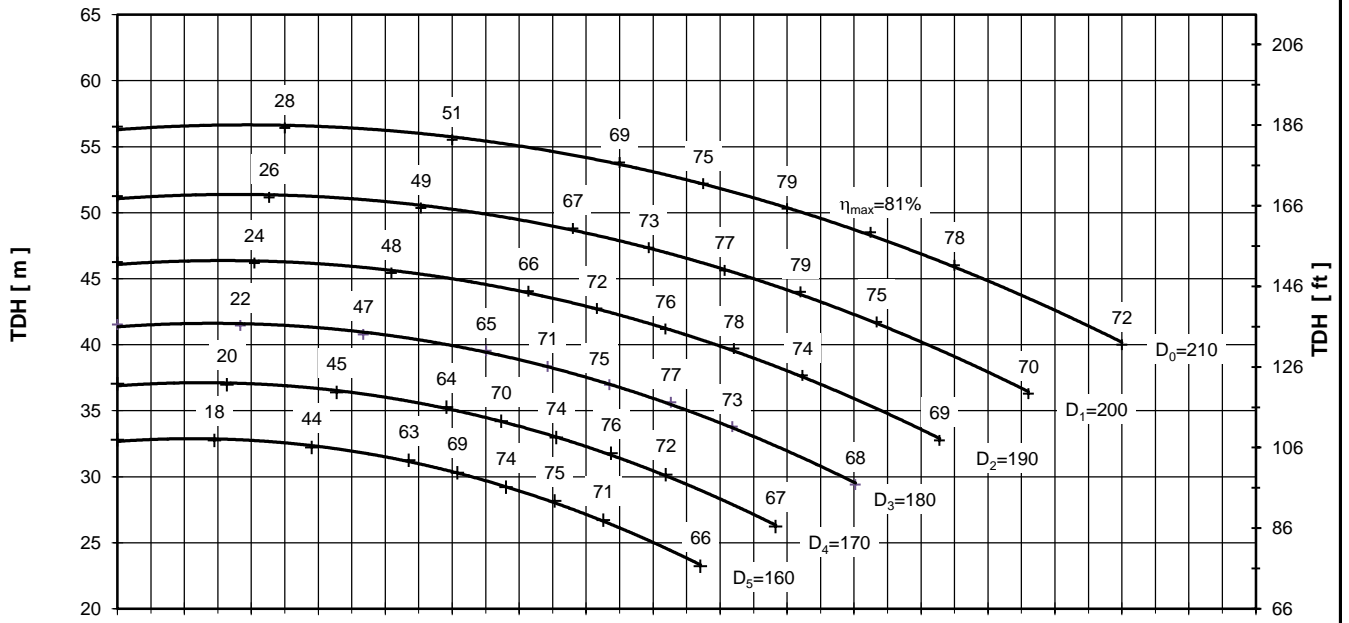

Performance curves are valid for clean cold water-kinematic viscosity 1 [mm²/s], density 1000 [kg/m³]. Methods and tolerances of presented performance curves are in accordance with ISO 9906 - Annex A

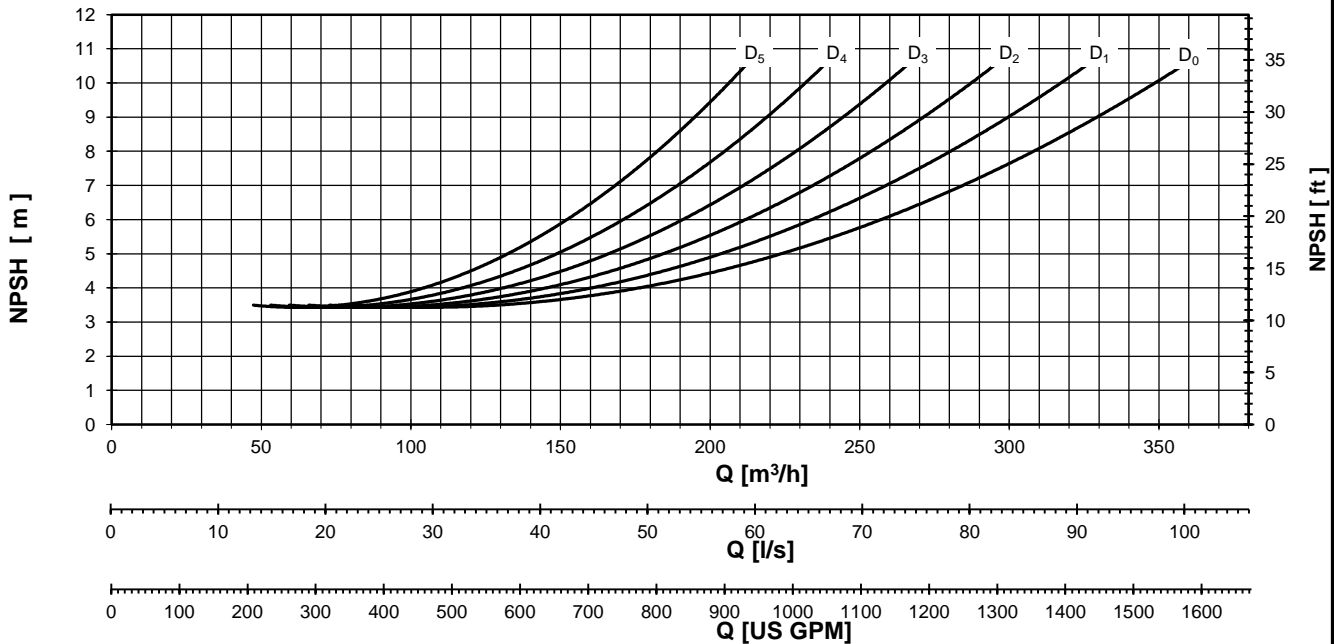
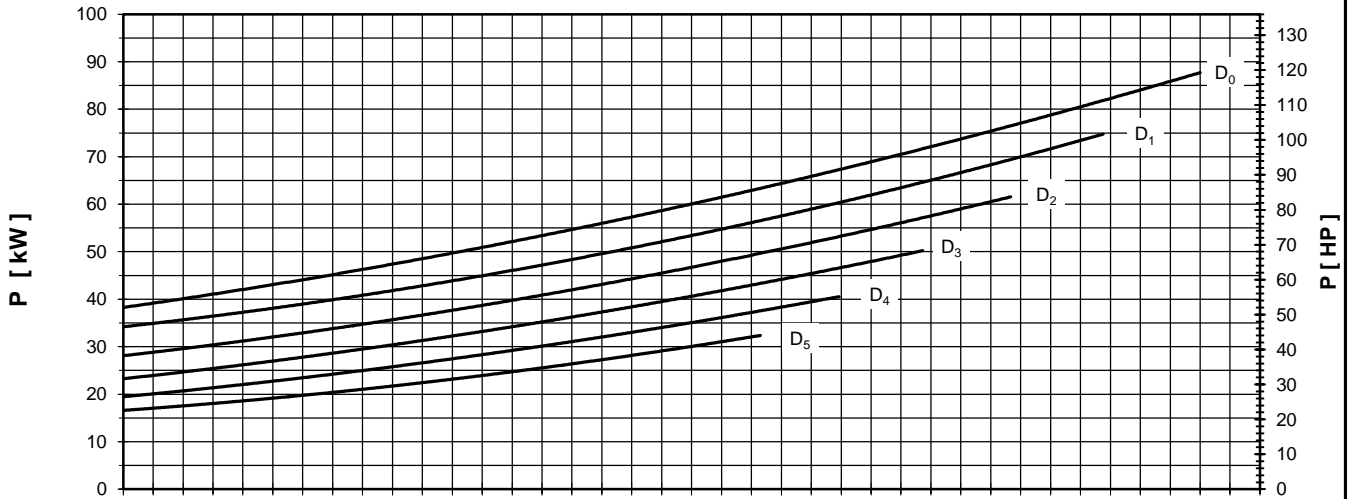
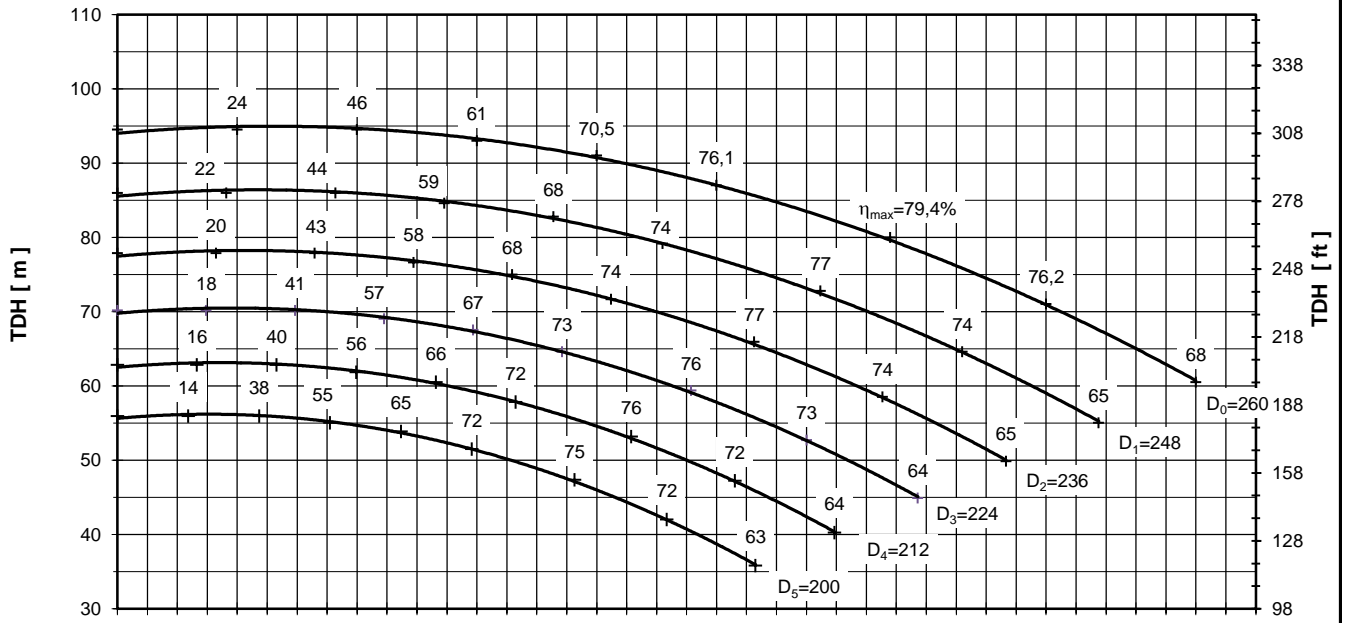



Pero Nakov Str. bb. 1000 Skopje, Republic of Macedonia
Tel. +389 2 2549 817 / 818, Fax. +389 2 2549 833 / 834
www.pumpi.com.mk; e-mail: info@pumpi.com.mk



QUALITY MANAGEMENT SYSTEM[™]
ISO 9001:2008

