

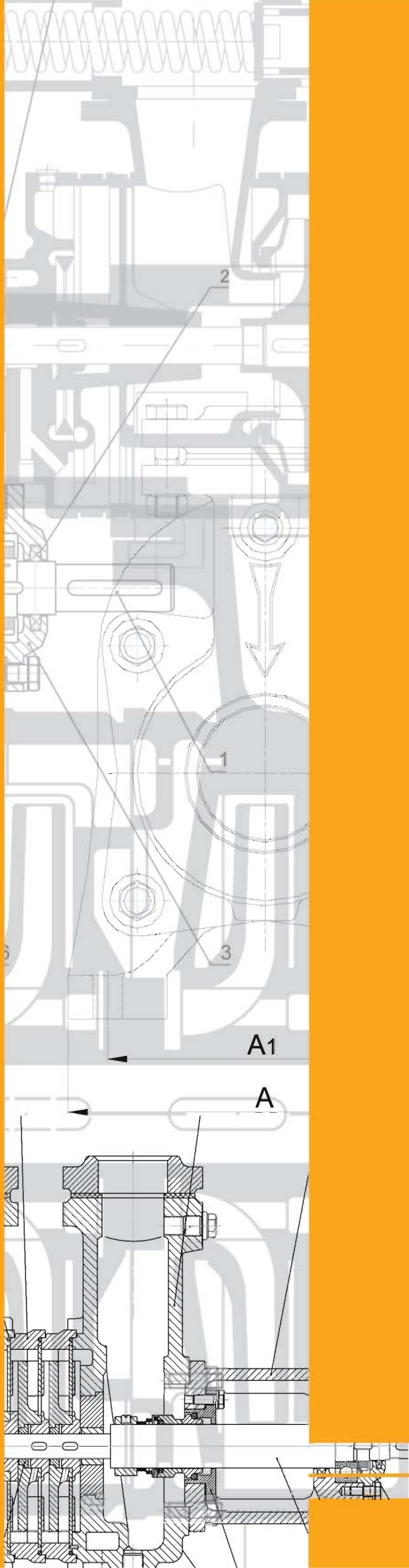

BCP-PETROL CENTRIFUGAL PUMPS





MZT Pumpi a.d is one of the leading manufacturers of industrial pumps in the region of South-East Europe. With its extensive experience of more than 60 years, justified with existence of broad product range, it continuously strives to satisfy the utmost needs of the customer.

The key elements to survive in this globalized market are flexibility towards market changes and ability to innovate-both in product designs as well as business processes. By following the worldwide development in the pump industry, our staff constantly faces with the growing challenge to keep abreast of the numerous innovations in pump designs and this is justified by having a separate R&D department.

The basic objective of MZT Pumpi is expanding the business partnerships and building the brand name of our products worldwide. All of our employees live up to our motto: "Pump your way to success".

CONTENT

GENERAL DATA	4
• Description	4
• Design details	5
• Cros sectional drawings of BCP60, BCP150, BCP200	7
• Cros sectional drawings of BCP10	8
• Sealing	9
• Bearings	9
• Balancing the axial thrust	9
• Over pressure valve	9
• Pump material list	10
TECHNICAL DATA	10
• Main dimensions of pump BCP 10	10
• Main dimensions of pump BCP 60	12
• Main dimensions of pump BCP 150	13
• Main dimensions of pump BCP 200	14
• Main dimensions of pump unit BCP10	15
• Main dimensions of pump unit BCP60	16
• Main dimensions of pump unit BCP150	17
• Main dimensions of pump unit BCP200	18
PERFORMANCE CURVES	19
• General performance curves	19
• Performance curves of BCP10	20
• Performance curves of BCP60	29
• Performance curves of BCP150	36
• Performance curves of BCP200	42

GENERAL DATA

Technical data:

Capacity: up to 50 l/s
Head: up to 200 m

Pump type key

Example:
petrol
centrifugal
pump
code

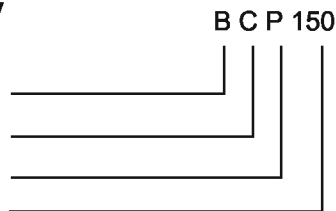

Design:

BCP petrol pumps are centrifugal, self priming, horizontal pumps. They are assigned for transport of all kinds of petrol and naphtha. They also could be used for transport of ammonia, benzol etc.

BCP pumps are designed as single stage and multistage. They can be driven by electric drive on the same base plate.

Self priming of the pump is made possible by means of a vacuum rotor which is enclosed in the pump.

With the transport of easily evaporable fluids, the conditions for cavity appearance are convenient. In due of it, a "cavity rotor" is buildin the pump, protecting the pump from cavity. In cases when the pipeline operation stops, the overflow valve enables continuation of the pump operation for a certain period, without switching the motor off. The circular fluid flow duration depends on the fluid temperature, which must not exceed 600C.

The support structure of the pump aggregate is made of steel profiles, welded in a corresponding lattice. Undisturbed, enduring operation of the pump is ensured by fluid transport which must not consist of hard articles.

Applications:

The BCP pumps are intended for pumping of volatile fluids saturated with air and steam without mechanical contaminants. Fluids that may be pumped include: petrol, naphtha, ammonia...

Main fields of application:

- Loading and discharging of tankers and lorry tanks, refinery process pump, petrol storage tanks...

Standard material executions:

In case of standard execution, the pump housing, intermediate stages and centrifugal impellers are made of gray iron, while the vacuum impeller and first cavitation impeller are made of bronze.

The shaft is made of high grade steel.

Bearing assembly:

The bearings are built-in BCP pumps. They are axial radial on discharge side, in addition to the main radial loadings they also accept the rest of the axial loadings which are not compensated in a hydraulic way. On the suction side, the bearings are enclosed in such way that enable axial spindle moving. This solution is suitable in due of temperature dilatations compensation of the drive spindle. During exploitation, the bearings are grease lubricated.

Shaft sealing:

Shaft sealing is an important element, with the BCP pumps, mechanical seals are applied, which are very suitable for easily evaporable fluid packing. The principle of mechanical seals operation is based on contact impermeability between two perfectly smooth surfaces. One of them is immovable and other rotates together with shaft. The resting force on the contact surfaces is realized by means of a spring. This elastic connection ensures a good packing.

The seals are cooled by the transport fluid and the realized connections between the seals.

■ Impellers (rotors)

Each pump consists of three kinds of impellers:

- Vacuum rotor (VR)
- Cavity rotor (KV)
- Centrifugal operating rotor (CRR)

The vacuum rotor forms sub pressure in the suction pipeline, thus ensuring self priming of the pump. The clearance between VR and body is minimal, so that the efficiency of vacuum formatting is large and self priming time is relatively short.

KR with its operation and suitable design gives to the current fluid a kinetic energy. The transmission of the KR turning moment is achieved by a flat rounded key, grooved in the shaft. The position of KR in a determined figured dimension in the shaft is fixed by means of a nut from one side, and distance bush from the other. KR is made of bronze in standard design.

CRR are of closed type. They are hydraulic unloaded by choke so that the ball bearings are only a little loaded by an axial force. CRR are fixed in the shaft with flat ball keys, grooved in the shaft under 90° for each next. CRR are made of bronze in standard design. The impellers are balanced by a rotary mass, so that the pump operation is steady and without harmful vibrations.

■ Over pressure valve

A delivery valve is build-in BCP pumps. Its duty is to ensure:

- Short term interruption of transfer without stopping the pump aggregate.
- Securing of the operating elements and the whole pump structure from a delivery hydraulic impact.
- Possibility of a pressure regulation in the discharge pipeline.

The casing is made of gray iron with manufactured slide surfaces for the valve and the valve seat leading.

The spring is so designed that ensures a regular and accurate limitary pressure regulation of the delivery valve.

The materials of all elements which are in contact with the operating fluid are resistant to its chemical and physical action.

During delivery valve operation fluid is unavoidably heated, in that aim in delivery valve design a thermostat is enclosed which acts upon the drive electro assembly of the electromotor when the operating fluid temperature exceeds 60°C, the thermostat stops the drive electromotor operation.

■ Performance

The performance curves are given in the diagrams bellow, indicating: Q-H, Q-P, Qefficiency, Q-NPSH. BCP pumps can operate continuously in whole the operating region within the motor power limitation.

All the pumps can run at different speeds, depending on the size of the pump and the customer requirements. For higher speeds it is necessary to check the pump limitation. The performance curves are based on a liquid density of 1000 kg/m³. For working fluid density below or above 1000 kg/m³ it is necessary to multiply the power.

■ Drive

The drive is generally a direct coupled electric motor, using a flexible coupling. For sizing of the drivers you have to add a minimum of 10 to 15% to the pump absorbed power, depending on operating condition, eventually a higher could necessary.



GENERAL DATA– Design of BCP pump

Self priming

A vacuum pump is incorporated in the pump so the self ability of the pump is dramatically improved

Flange connection

Execution of suction and discharge pump's connections according DIN 2502

Over pressure valve

Specially designed valve to avoid increasing of the outlet pressure above that the limited pressure

Pump shaft

The shaft of high grade steel is precisely machined and ground to minimize deflection and wearing of pumps parts and assure the mechanical seals long life.

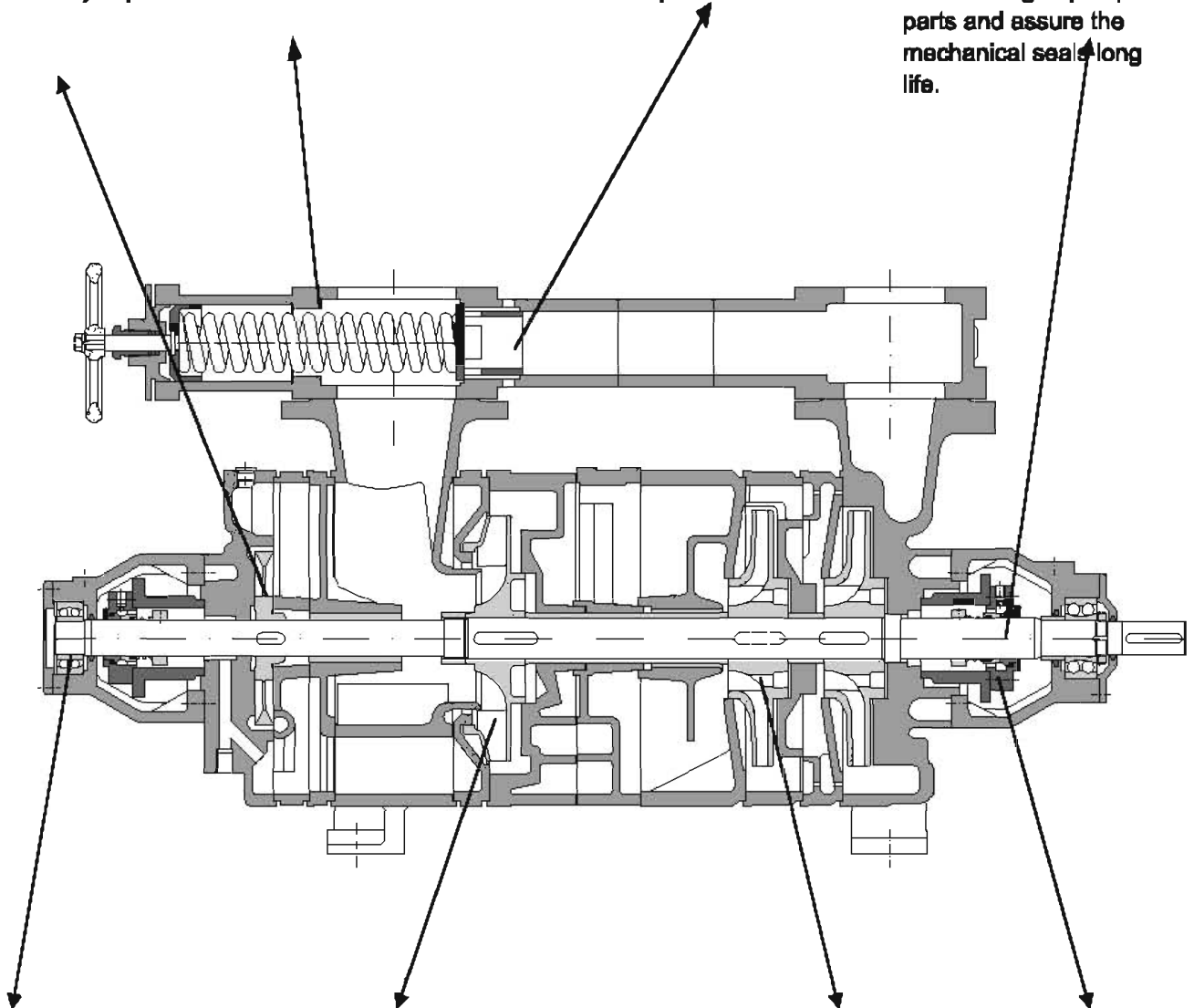

Bearings

Ample dimensioned bearings of roller type guide the pump shaft for smooth pump running and have long life service period

Cavitation Impeller

The first centrifugal impeller is designed with larger inlet eye and fluid's velocity is slowed to achieve best cavitation performance

Axial thrust

Through the holes into the impeller's hub the hydraulic axial forces are relieved, the rest of the thrust bears the roller bearing

Shaft sealing

Two mechanical seals of single spring type are mounted on both ends of the pump shaft

GENERAL DATA- Sectional drawing of BCP 60, BCP 150, BCP 200

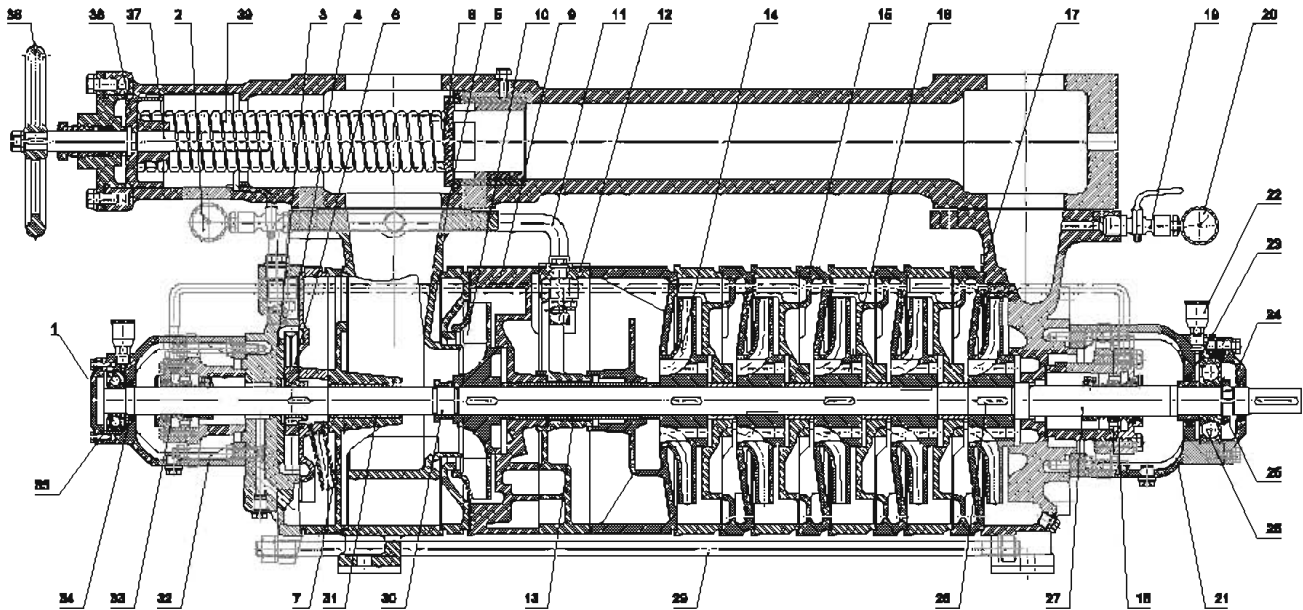

Pos.	Description	Pos.	Description
1.	Beck bearing cover	21.	Discharge console
2.	Vacuumeter	22.	Grease lubricator
3.	Vacuumrotor body	23.	Cord
4.	Stage casing	24.	Front bearing cover
5.	Suction casing	25.	Lock nut
6.	Vacuumrotor	26.	Ball bearing
7.	Stage casing	27.	Shaft
8.	Valve	28.	Key
9.	Stage casing with Impeller	29.	Double-ended screw
10.	Cavity rotor	30.	Lock nut
11.	Pipe connection	31.	Sleeve
12.	Stage casing	32.	Suction console
13.	Distance sleeve	33.	Mechanical seal
14.	Impeller	34.	Cord
15.	Stage casing	35.	Ball bearing
16.	Holes in impeller hub	36.	Valve wheel
17.	Discharge casing	37.	Valve spindle
18.	Mechanical seal	38.	Piston
19.	Cock R1/2 x R1/4	39.	Spring
20.	Manometer		

GENERAL DATA - Sectional drawing of BCP 10

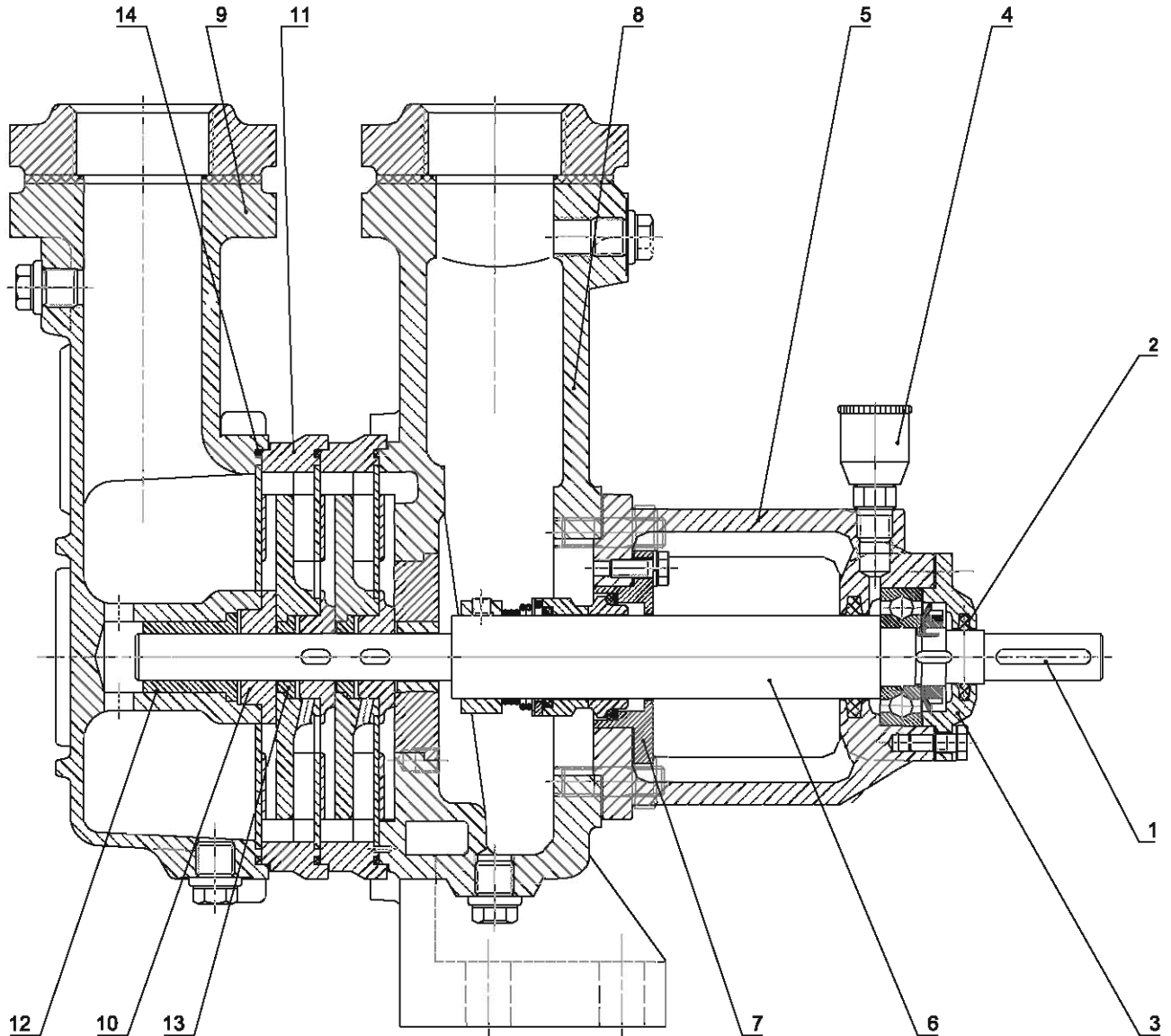

Pos.	Description	Pos.	Description
1.	Shaft key	8.	Discharge casing
2.	Cord gasket	9.	Suction casing
3.	Cover	10.	Impeller
4.	Grease lubricator	11.	Stage casing
5.	Bearing bracket	12.	Sleeve
6.	Shaft	13.	Bushing
7.	Seal gland	14.	"O"-ring

GENERAL DATA

Mechanical shaft seal

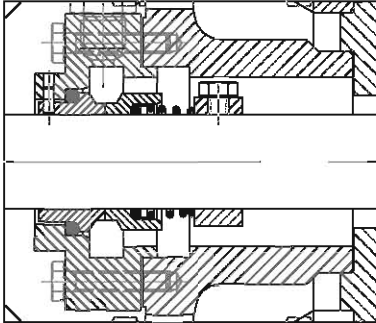

- There are two mechanical seals of single spring type and carbon-stainless steel face combination. On specific order types and material combinations of the mechanical seals are available

Bearing Bracket

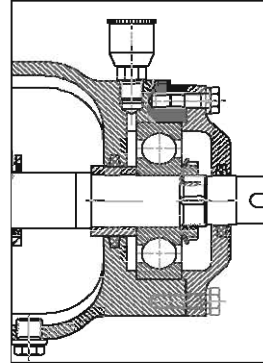

- Ample dimensioned bearings type guide the pump shaft for smooth pump running and long life service period. The roller bearings are grease lubricated through the nipples on both bearing's housing.

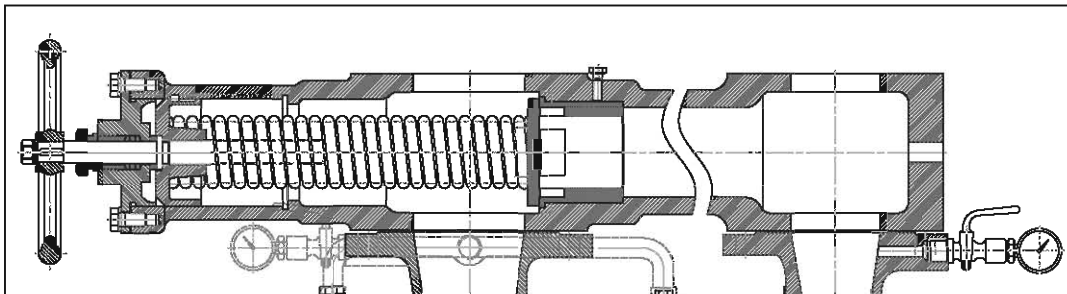

The suction and discharge side of the pump are connected through security pressure valve to avoid increasing of the outlet pressure above that the limited pressure

Balancing of the axial thrust

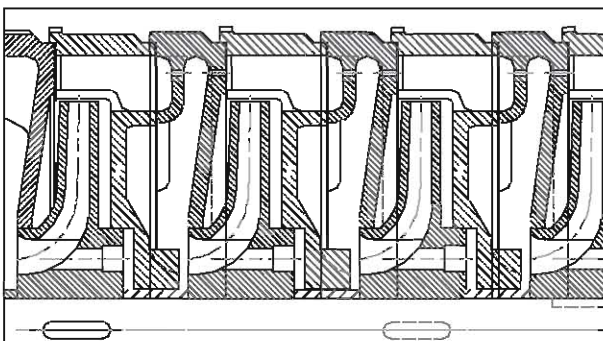

- Balancing holes provided in the impeller for balancing on hydraulic axial thrust

GENERAL DATA

Pump material list

Pos.	Component	Material	Optional mat.
1.	Pump case	GG	GGG,CS,SS,DSS,SDSS,BR
2.	Impeller	BR	GGG,CS,SS,DSS,SDSS,BR
3.	Shaft	SS	SS,DSS,SDSS
4.	Shaft sleeve	SS	SS,DSS,SDSS
5.	Bearing bracket	GG	GG,GGG

Legend:

- GG - Cast iron
- GGG - Ductile iron
- CS - Cast steel
- SS - Stainless steel
- DSS - Duplex stainless steel
- SDSS - Super duplex stainless steel
- BR - Bronze

TEHNICAL DATA – Main dimensions of BCP 10

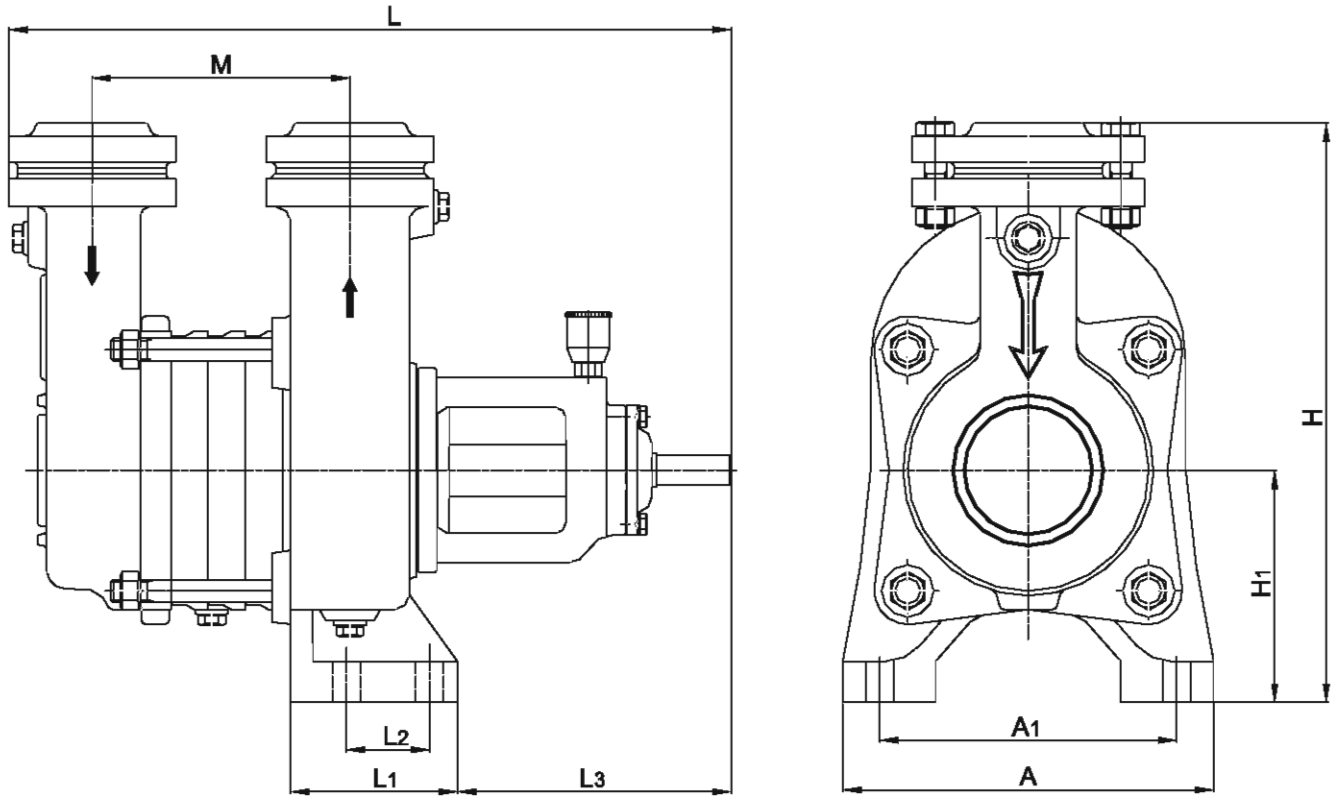

Pump type	rmp	M	L	L ₁	L ₂	L ₃	A	A ₁	H	H ₁	m (kg)
BCP10-2	2900	99	349.5	90	45	147.5	200	160	312	125	21
BCP10-3	2900	119	369.5								24
BCP10-4	2900	139	389.5								27
BCP10-5	2900	159	409.5								30
BCP10-6	2900	179	429.5								33
BCP10-7	2900	199	449.5								36
BCP10-8	2900	219	469.5								39
BCP10-9	2900	239	489.5								42
BCP10-10	2900	259	509.5								45

TEHNICAL DATA – Main dimensions of BCP 60

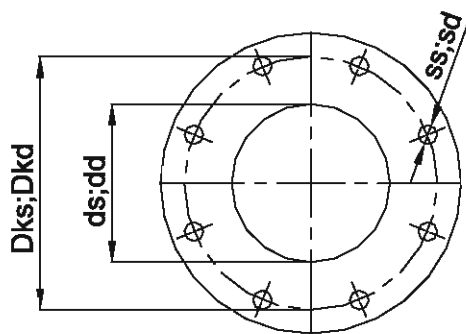
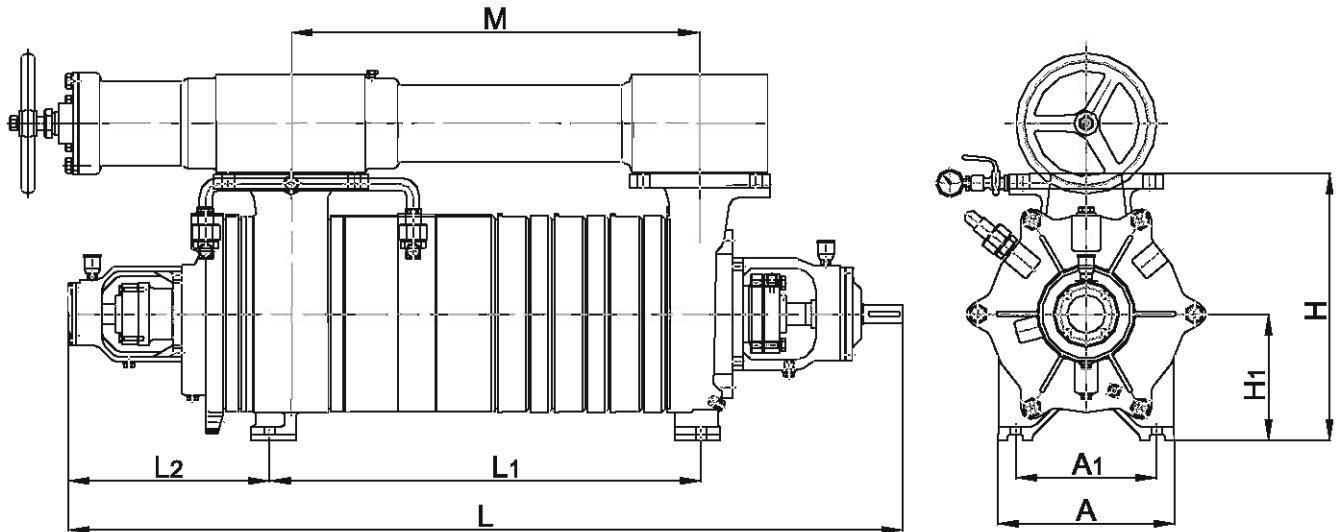

flanges:
accordingly to DIN 2502

Main flanges dimensions									DIN 2502
Du	Ku	du	Su	Zu	Dp	Kp	dp	Sp	Zp
220	180	100	18	8	200	160	80	18	4

Pump type	rmp	M	L	L ₁	L ₂	A	A ₁	H	H ₁	m (kg)
BCP60-1	1450	339.5	945.5	372.5	286	252	200	380	180	190
BCP60-2	1450	420	1026	453						215
BCP60-3	1450	500.5	1106.5	533.5						233
BCP60-4	1450	581	1187	614						251
BCP60-5	1450	661.5	1267.5	694.5						268

TEHNICAL DATA – Main dimensions of BCP 150

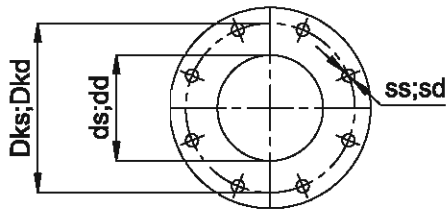
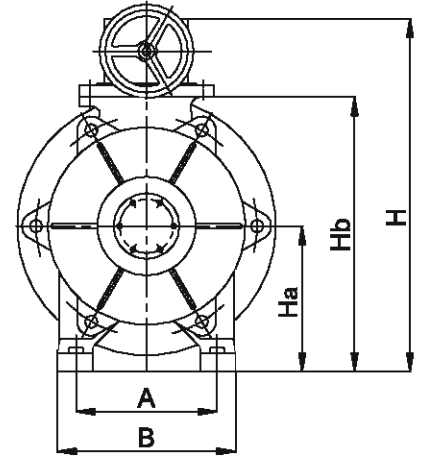
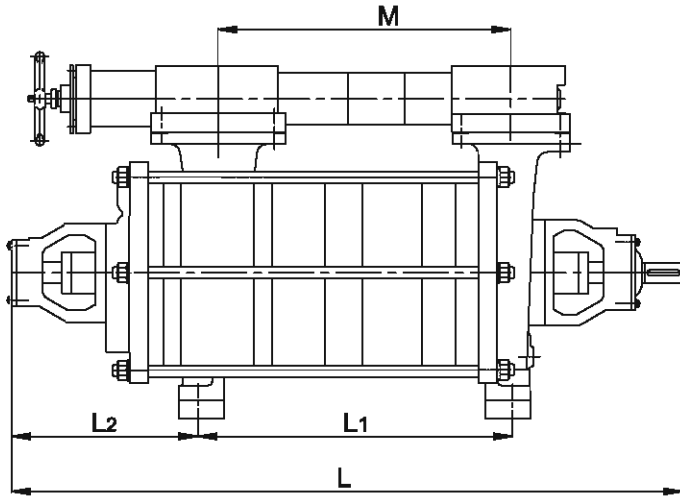

flanges:
accordingly to DIN 2502

Main flanges dimensions										DIN 2502	
Du	Ku	Du	Ku	du	Su	Zu	Dp	Kp	dp	Sp	Zp
220	180	285	240	150	23	8	250	210	125	18	8

Pump type	rmp	M	L	L ₁	L ₂	A	B	H	Hb	Ha	m (kg)
BCP150-1	1450	502	1273	550	361	300	380	710	570	270	410
BCP150-2	1450	622	1393	670							465
BCP150-3	1450	742	1513	790							520
BCP150-4	1450	862	1633	910							575
BCP150-5	1450	982	1753	1030							630
BCP150-6	1450	1102	1873	1150							685

TEHNICAL DATA – Main dimensions of BCP 200

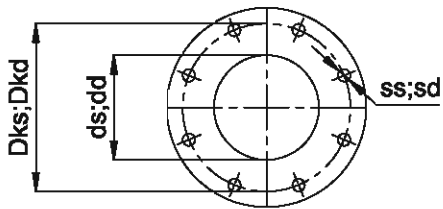
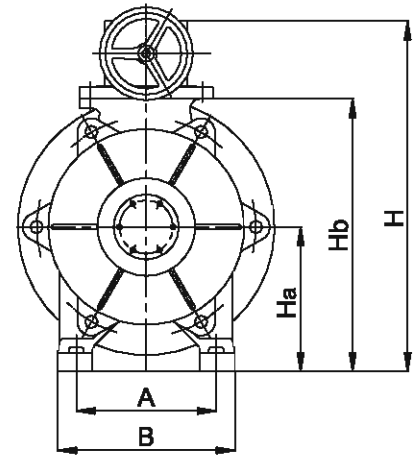
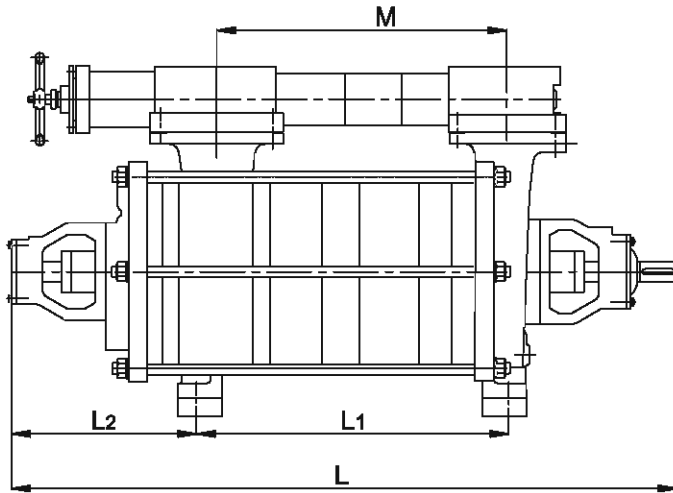

flanges:
accordingly to DIN 2502

Main flanges dimensions										DIN 2502	
Du	Ku	Du	Ku	du	Su	Zu	Dp	Kp	dp	Sp	Zp
220	180	285	240	150	23	8	250	210	125	18	8

Pump type	rmp	M	L	L ₁	L ₂	A	B	H	Hb	Ha	m (kg)
BCP200-1	1450	502	1308	548	396	300	380	710	570	270	410
BCP200-2	1450	622	1428	668							465
BCP200-3	1450	742	1548	788							520
BCP200-4	1450	862	1668	908							575
BCP200-5	1450	982	1788	1028							630
BCP200-6	1450	1102	1908	1148							685

TEHNICAL DATA – Main dimensions of BCP 10

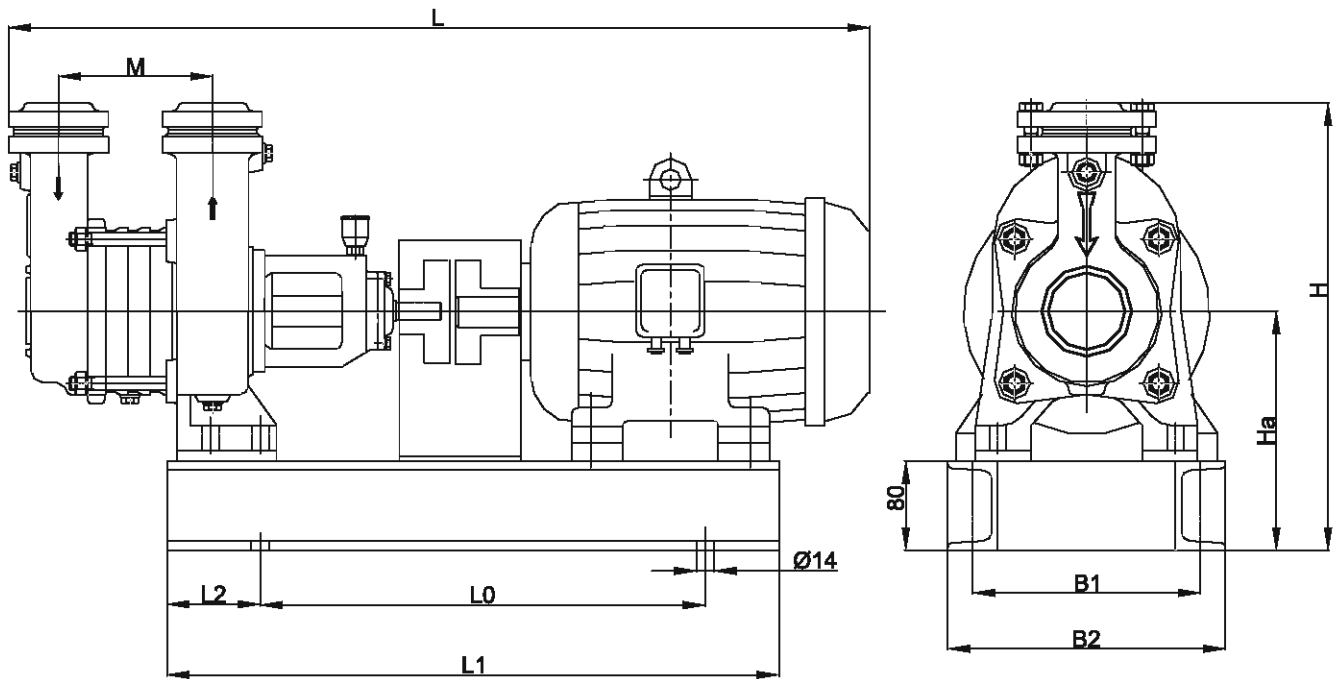

Pump type	rpm	kW	M	L	L ₀	L ₁	L ₂	B ₁	B ₂	H _a	H	G (kg)	
												pump	agg.
BCP10-2	2900	1.1	99	628	330	455	55	160	200	215	402	21	48
BCP10-3	2900	1.5	119	680	345	470	55	160	200	215	402	24	55
BCP10-3/1	2900	2.2	119	715	385	515	80	155	200	205	365	27	62
BCP10-4	2900	2.2	139	730	360	495	55	160	200	215	402	27	62
BCP10-4/4	1450	0.55	139	680	430	580	80	128	174	204	365	36	85
BCP10-5	2900	2.2	159	750	360	495	55	160	200	215	402	30	65
BCP10-6	2900	3	179	805	380	525	55	170	210	215	402	33	82
BCP10-7	2900	3	199	824	380	525	55	170	210	215	402	36	85
BCP10-8	2900	4	219	855	390	535	55	180	220	215	402	39	104
BCP10-9	2900	4	239	875	390	535	55	180	220	215	402	42	108

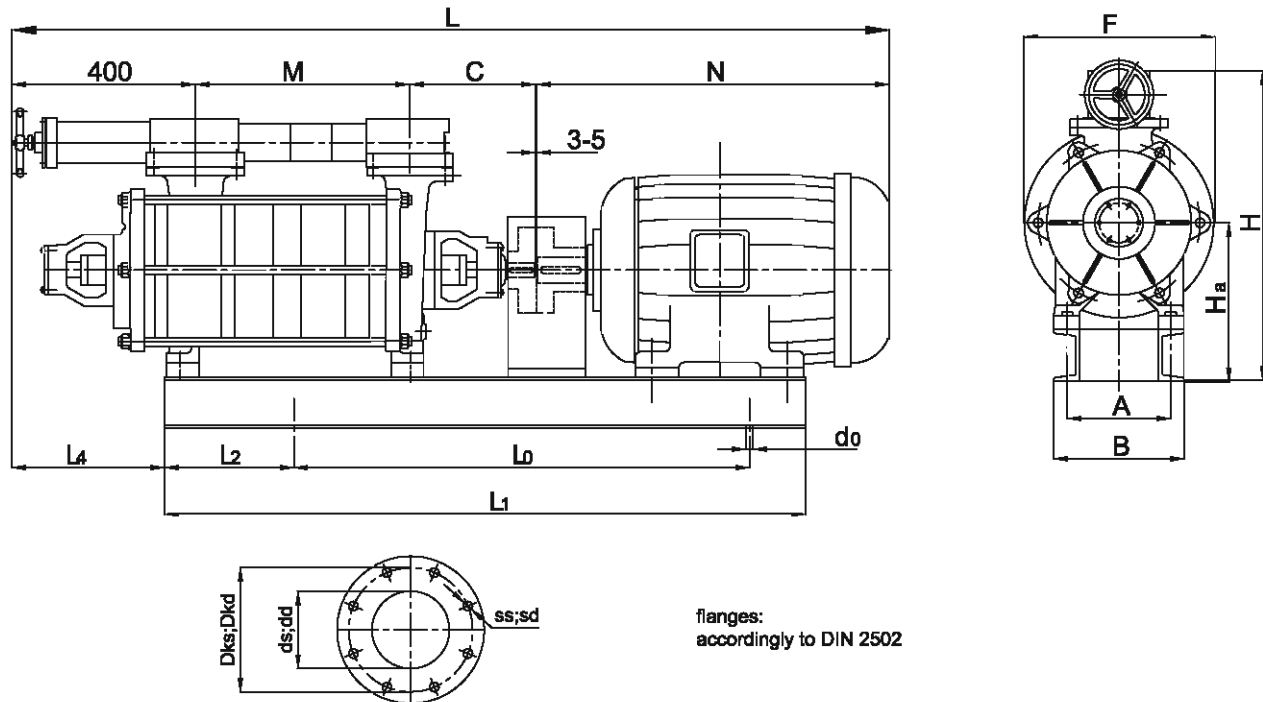
TEHNICAL DATA – Main dimensions of BCP 60

Main flanges dimensions								DIN 2502	
D _s	K _s	D _s	S _s	Z _s	D _d	K _d	D _d	S _d	Z _d
220	180	100	18	8	200	160	80	18	4

Main pump dimensions (mm)																	
Pump size	kW	N	L	L ₀	L ₁	L ₂	L ₄	A	B	M	H	H _a	d ₀ /z	F	C	G (kg)	
																pump	unit
BCP 60-1	5.5	441	1474	720	1035	220	342	230	280	339.5	653	312	18/4	340	289	190	378
BCP 60-1a	5.5	441	1474	720	1035	220	342	230	280	339.5	653	312	18/4	340	289	190	378
BCP 60-1b	4	380	1413	680	995	220	342	230	280	339.5	653	312	18/4	340	289	190	360
BCP 60-1c	4	380	1413	680	995	220	342	230	280	339.5	653	312	18/4	340	289	190	360
BCP 60-2	7.5	479	1592	780	1150	255	342	230	280	420	653	312	18/4	340	289	215	417
BCP 60-2 a	7.5	479	1592	780	1150	255	342	230	280	420	653	312	18/4	340	289	215	417
BCP 60-2b	5.5	441	1555	765	1115	255	342	215	270	420	653	312	18/4	340	289	215	405
BCP 60-2c	5.5	441	1555	765	1115	255	342	215	270	420	653	312	18/4	340	289	215	405
BCP 60-3	11	589	1782	885	1315	300	342	245	325	500.5	693	352	18/4	340	289	233	475
BCP 60-3a	11	589	1782	885	1315	300	342	245	325	500.5	693	352	18/4	340	289	233	475
BCP 60-3b	7.5	479	1672	800	1235	300	342	230	270	500.5	653	312	18/4	340	289	233	425
BCP 60-3c	7.5	479	1672	800	1235	300	342	230	270	500.5	653	312	18/4	340	289	233	425
BCP 60-4	15	633	1908	955	1440	335	342	285	345	581	653	312	18/4	340	289	251	581
BCP 60-4a	11	589	1864	765	1410	345	342	285	325	581	693	352	22	340	289	251	556
BCP 60-4b	11	589	1864	765	1410	345	342	285	325	581	693	352	22	340	289	251	556
BCP 60-5	18.5	652	2006	1000	1560	370	342	285	350	661.5	661	320	18	340	289	268	581
BCP 60-5a	15	633	1988	1000	1520	370	342	285	345	661.5	653	312	18	340	289	268	557
BCP 60-5b	15	633	1988	1000	1520	370	342	285	345	661.5	653	312	18	340	289	268	557

TEHNICAL DATA – Main dimensions of BCP 150

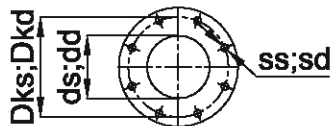
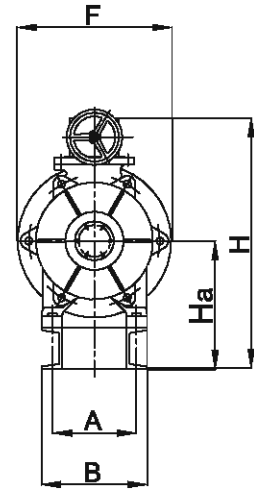
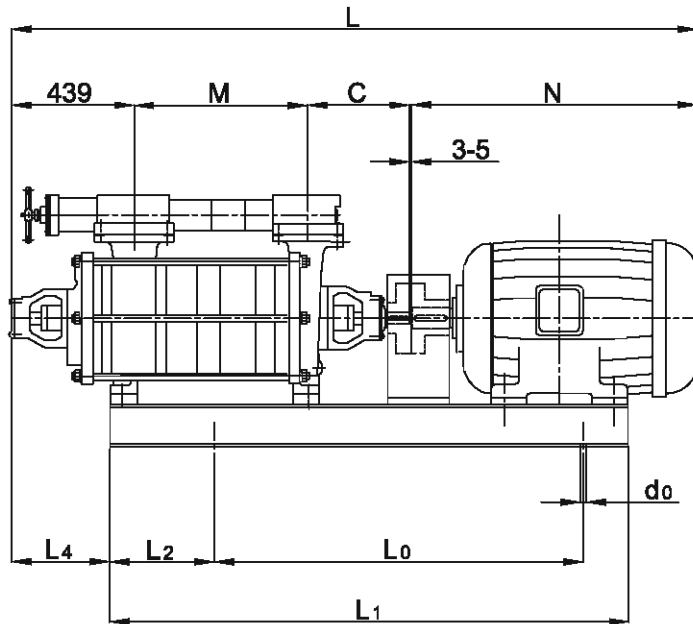

flanges:
accordingly to DIN 2502

Main flanges dimensions										DIN 2502	
Ds	Ks	Ds	Ks	ds	Ss	Zs	Dd	Kd	dd	Sd	Zd
220	180	285	240	150	23	8	250	210	125	18	8

Pump size	kW	Main pump dimensions (mm)														G (kg)	
		N	L	L ₀	L ₁	L ₂	L ₄	A	B	M	H	Ha	d ₀ /z	F	C	pump	unit
BCP 150-1	30	756	2068	1030	1550	320	356	330	390	502	890	450	22	474	367	410	800
BCP 150-1a	30	756	2068	1030	1550	320	356	330	390	502	890	450	22	474	367	410	800
BCP 150-1b	30	756	2068	1030	1550	320	356	330	390	502	890	450	22	474	367	410	800
BCP 150-1c	22	690	2002	1000	1500	320	356	320	380	502	890	450	22	422	367	410	700
BCP 150-1d	18.5	652	1965	1000	1475	320	356	330	380	502	885	445	22	422	367	410	680
BCP 150-2	45	830	2262	1165	1760	380	356	395	460	622	885	445	22	546	367	465	975
BCP 150-2a	45	830	2262	1165	1760	380	356	395	460	622	885	445	22	546	367	465	975
BCP 150-2b	37	805	2238	1125	1710	380	356	395	460	622	885	445	22	546	367	465	845
BCP 150-2c	30	756	2188	1090	1670	380	356	330	390	622	885	445	22	474	367	465	855
BCP 150-2d	30	756	2188	1090	1670	380	356	330	390	622	885	445	22	474	367	465	855

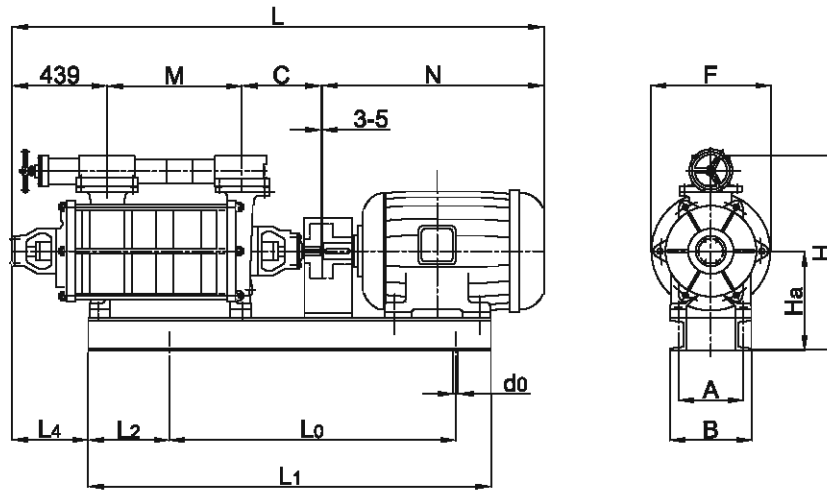
TEHNICAL DATA – Main dimensions of BCP 200

 flanges:
accordingly to DIN 2502

Main flanges dimensions								DIN 2502	
Ds	Ks	ds	Ss	Zs	Dd	Kd	dd	Sd	Zd
285	240	150	23	8	250	210	125	18	8

Main pump dimensions (mm)															G (kg)		
Pump size	kW	N	L	L ₀	L ₁	L ₂	L ₄	A/Ao	B/Bo	M	H	Ha	d ₀	F	C	pump	unit
BCP 200-1	37	805	2118	1070	1590	320	356	330/375	390/435	502	880	440	22	546	367	410	830
BCP 200-1a	37	805	2118	1070	1590	320	356	330/375	390/435	502	880	440	22	546	367	410	830
BCP 200-1b	30	756	2068	1020	1550	320	356	330	390	502	880	440	22	474	367	410	760
BCP 200-1c	30	756	2068	1020	1550	320	356	330	390	502	880	440	22	474	367	410	760
BCP 200-2	55	906	2338	1180	1825	380	356	330/440	380/506	622	890	450	22	597	367	465	1095
BCP 200-2a	45	830	2270	1140	1720	380	356	395	460	622	885	445	22	546	367	465	967
BCP 200-2b	45	830	2270	1140	1720	380	356	395	460	622	885	445	22	546	367	465	967
BCP 200-2c	37	805	2238	1125	1695	380	356	395	460	622	885	445	22	546	367	465	887
BCP 200-3	75	973	2525	1270	2010	440	356	330/495	390/557	742	890	450	22	634	367	520	1245
BCP 200-3a	55	906	2458	1290	1945	380	356	330/440	380/506	742	890	450	22	597	367	520	1163
BCP 200-3b	55	906	2458	1290	1945	380	356	330/440	380/506	742	890	450	22	597	367	520	1163
BCP 200-4	90	1024	2698	1355	2160	500	356	330/495	380/557	862	890	450	22	634	367	575	1380
BCP 200-4a	75	973	2645	1355	2109	500	356	330/495	380/557	862	890	450	22	634	367	575	1310
BCP 200-4b	75	973	2645	1355	2109	500	356	330/495	380/557	862	890	450	22	634	367	575	1310
BCP 200-5	110	1292	3085	1470	2350	555	356	330/565	380/628	982	940	500	22	708	367	630	1590
BCP 200-5a	90	1024	2816	1470	2082	555	356	330/565	380/628	982	940	500	22	634	367	630	1450
BCP 200-6	132	1153	3065	1470	2495	555	356	330/565	390/630	1102	938	498	22	708	367	685	1750
BCP 200-6a	132	1153	3065	1470	2495	555	356	330/565	390/630	1102	938	498	22	708	367	685	1650

General performance curves

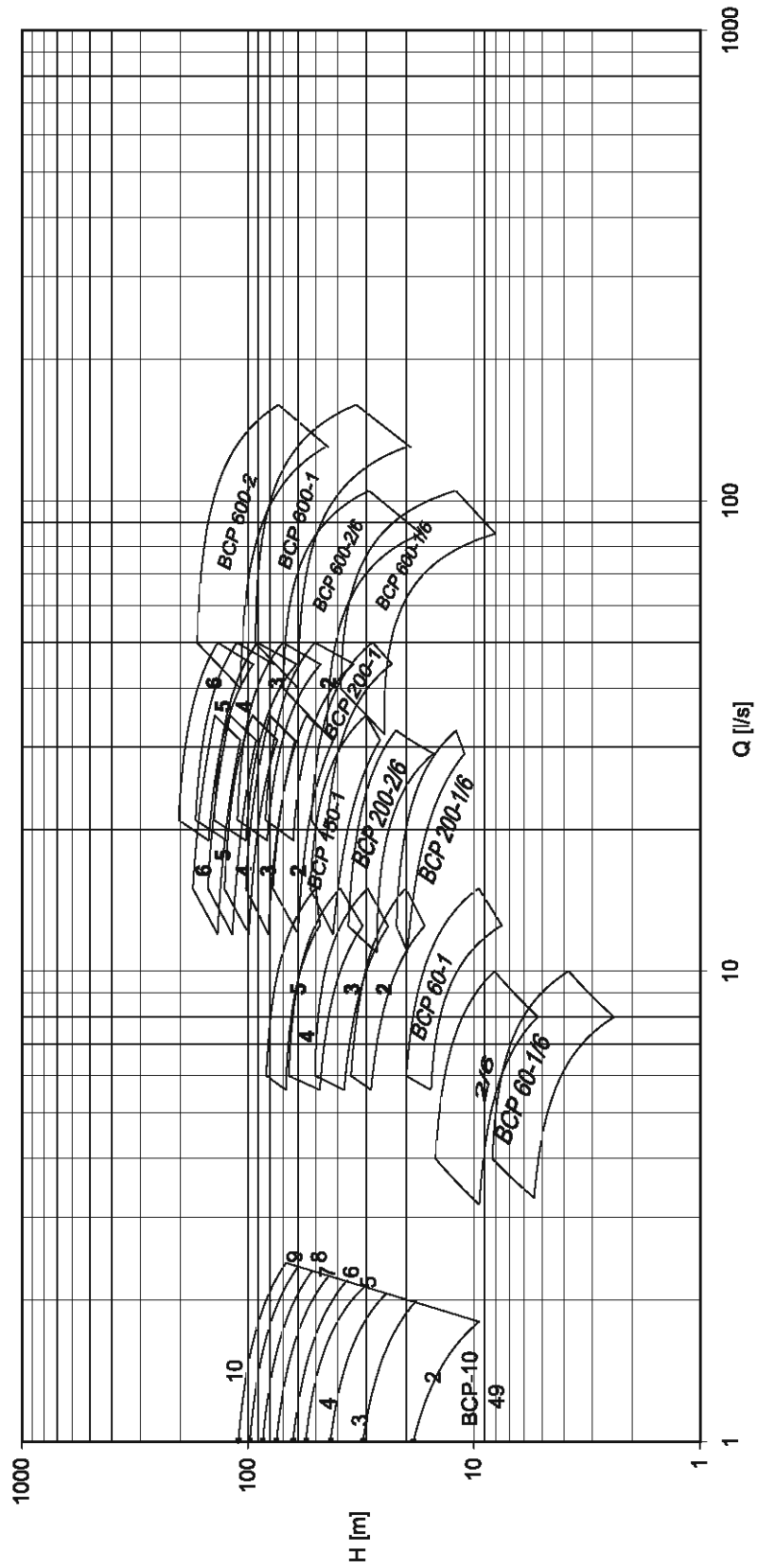
BCP - PUMPS



Pump performance curves

BCP10-2
n =2900 (rpm)

Total
Differential
Head

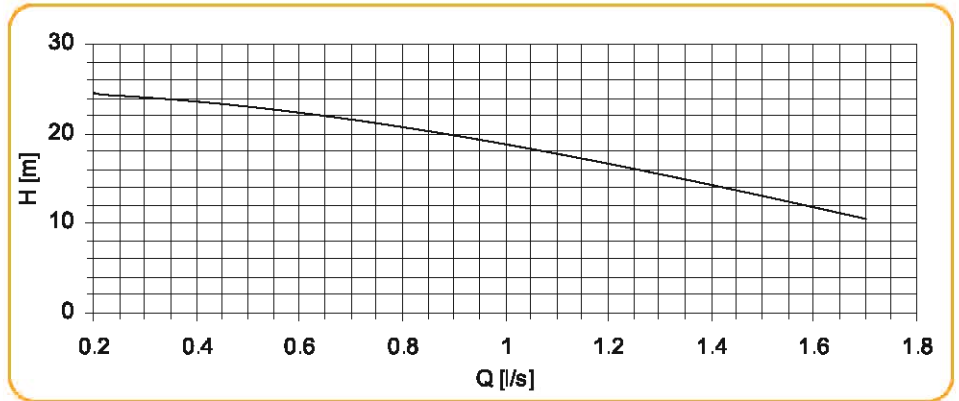

Power Input

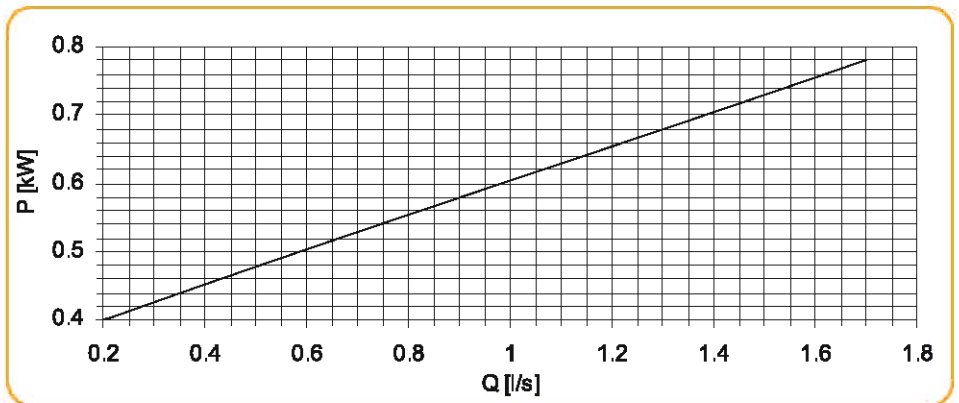

Efficiency

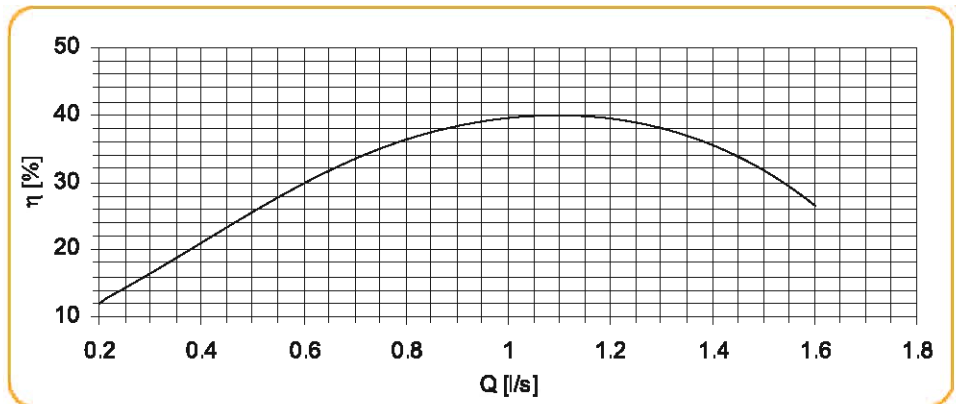

Pump performance curves

Total
Differential
Head

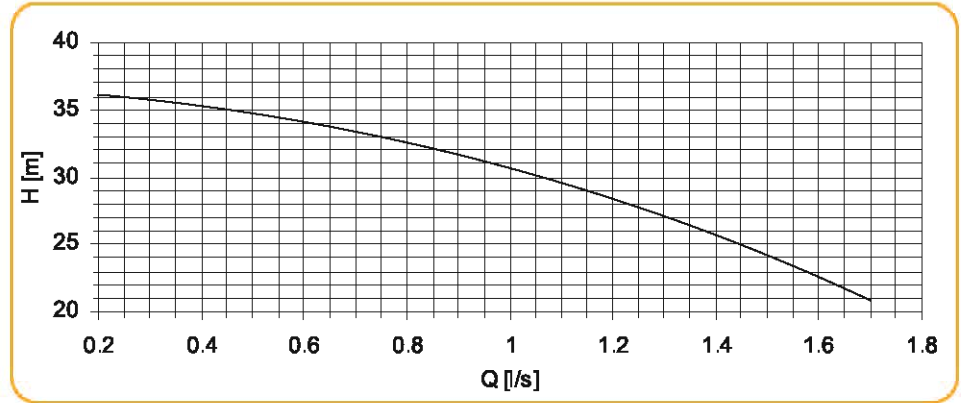

Power Input

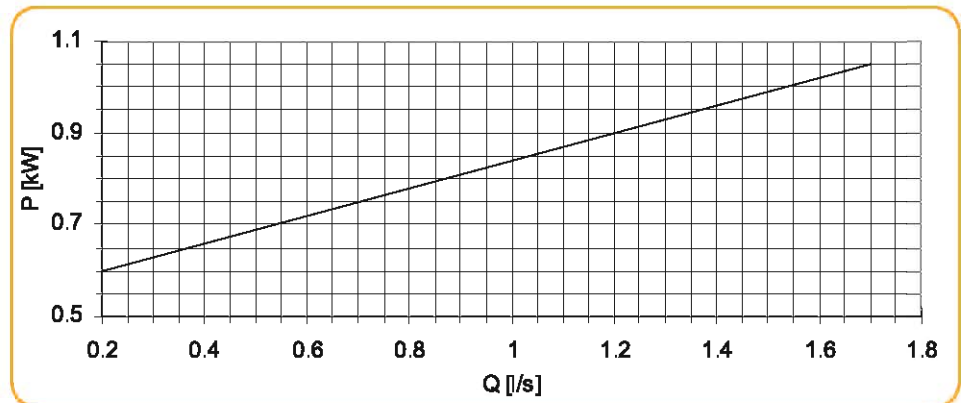

Efficiency

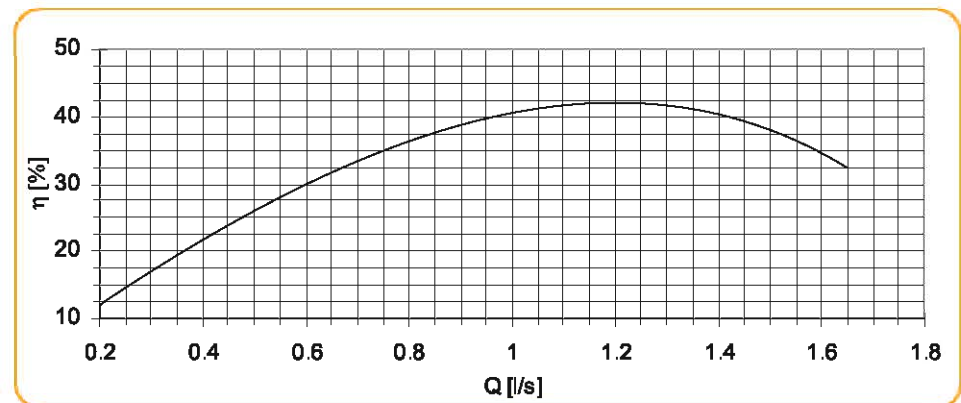

Pump performance curves

BCP10-4
n =2900 (rpm)

Total
Differential
Head

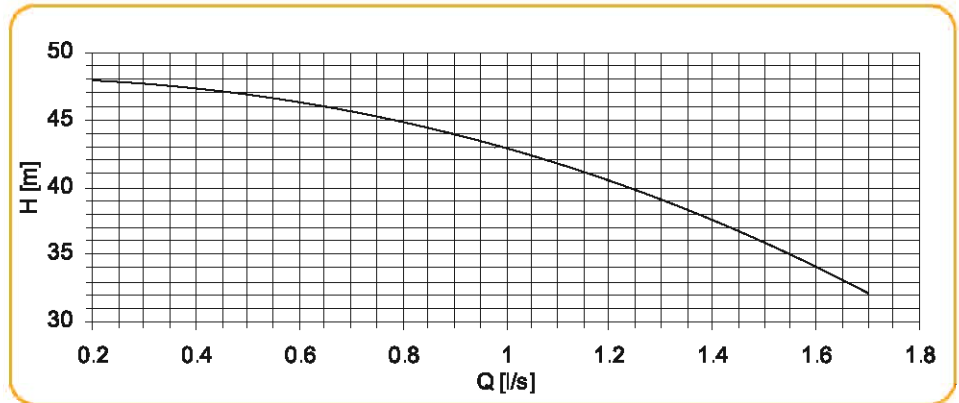

Power Input

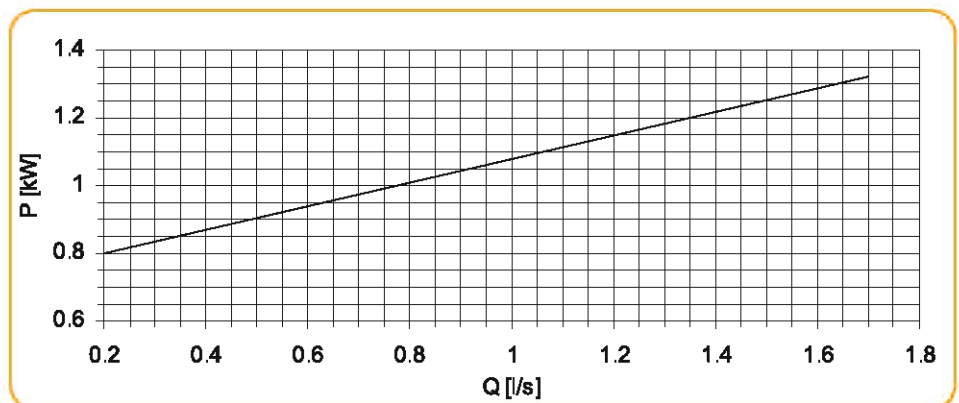

Efficiency

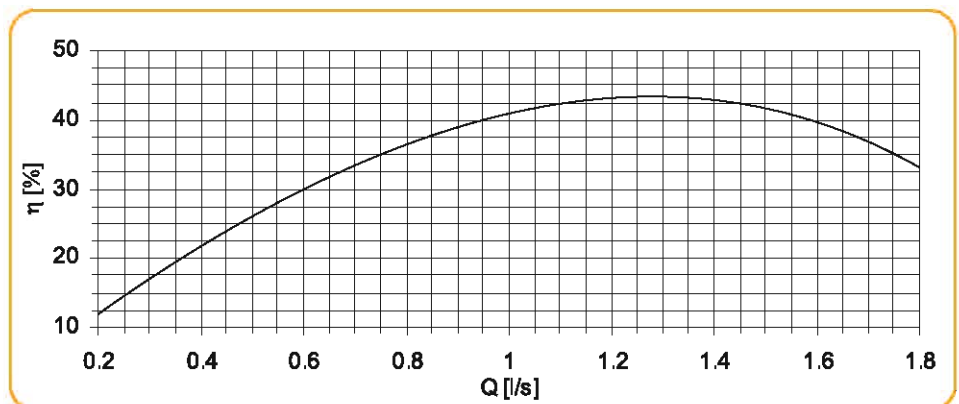

Pump performance curves

Total
Differential
Head

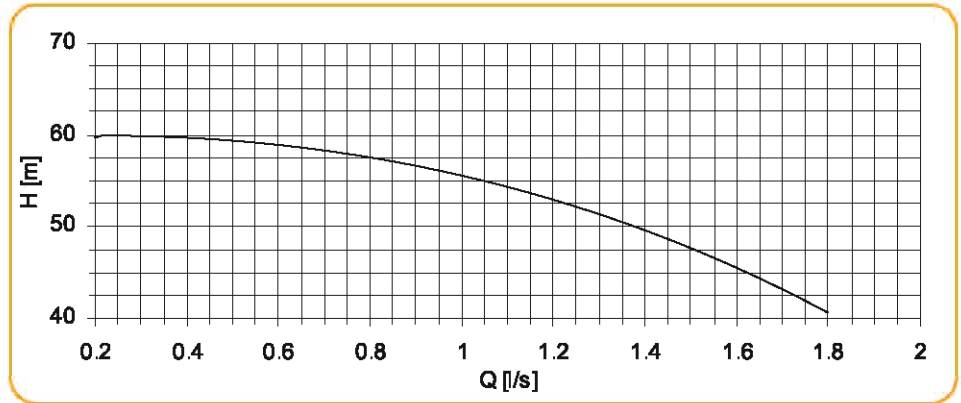

Power Input

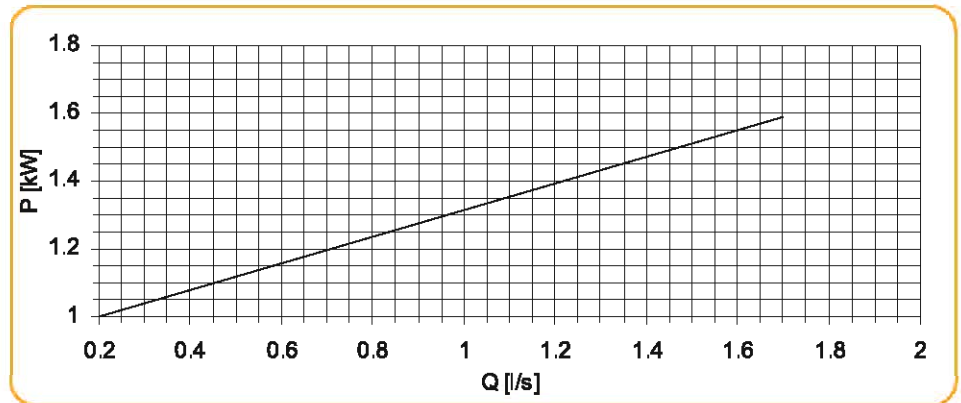

Efficiency

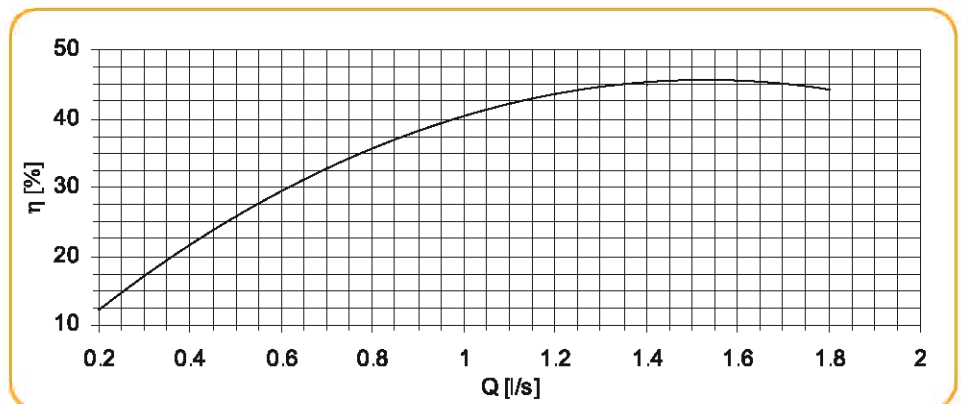

Pump performance curves

BCP10-6
n =2900 (rpm)

Total
Differential
Head

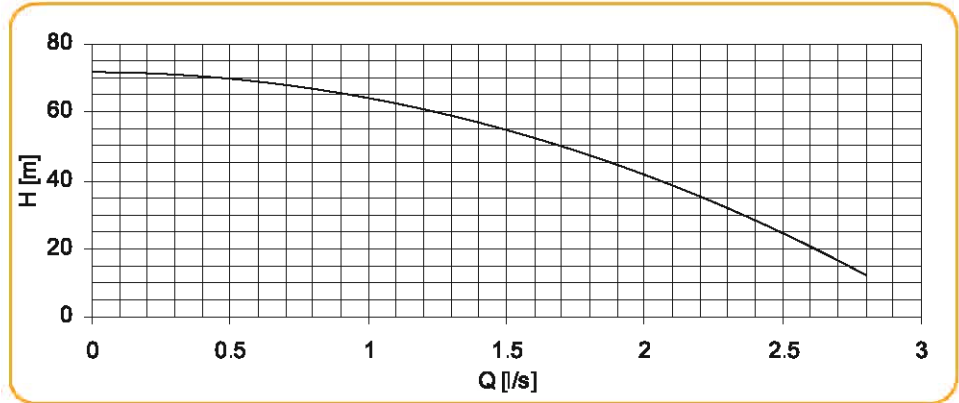

Power Input

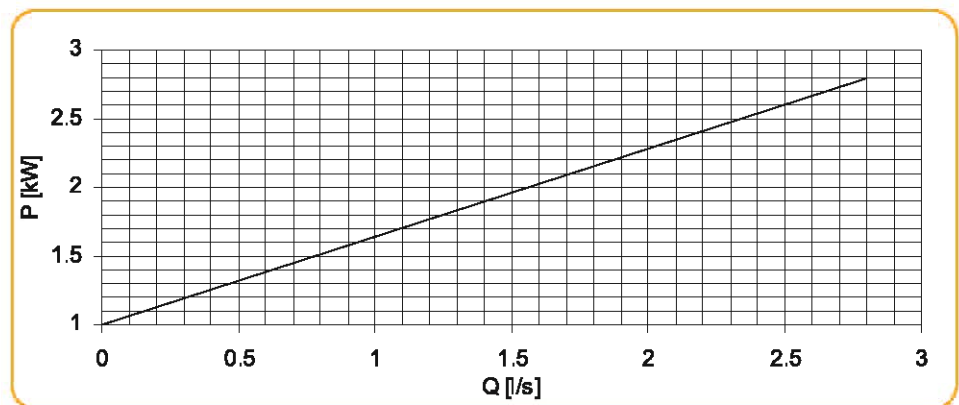

Efficiency

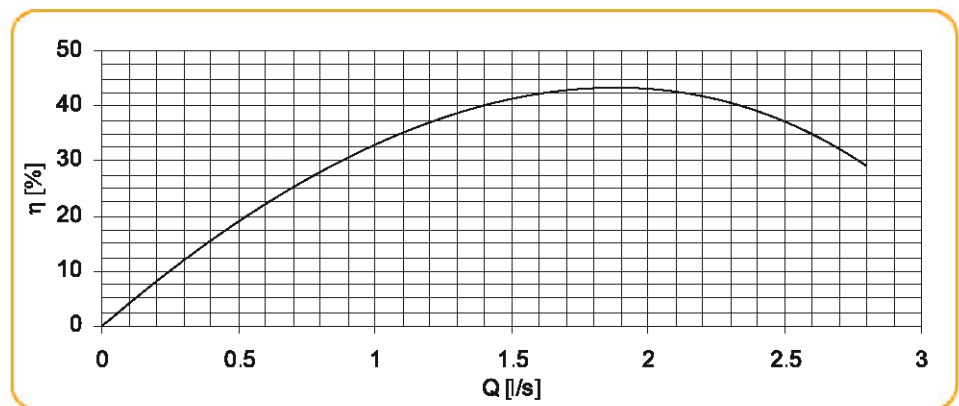

Pump performance curves

Total
Differential
Head

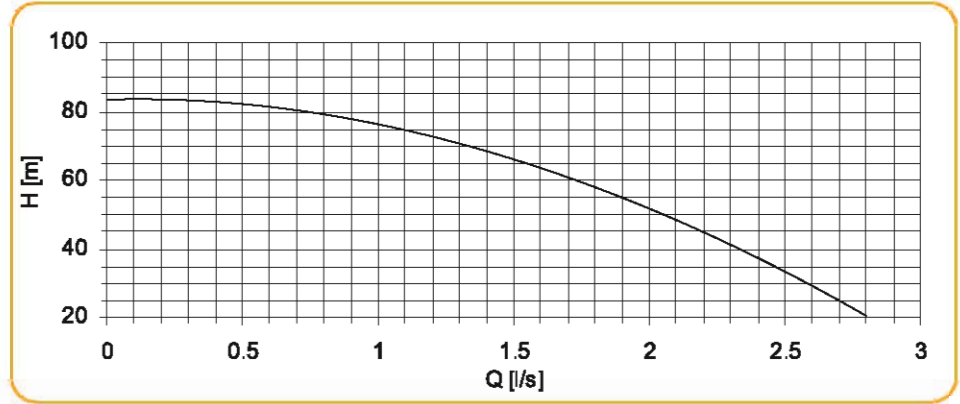

Power Input

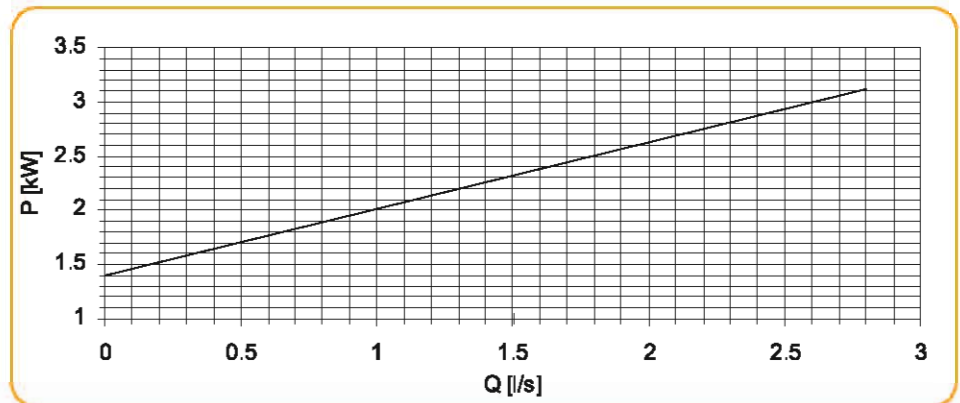

Efficiency

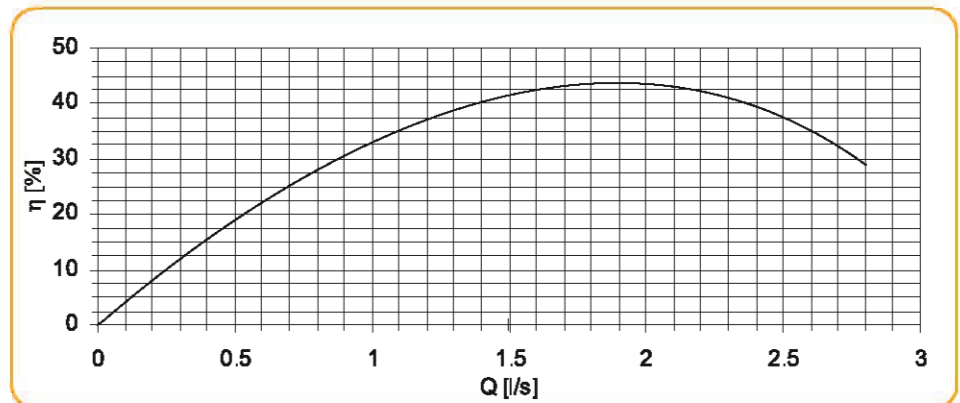

Pump performance curves

BCP10-8
n =2900 (rpm)

Total
Differential
Head

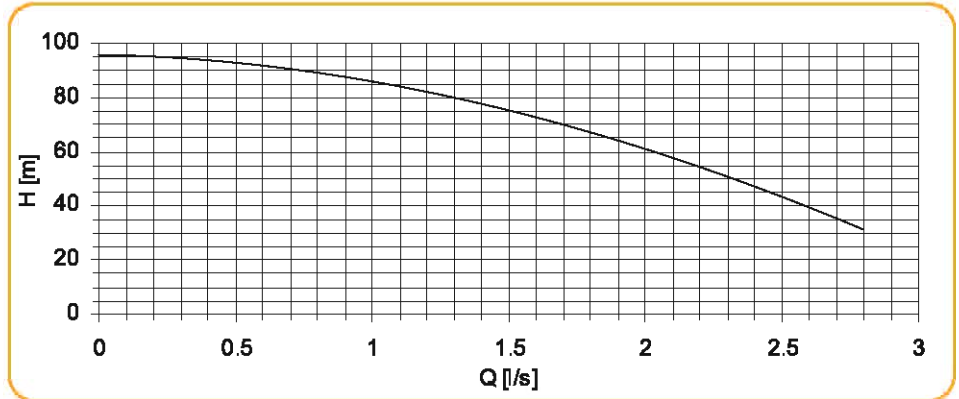

Power Input

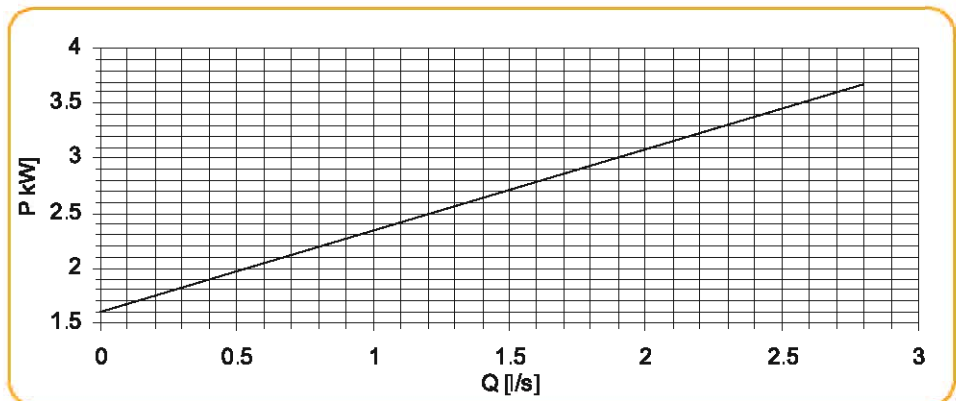

Efficiency

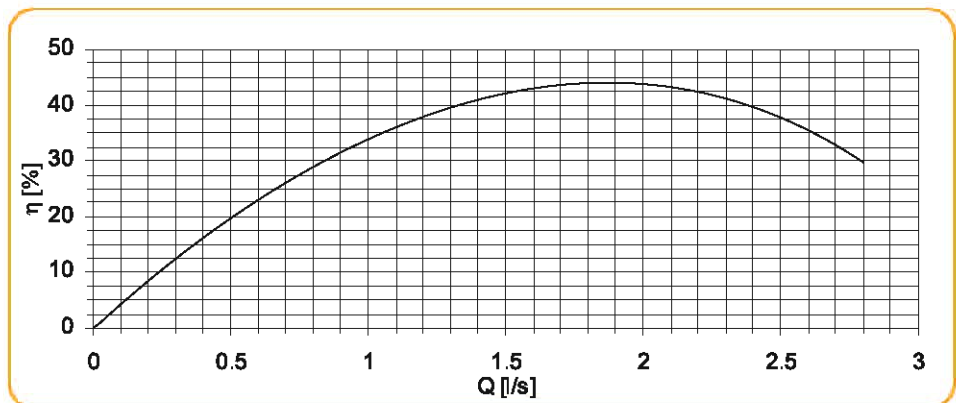

Pump performance curves

Total
Differential
Head

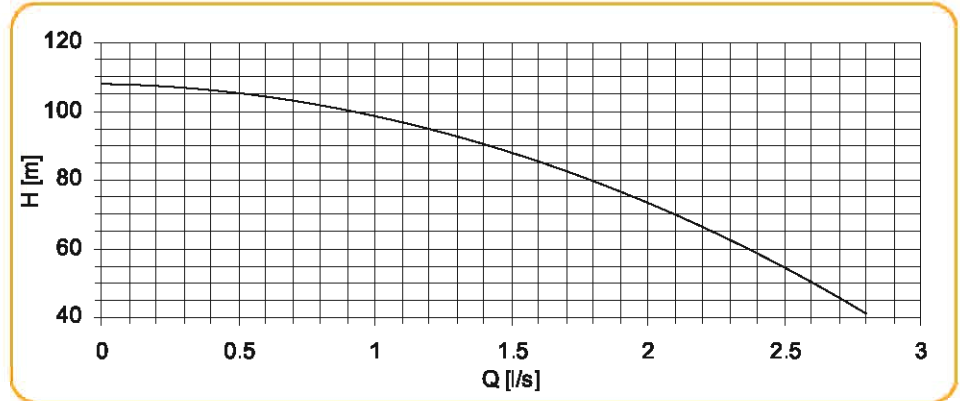

Power Input

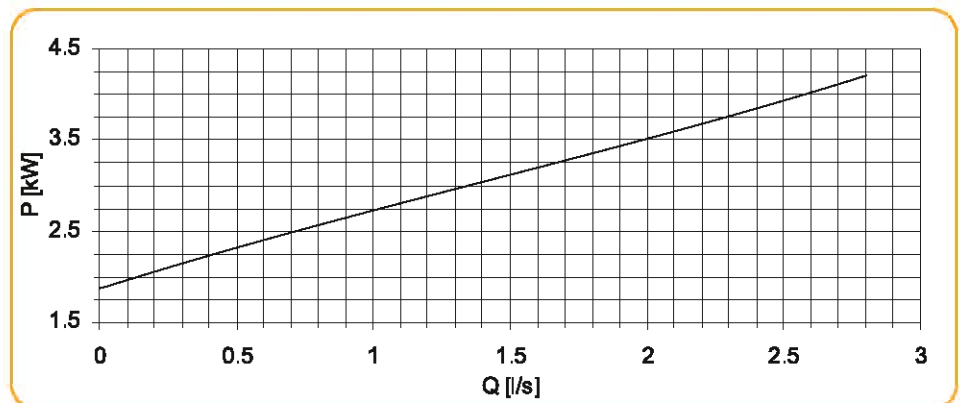

Efficiency

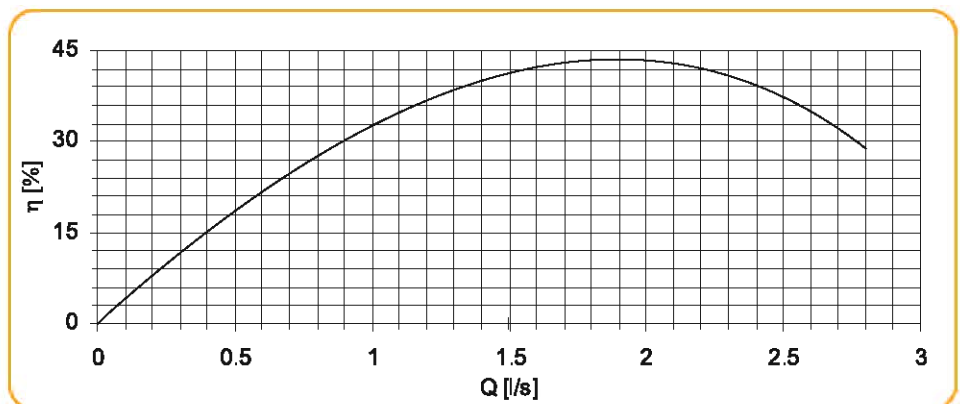

Pump performance curves

BCP10-10
n =2900 (rpm)

Total
Differential
Head

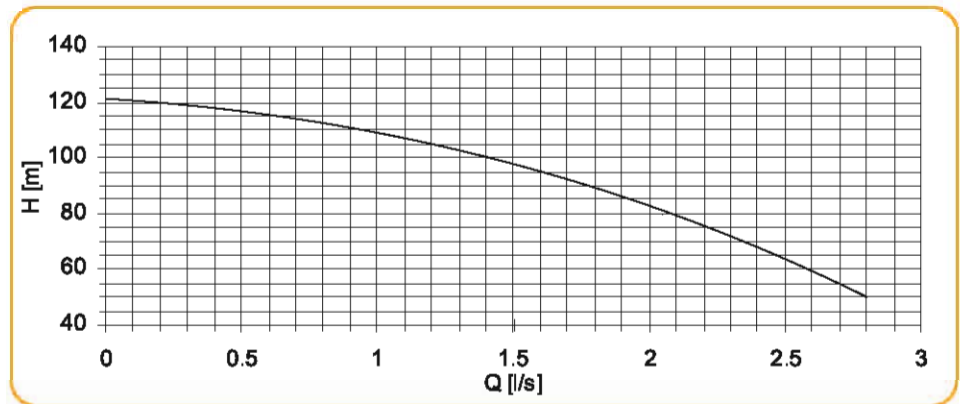

Power Input

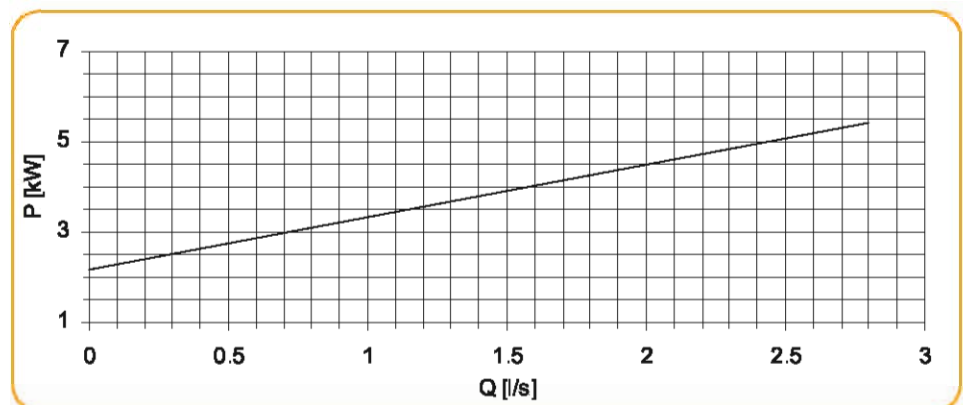

Efficiency

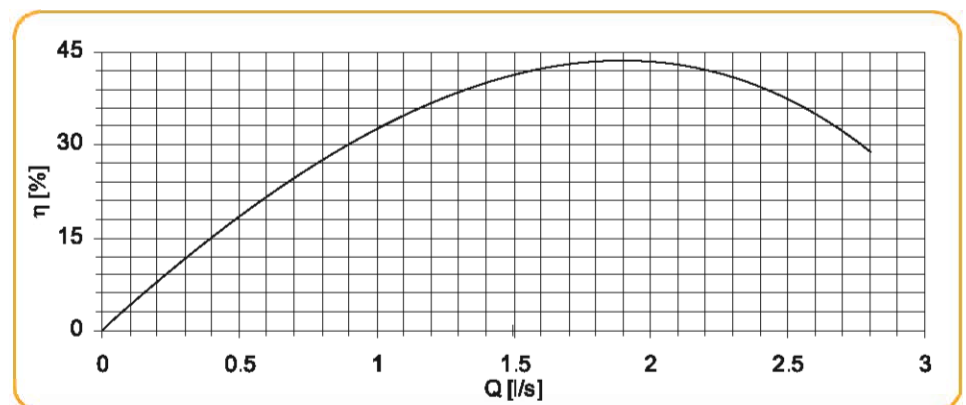

Pump performance curves

Total Differential Head

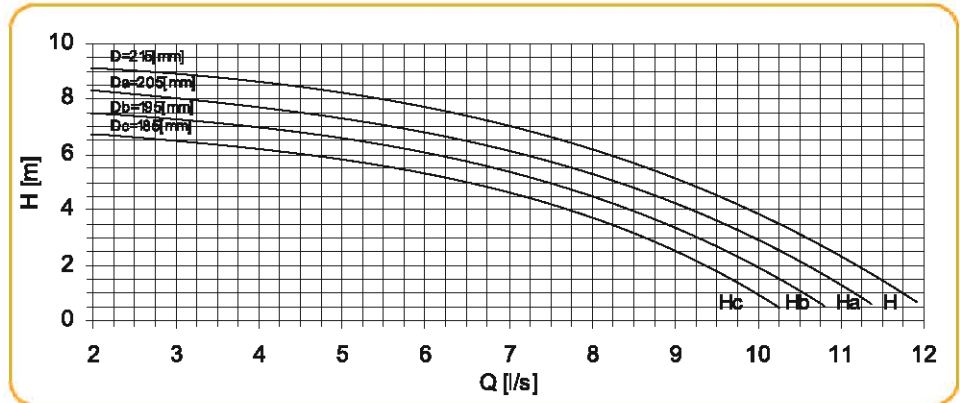

Power Input

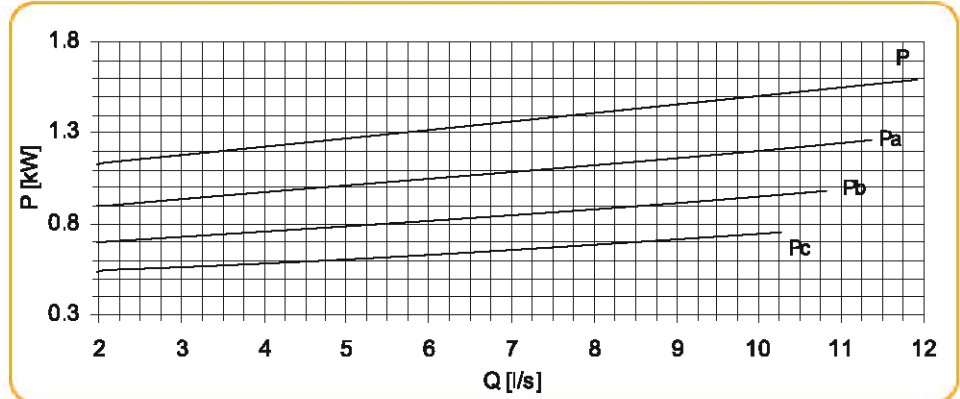

Efficiency

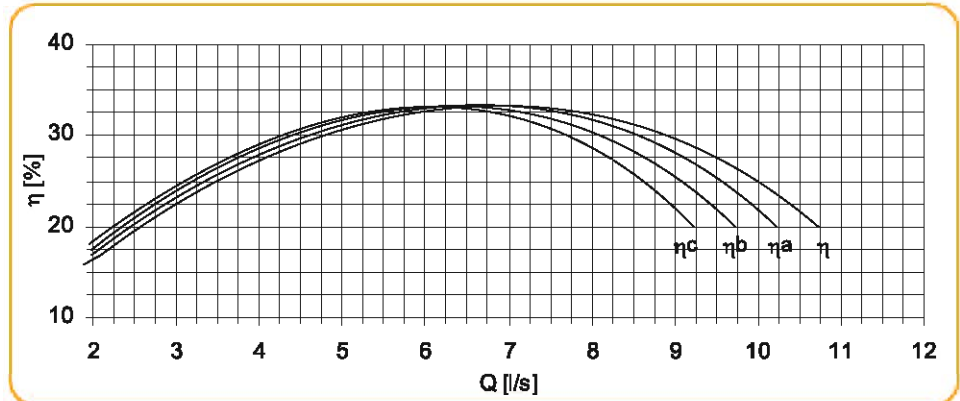

Net Positive Suction Head

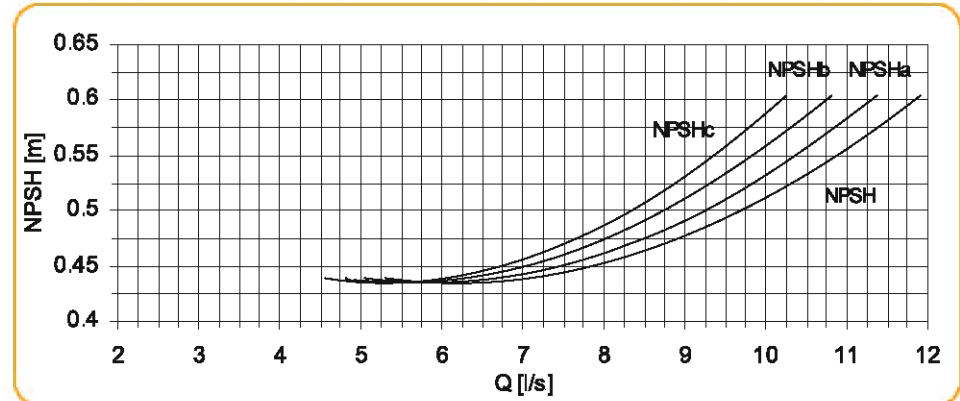

Pump performance curves

Total
Differential
Head

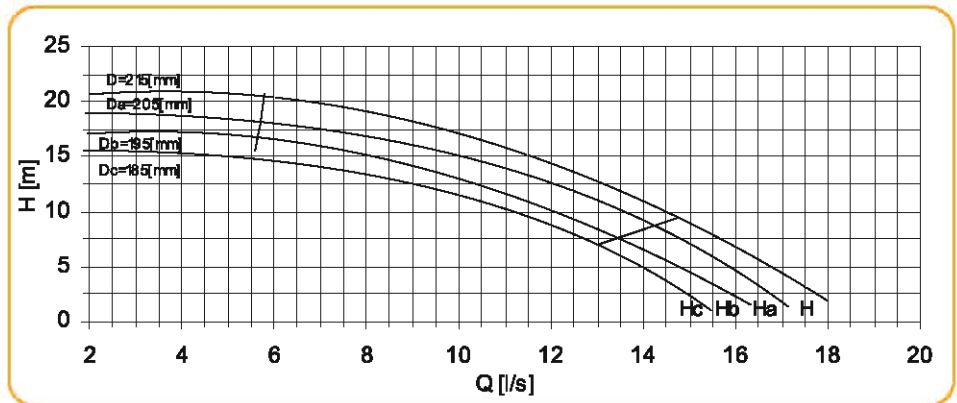

Power Input

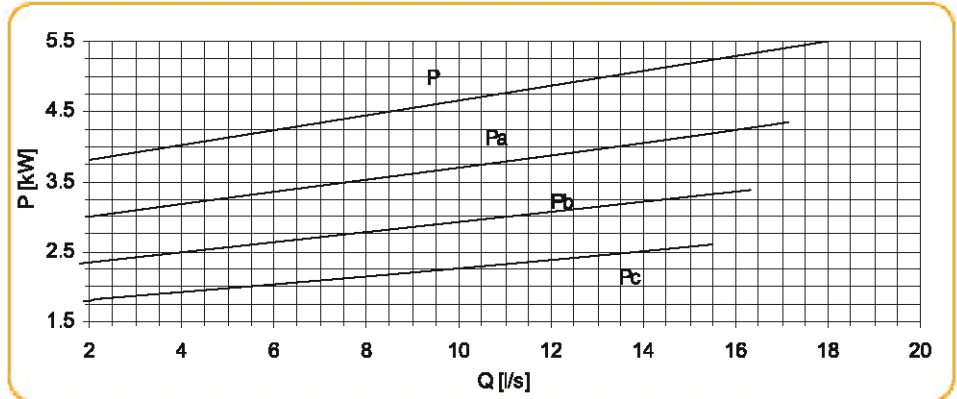

Efficiency

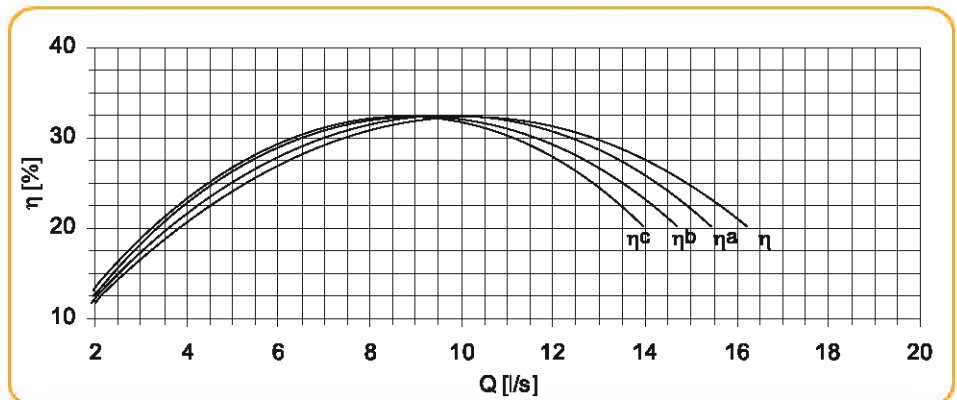

Net Positive
Suction Head

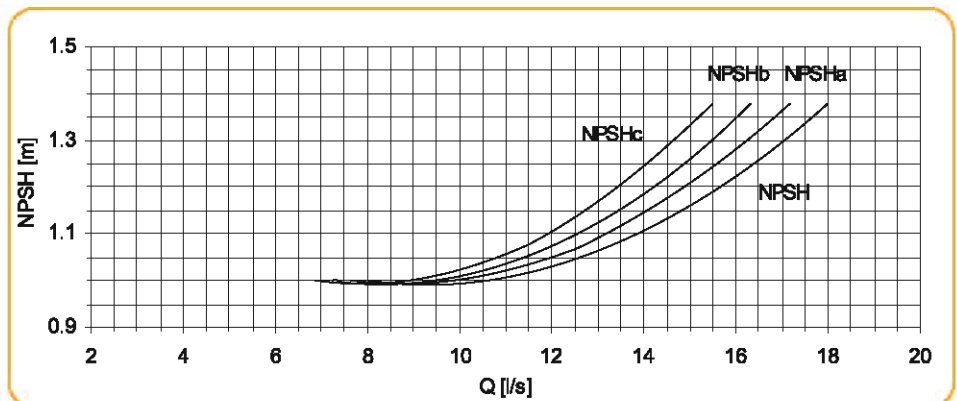

Pump performance curves

Total
Differential
Head

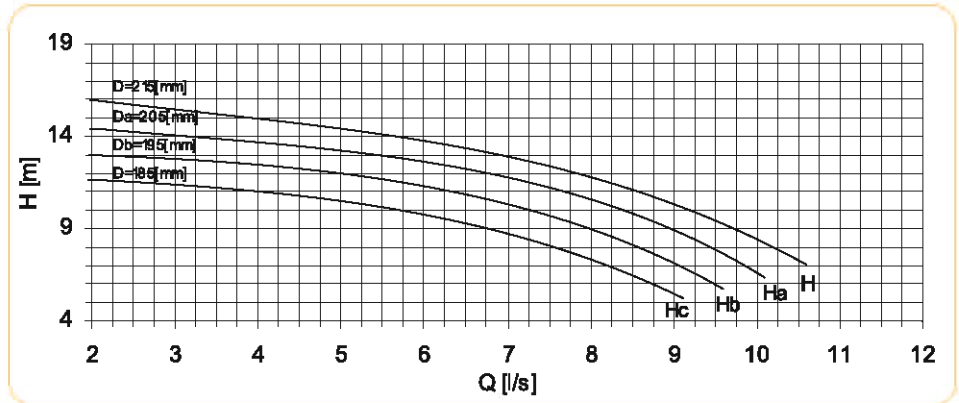

Power Input

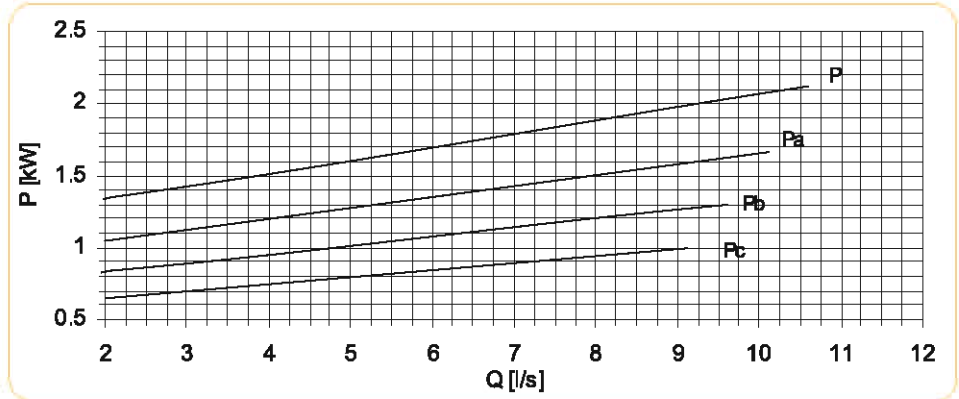

Efficiency

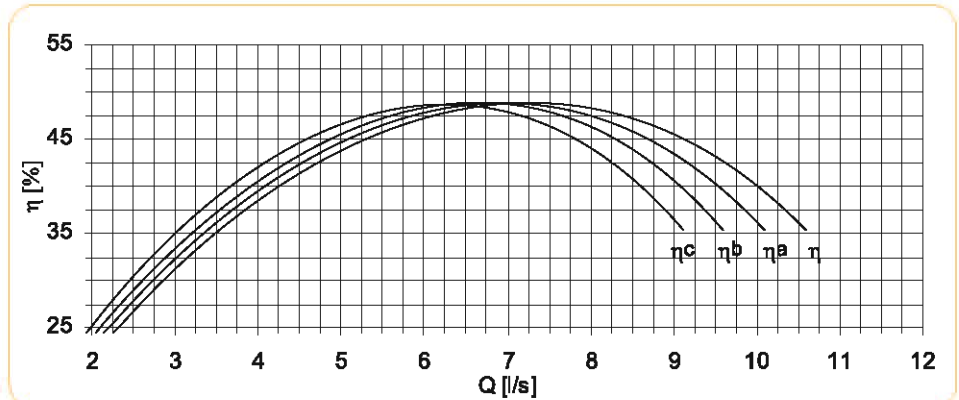

Net Positive
Suction Head

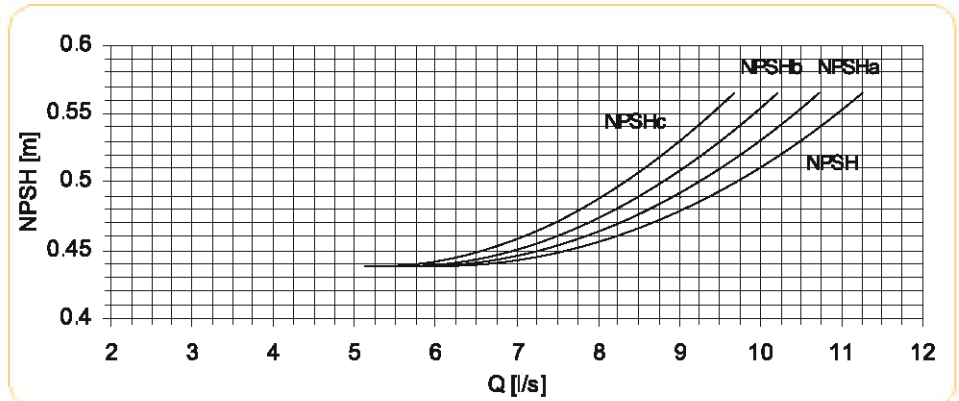

Pump performance curves

Total
Differential
Head

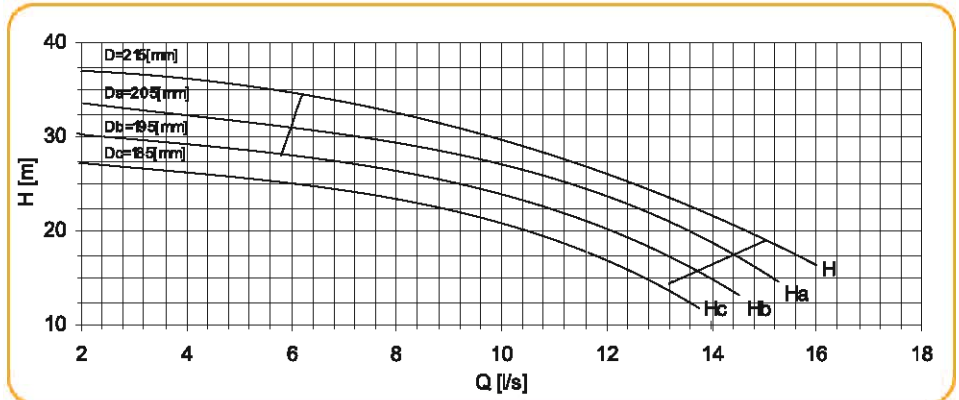

Power Input

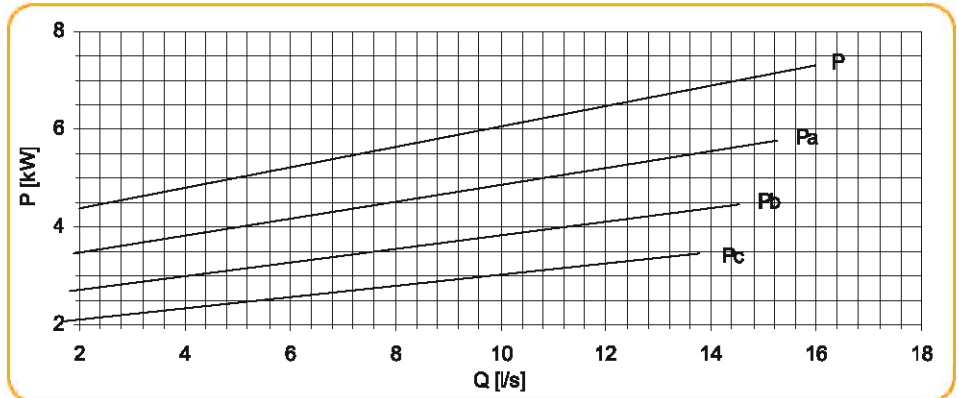

Efficiency

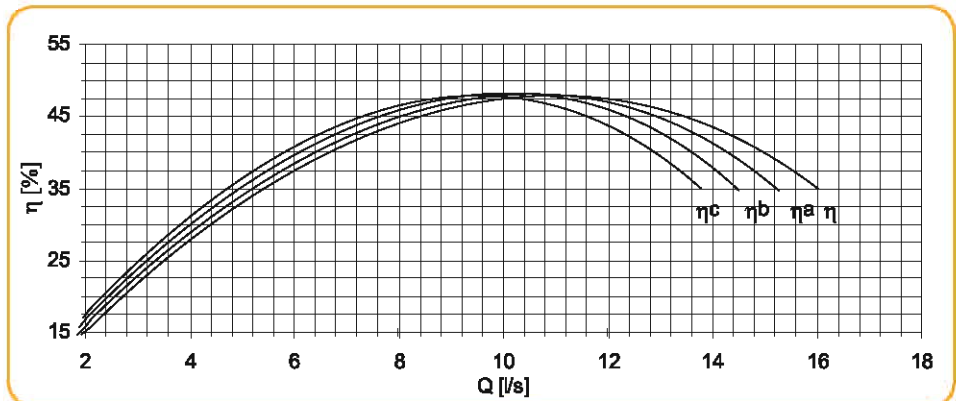

Net Positive
Suction Head

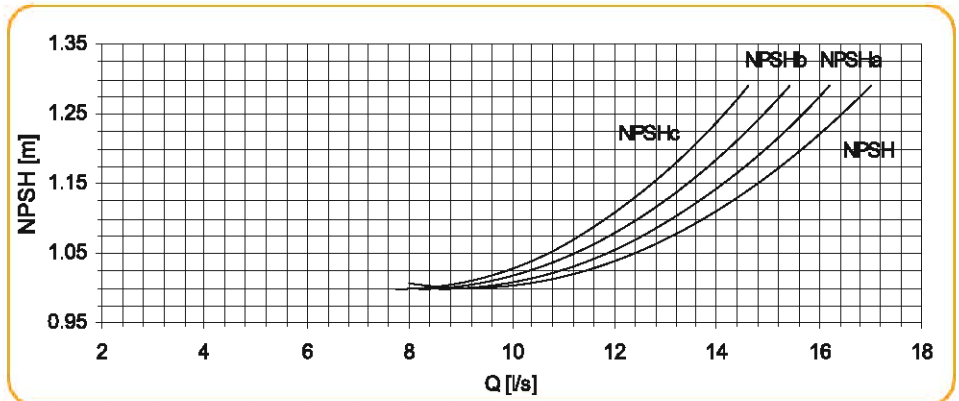

Pump performance curves

Total Differential Head

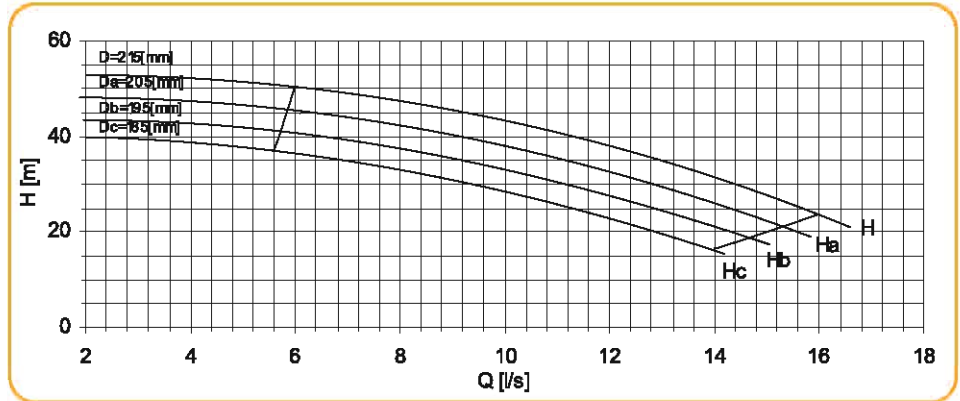

Power Input

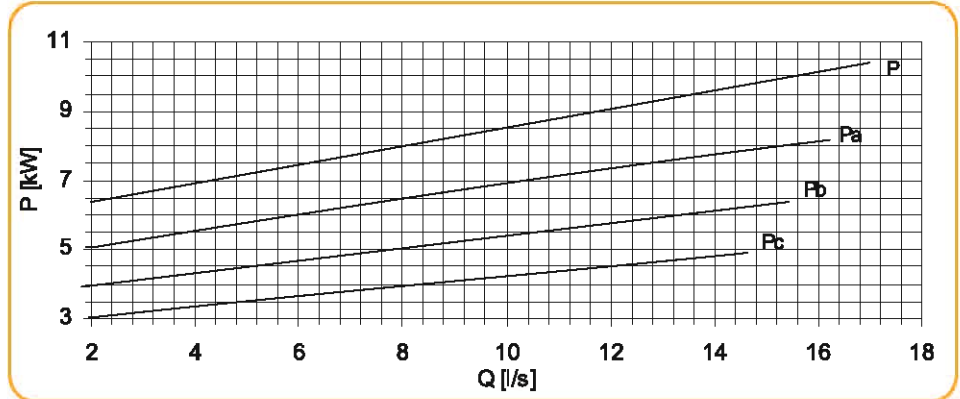

Efficiency

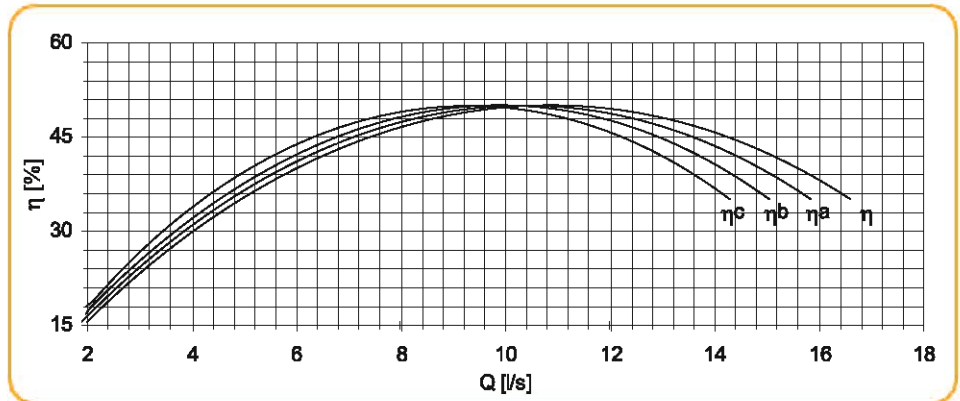

Net Positive Suction Head

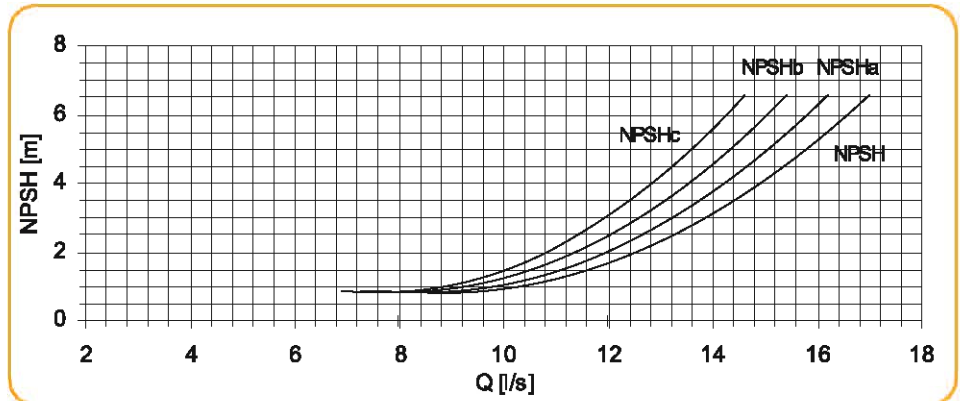

Pump performance curves

Total
Differential
Head

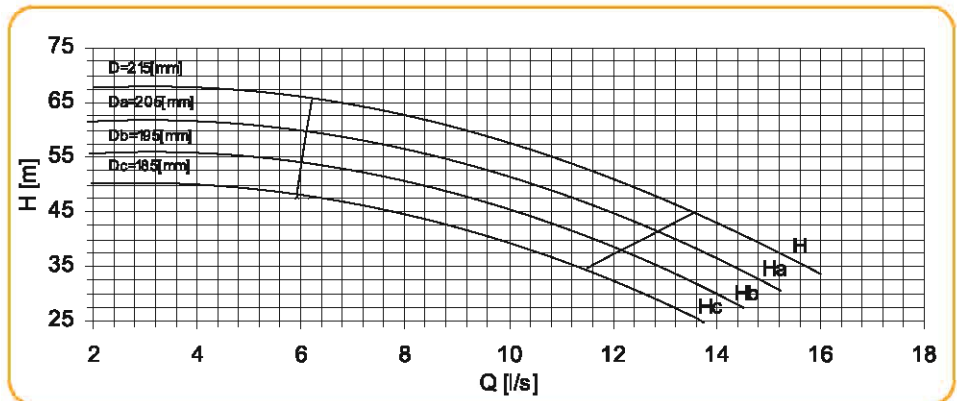

Power Input

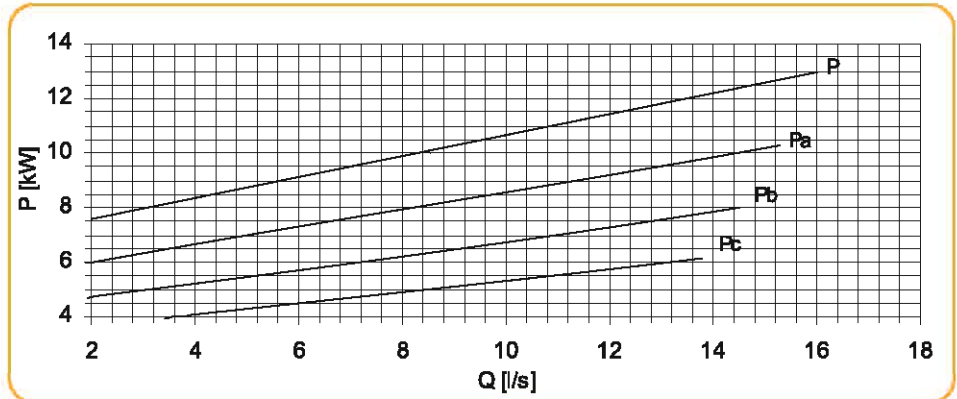

Efficiency

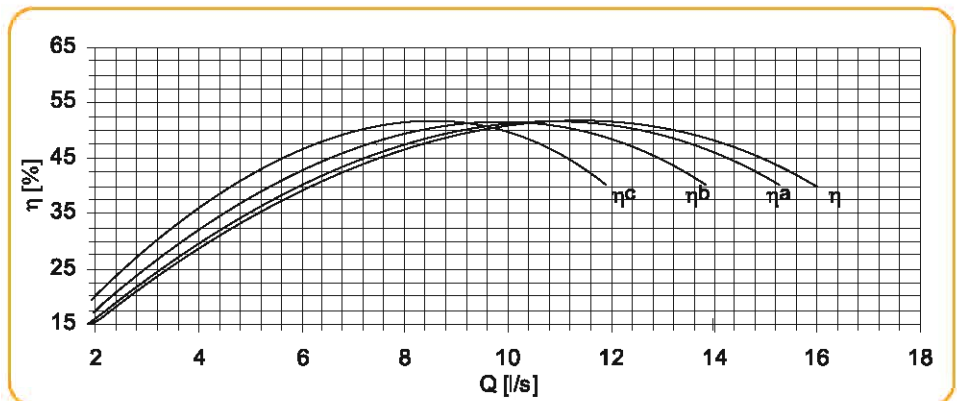

Net Positive
Suction Head

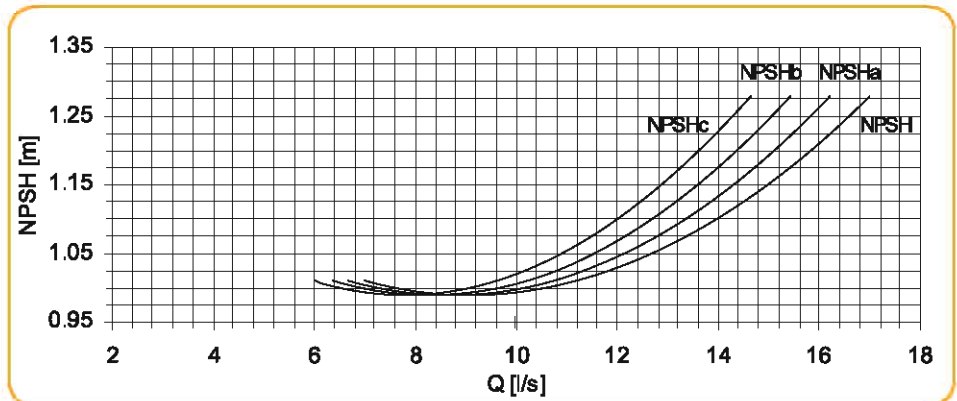

Pump performance curves

Total
Differential
Head

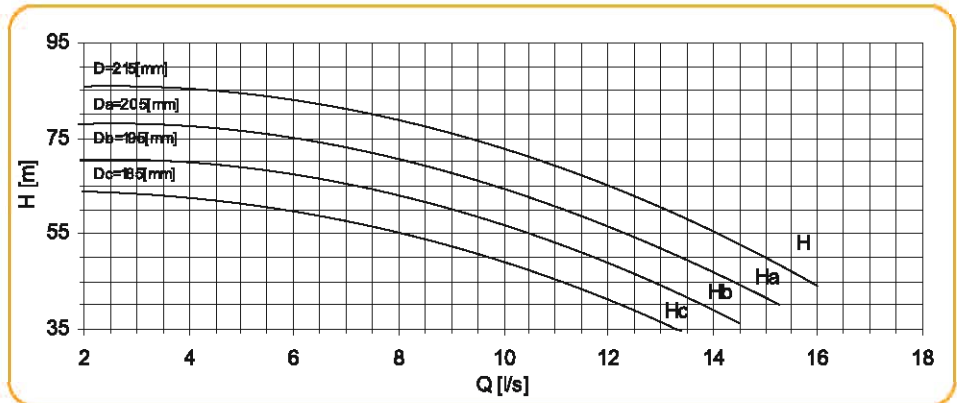

Power Input

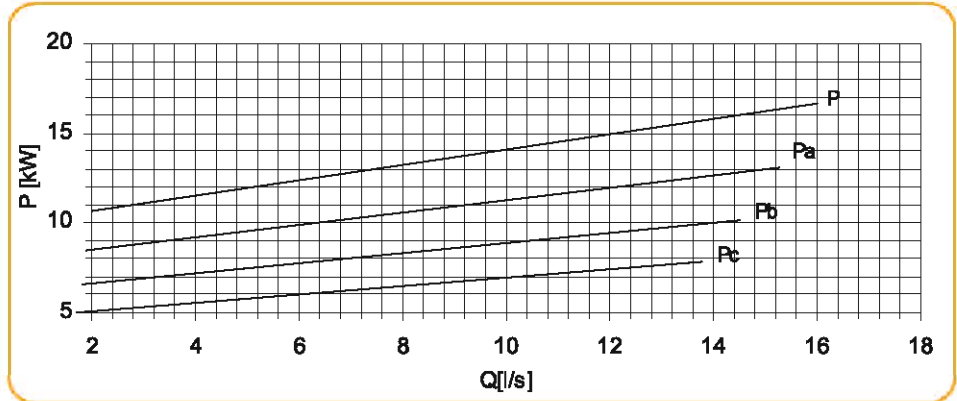

Efficiency

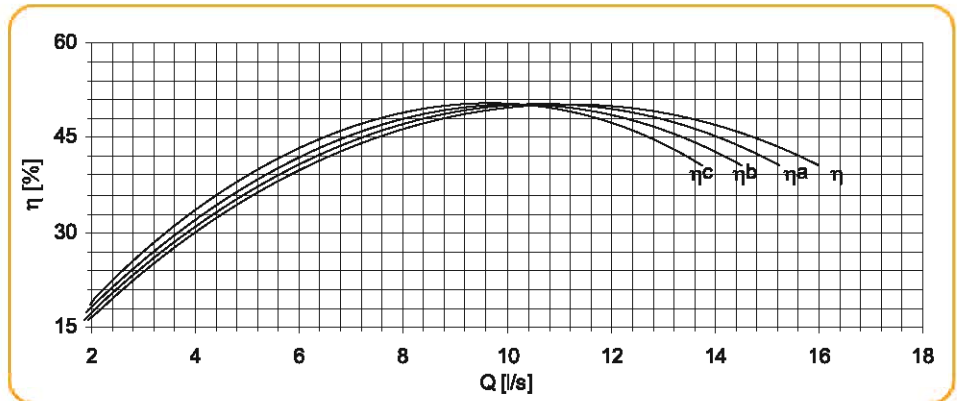

Net Positive
Suction Head

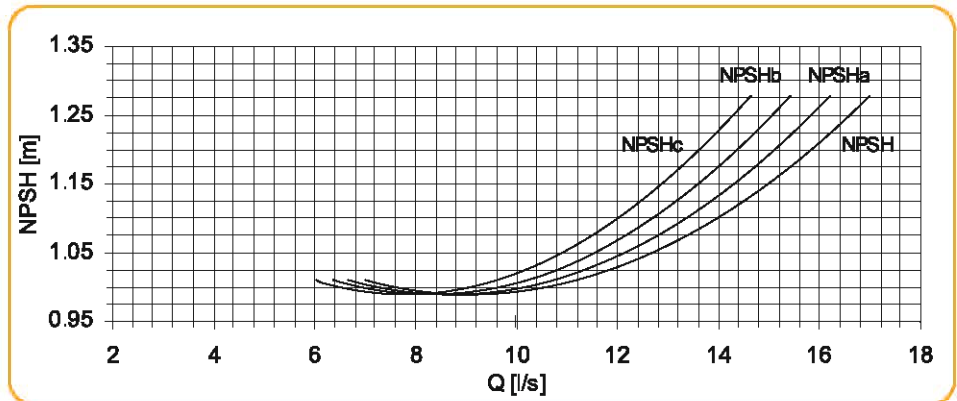

Pump performance curves

Total
Differential
Head

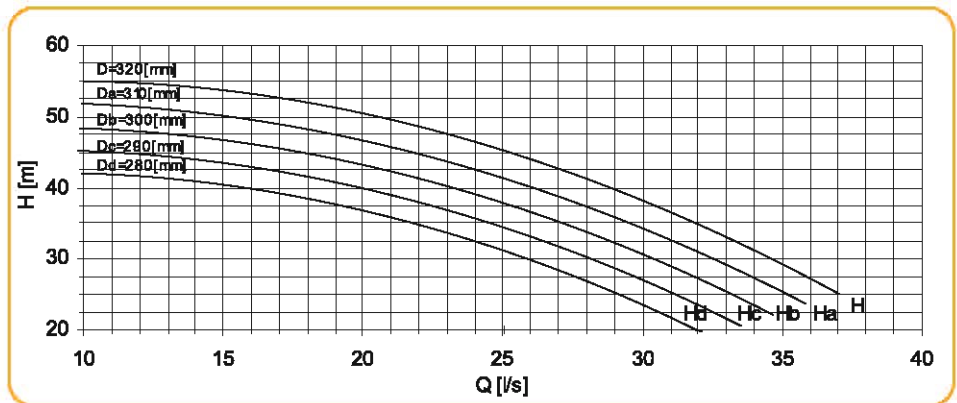

Power Input

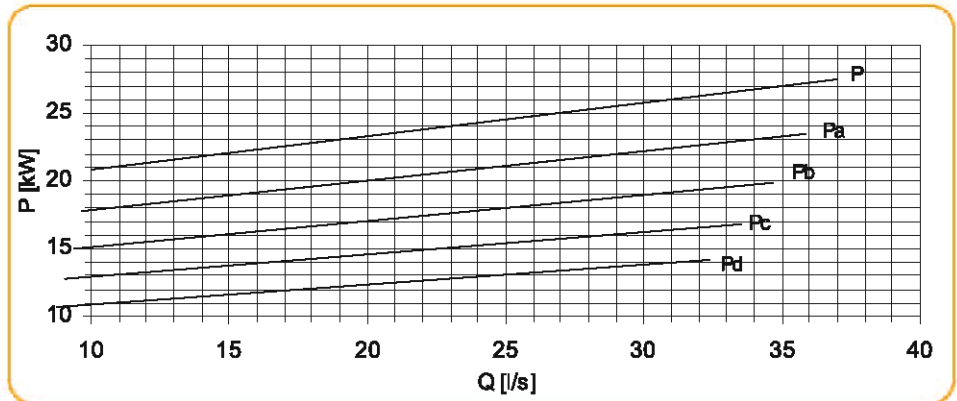

Efficiency

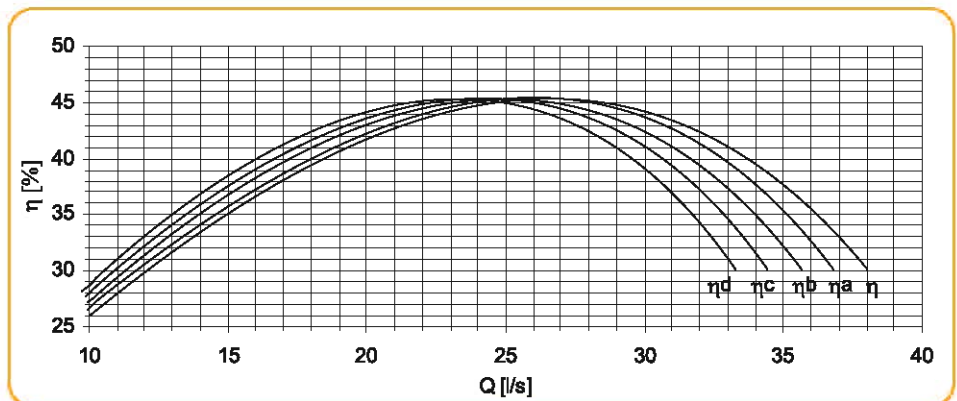

Net Positive
Suction Head

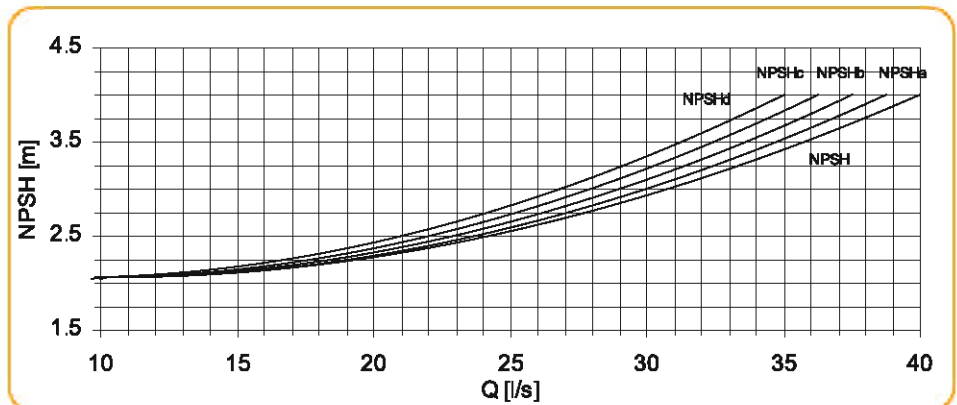

Pump performance curves

Total Differential Head

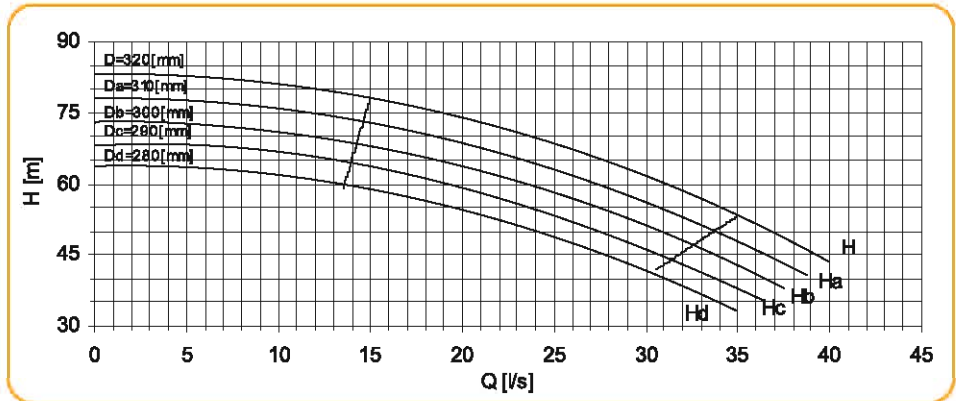

Power Input

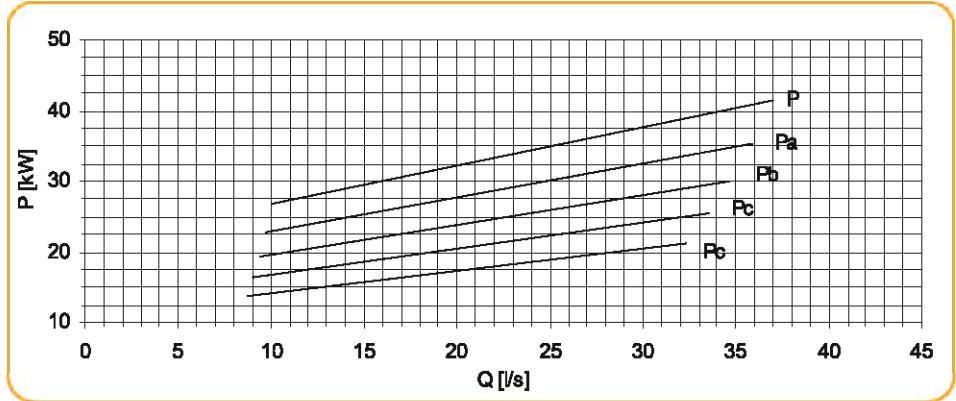

Efficiency

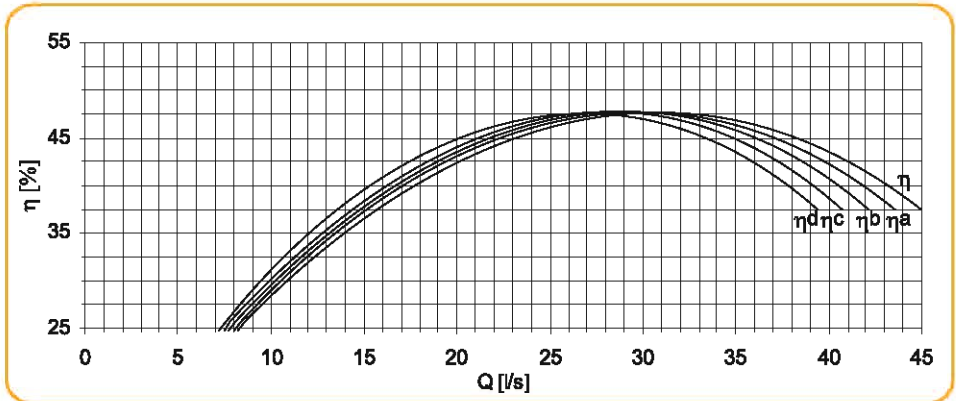

Net Positive Suction Head

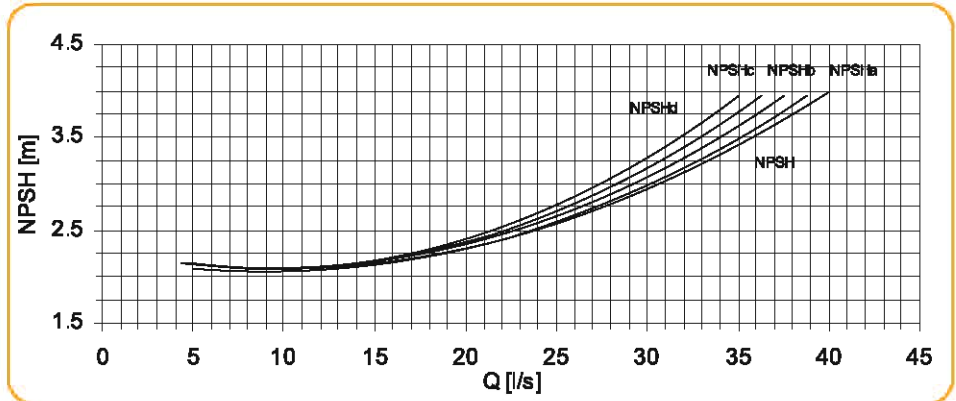

Pump performance curves

Total
Differential
Head

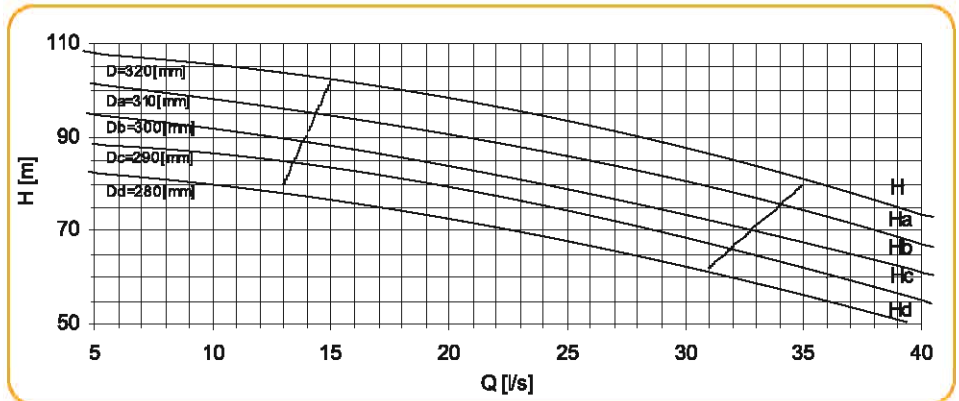

Power Input

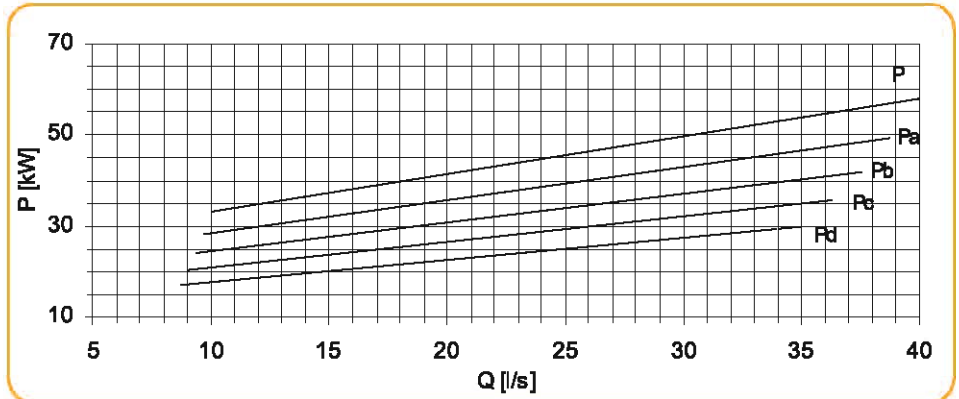

Efficiency

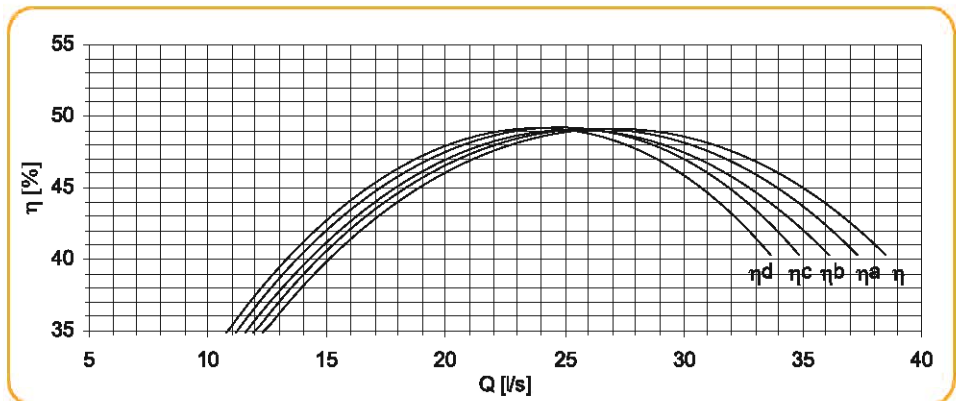

Net Positive
Suction Head

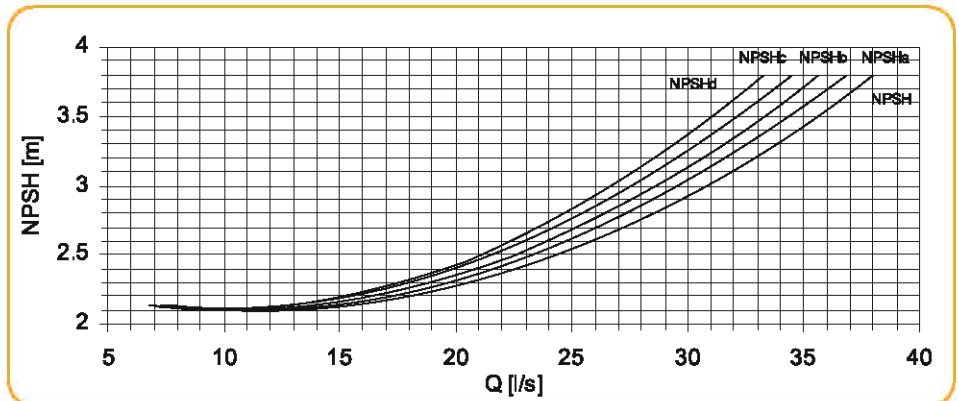

Pump performance curves

Total Differential Head

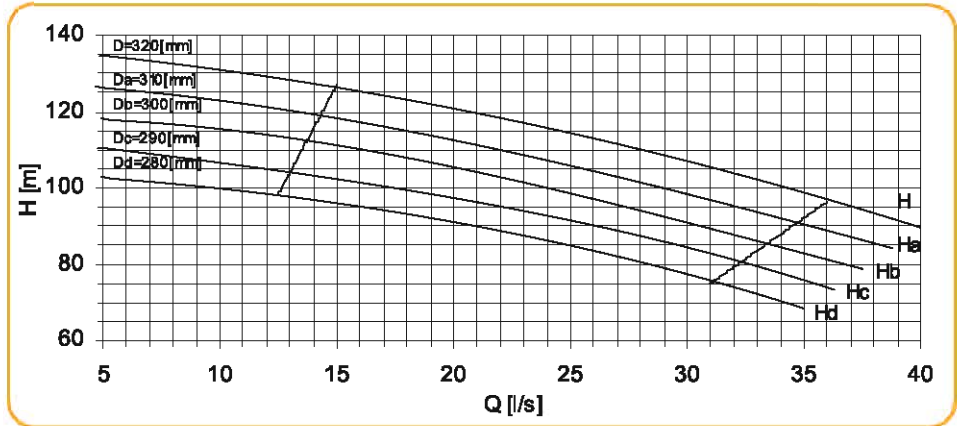

Power Input

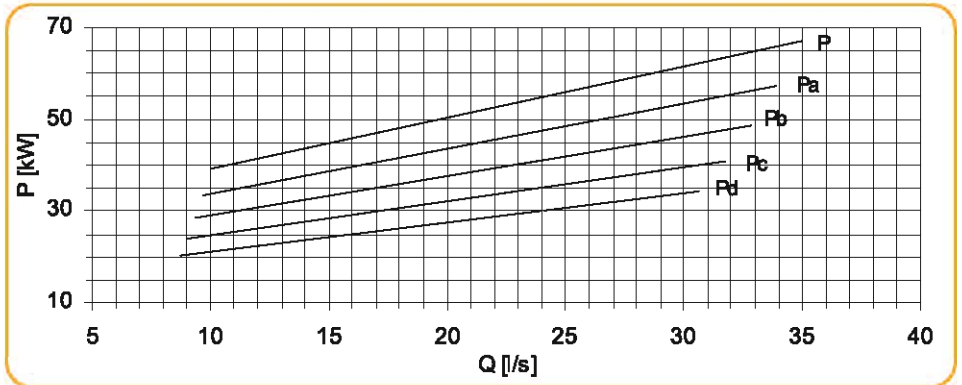

Efficiency

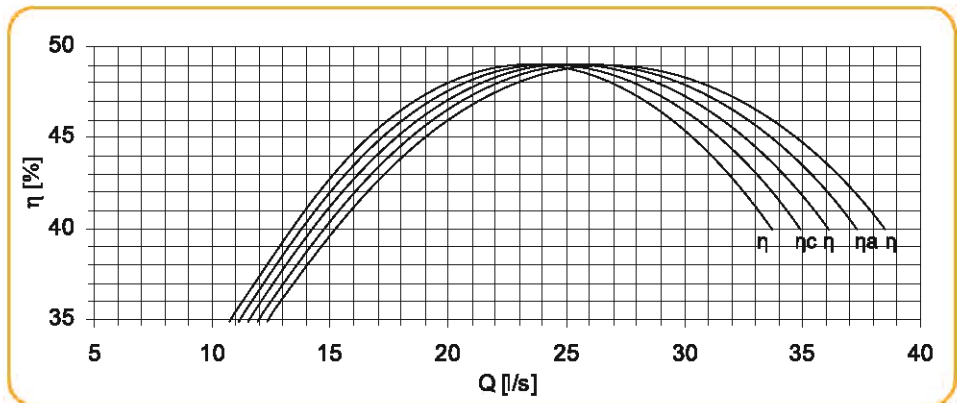

Net Positive Suction Head

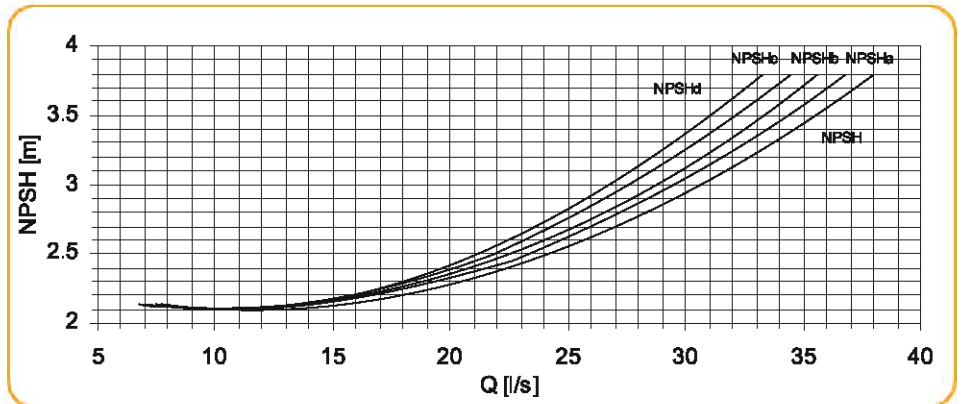

Pump performance curves

Total
Differential
Head

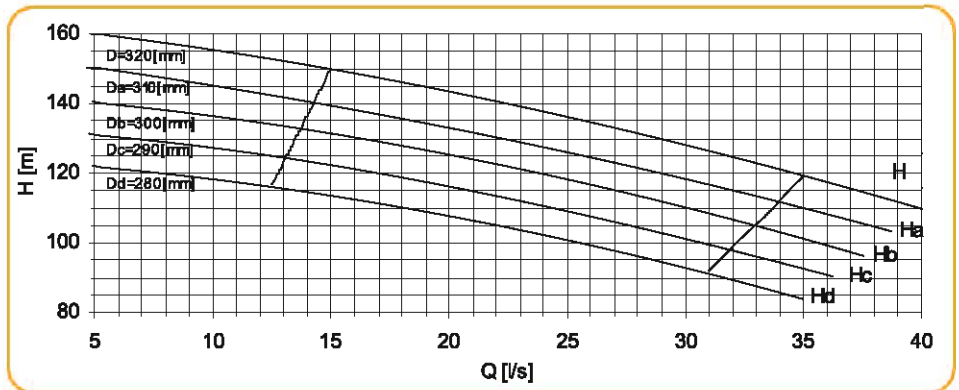

Power Input

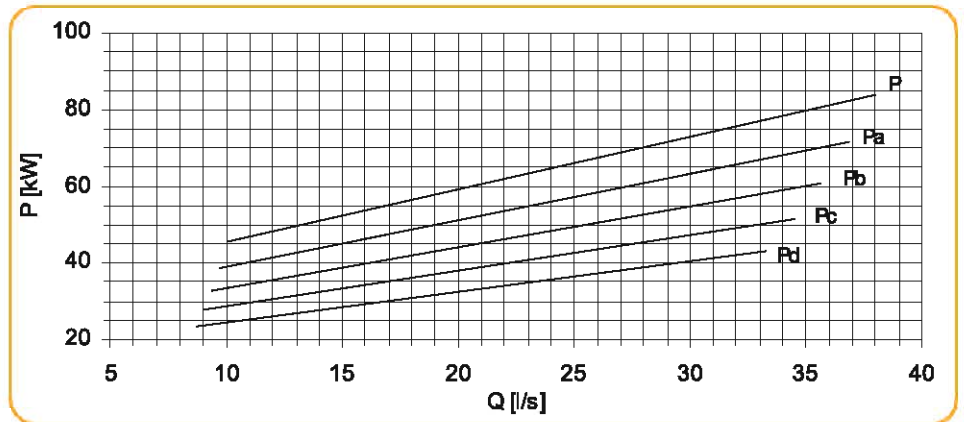

Efficiency

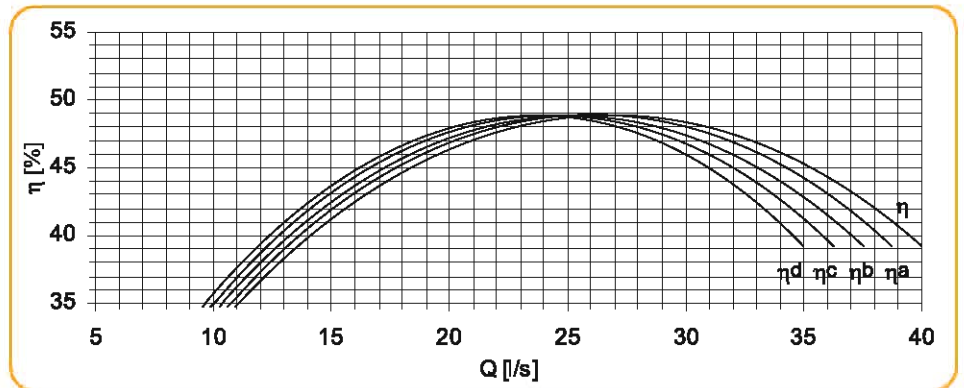

Net Positive
Suction Head

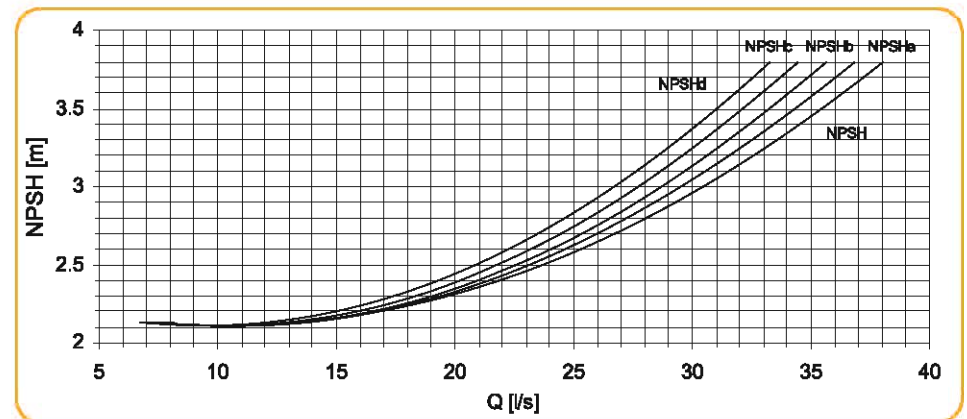

Pump performance curves

Total Differential Head

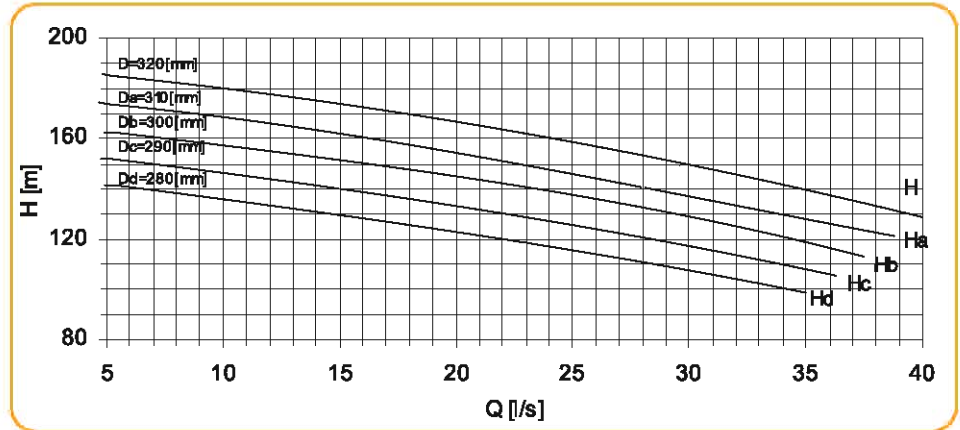

Power Input

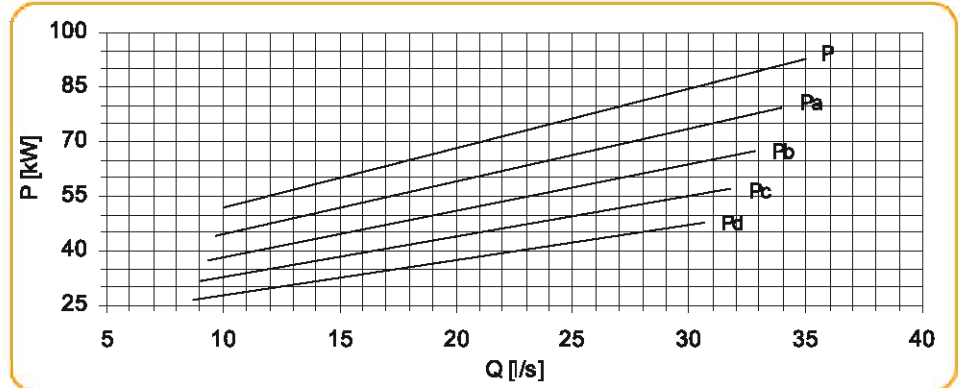

Efficiency

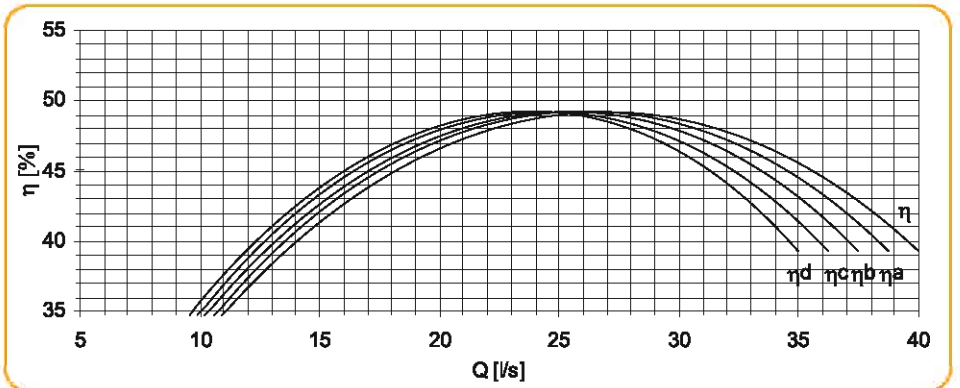

Net Positive Suction Head

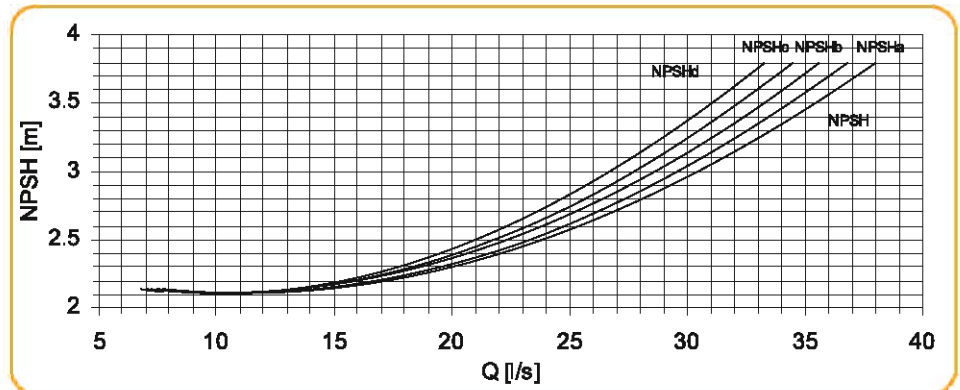

Pump performance curves

Total
Differential
Head

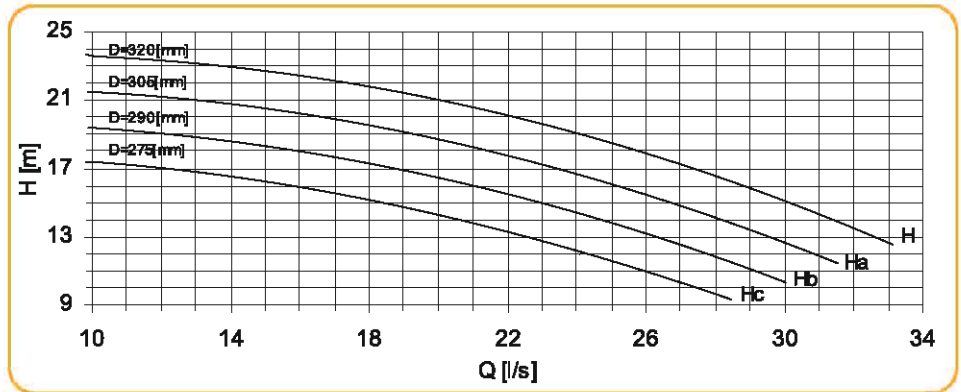

Power Input

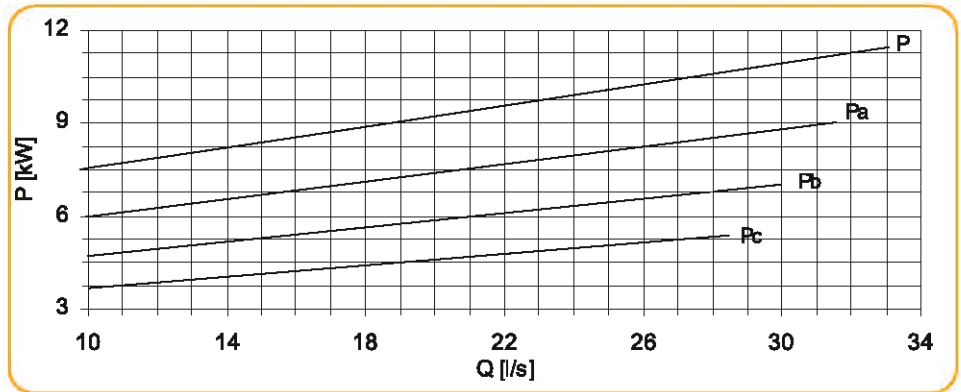

Efficiency

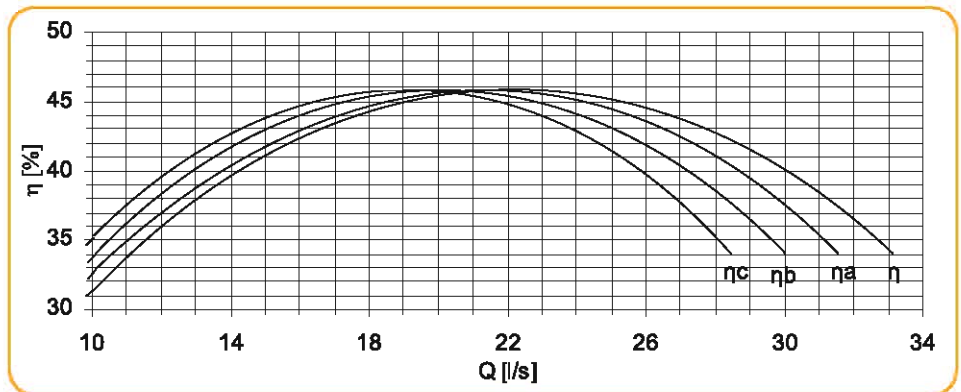

Net Positive
Suction Head

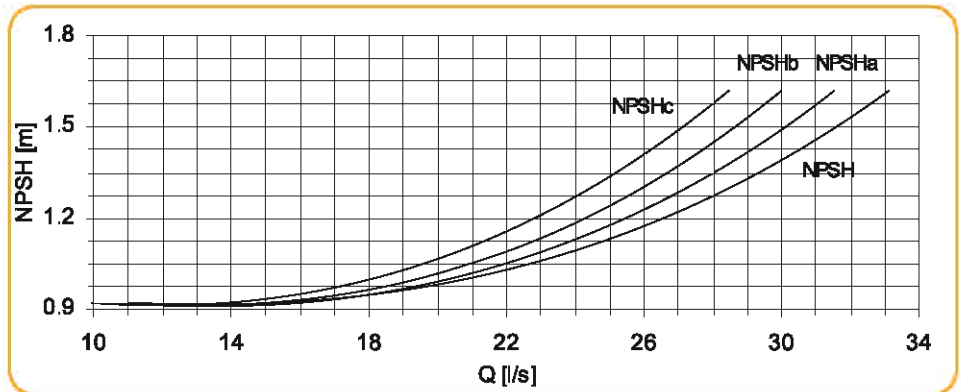

Pump performance curves

Total
Differential
Head

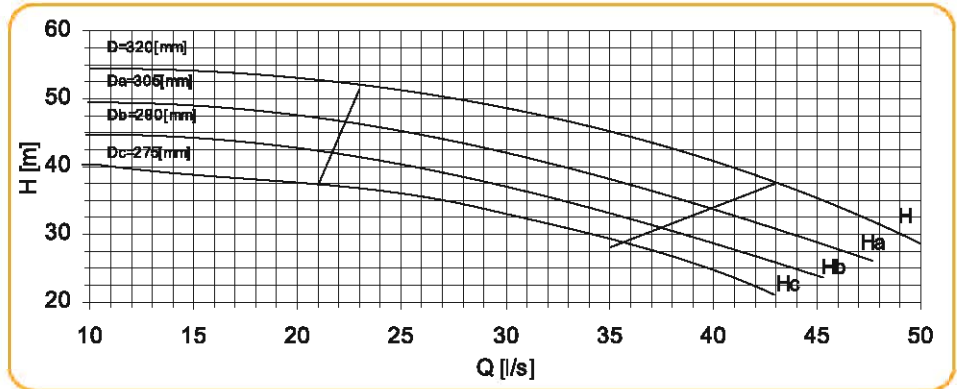

Power Input

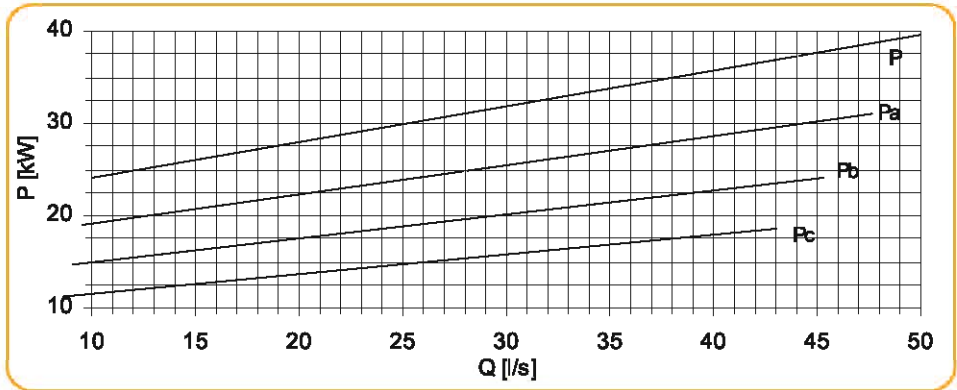

Efficiency

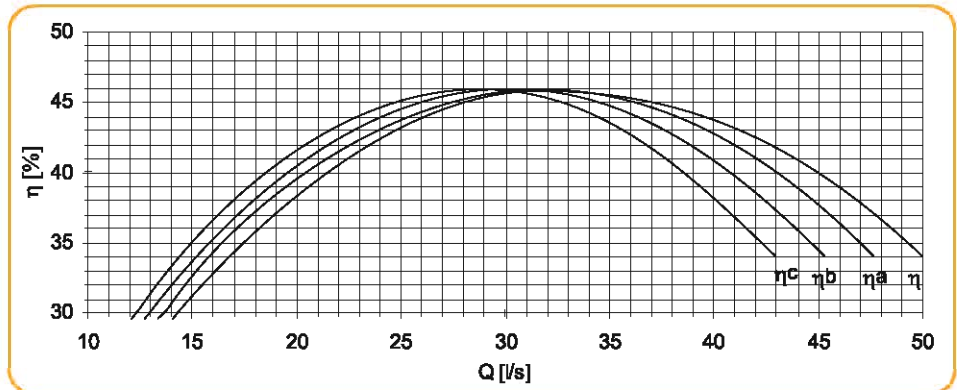

Net Positive
Suction Head

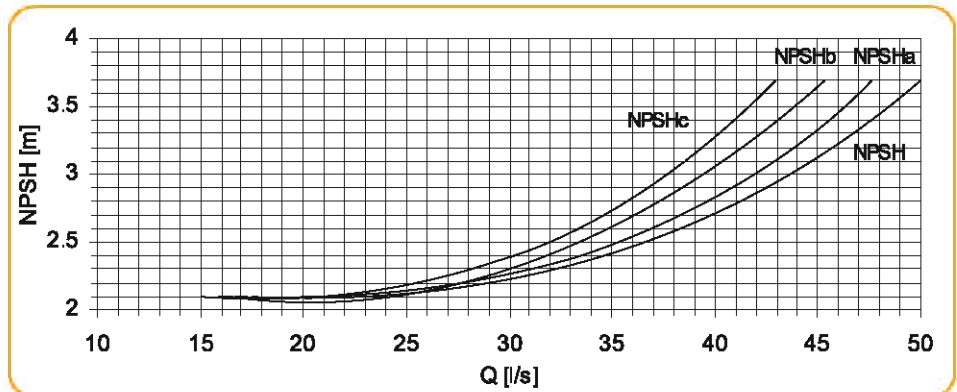

Pump performance curves

Total
Differential
Head

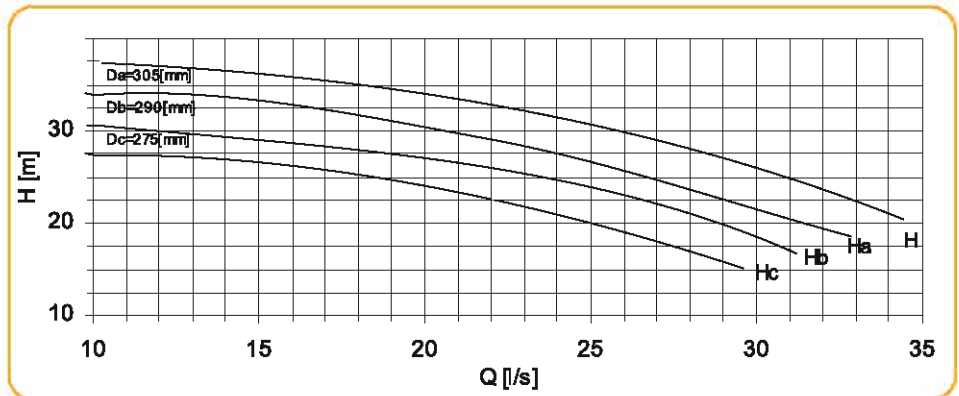

Power Input

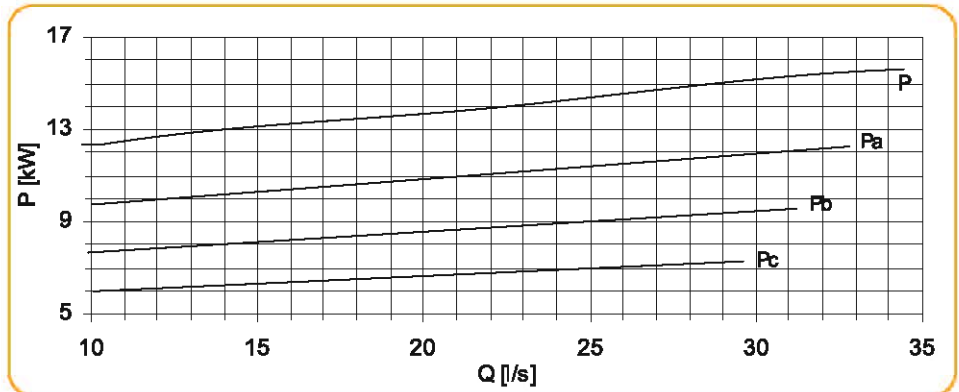

Efficiency

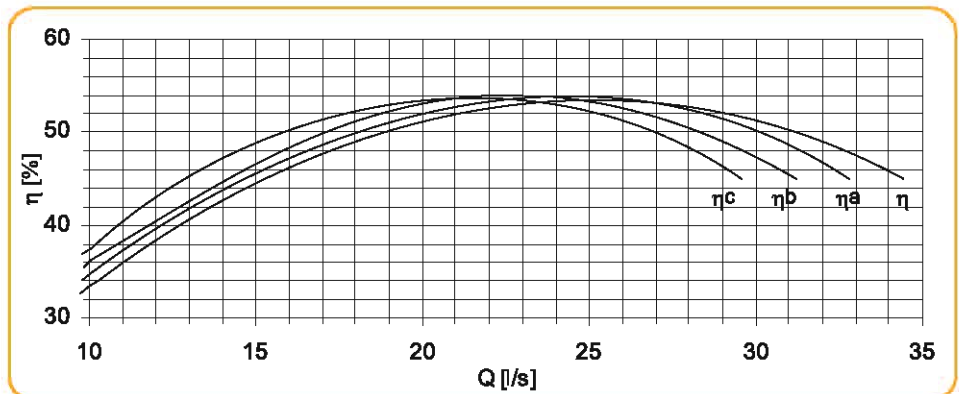

Net Positive
Suction Head

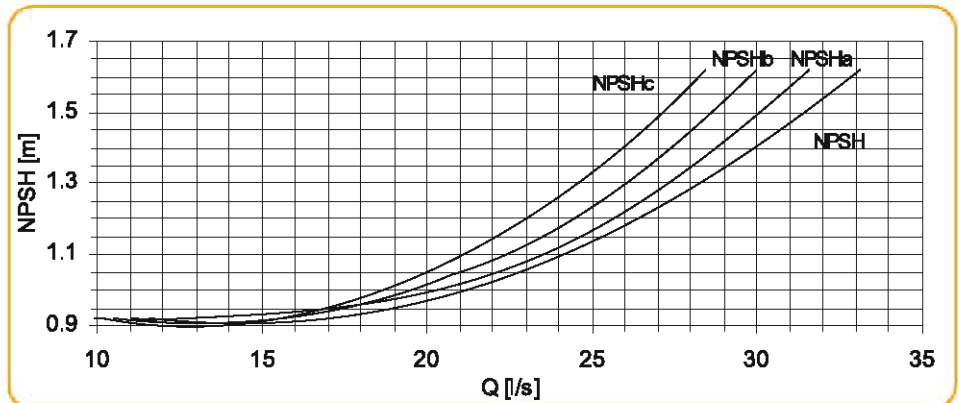

Pump performance curves

Total Differential Head

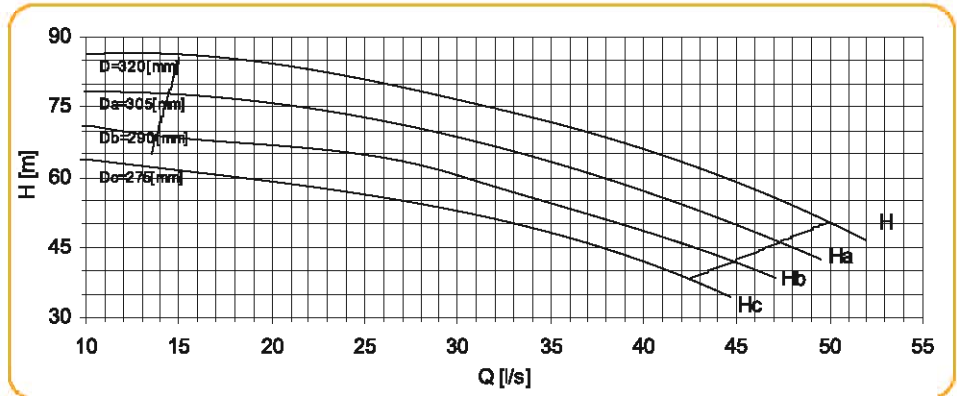

Power Input

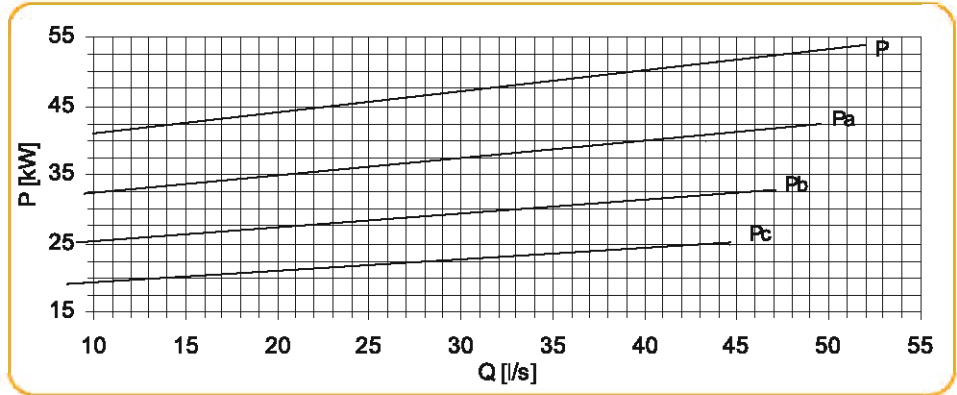

Efficiency

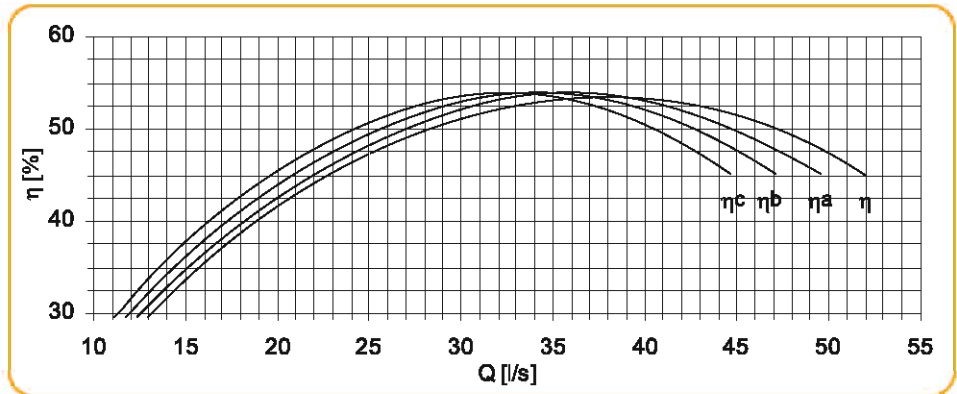

Net Positive Suction Head

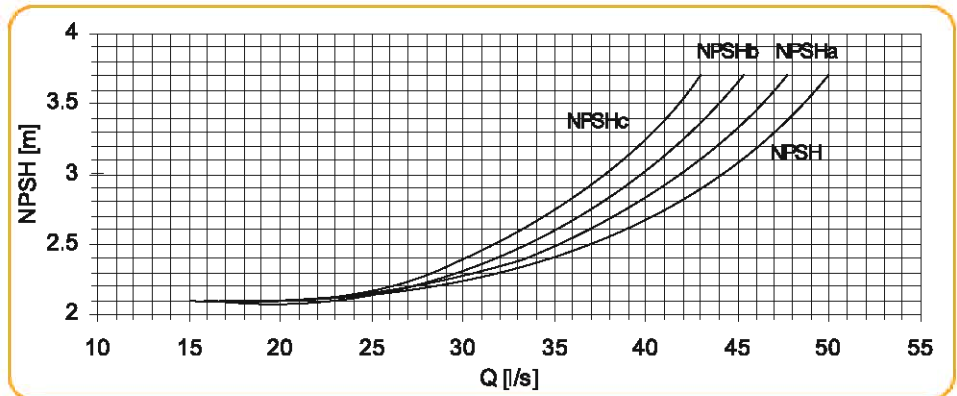

Pump performance curves

Total
Differential
Head

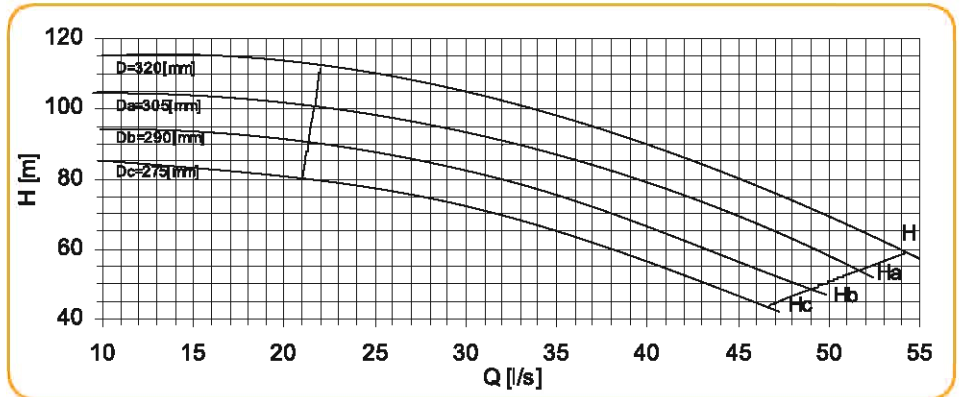

Power Input

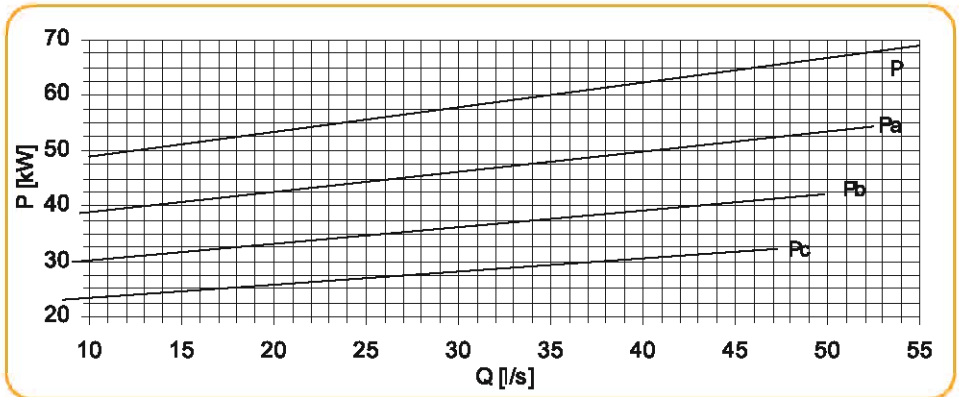

Efficiency

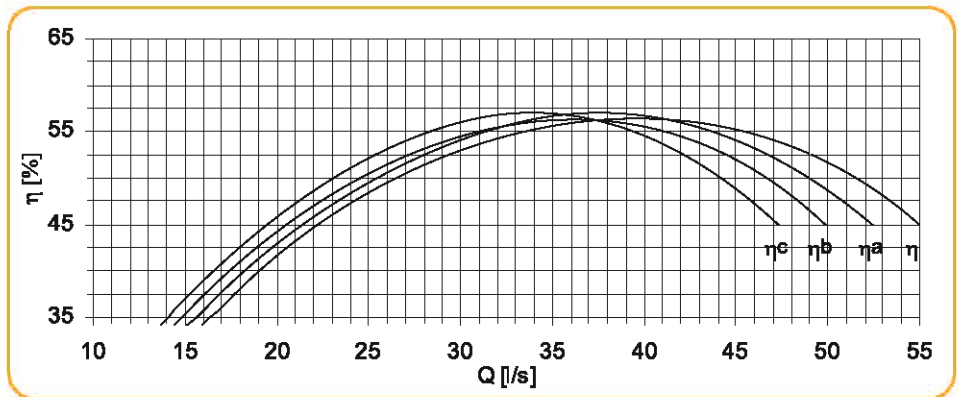

Net Positive
Suction Head

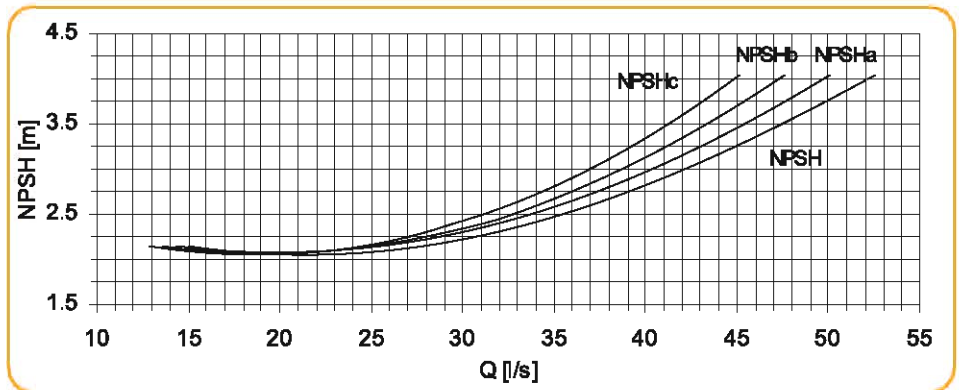

Pump performance curves

Total
Differential
Head

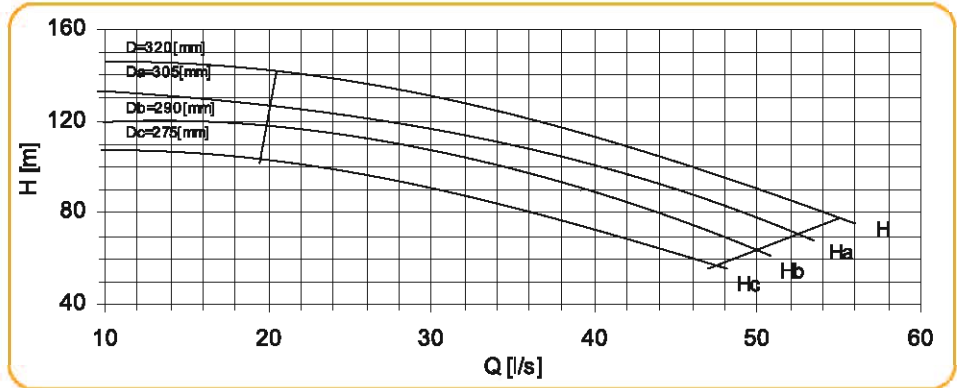

Power Input

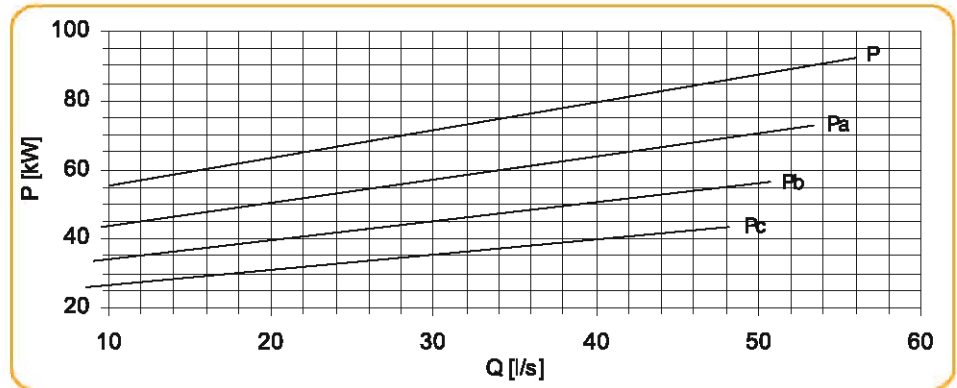

Efficiency

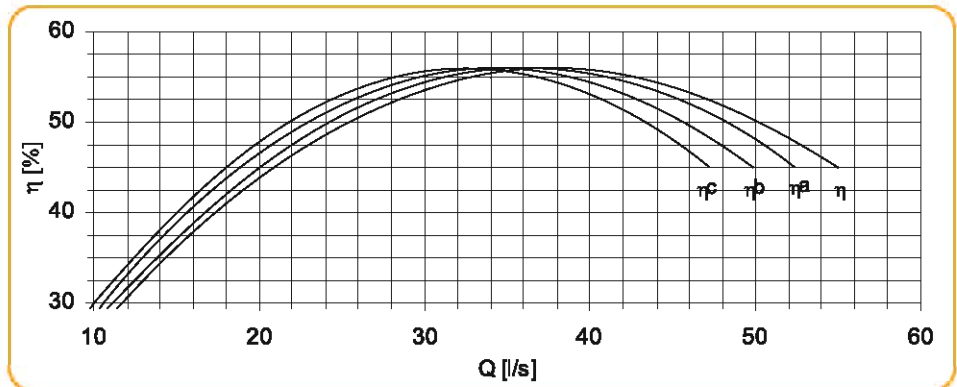

Net Positive
Suction Head

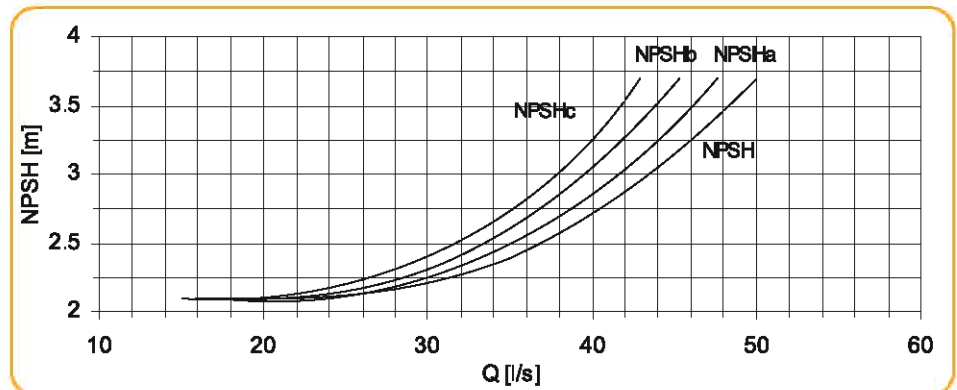

Pump performance curves

Total
Differential
Head

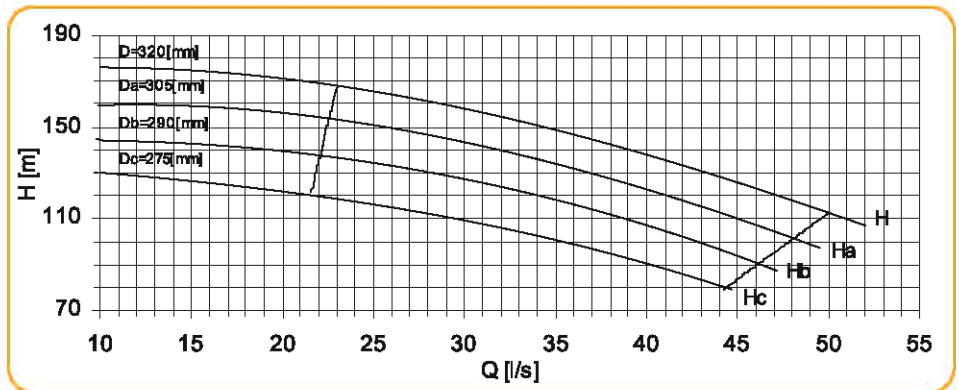

Power Input

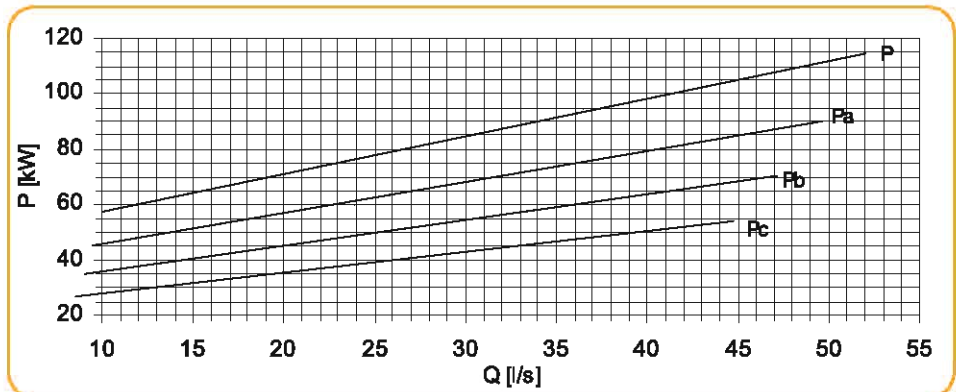

Efficiency

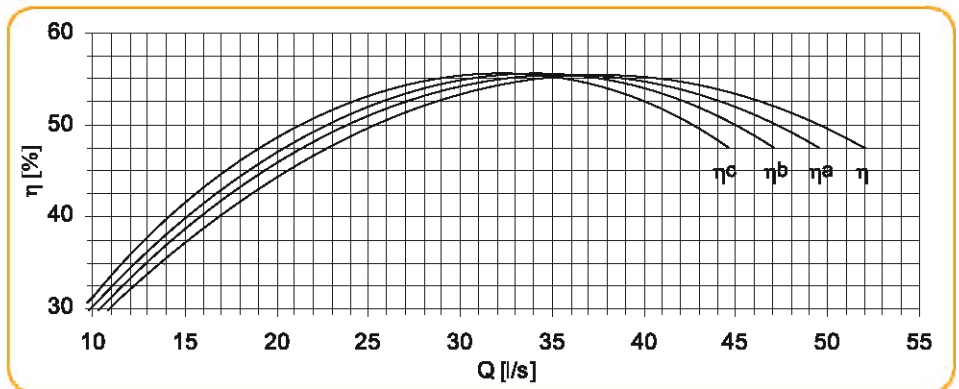

Net Positive
Suction Head

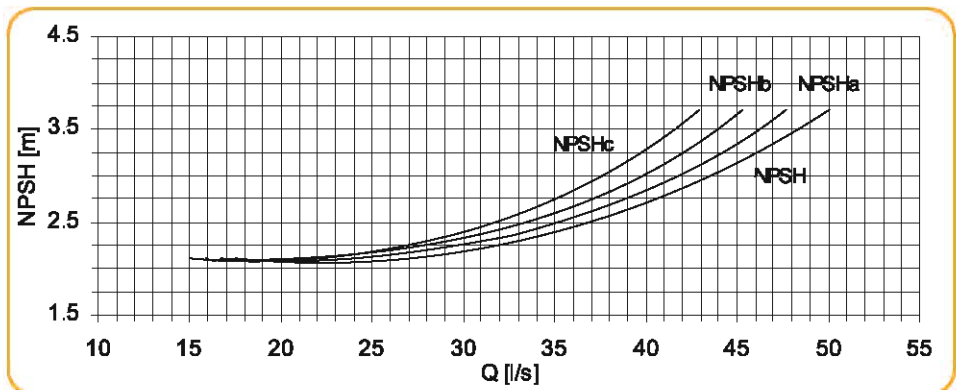

Pump performance curves

Total
Differential
Head

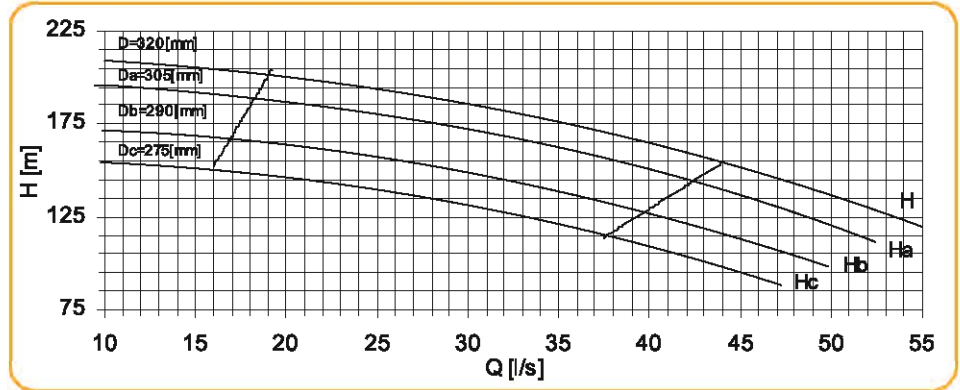

Power Input

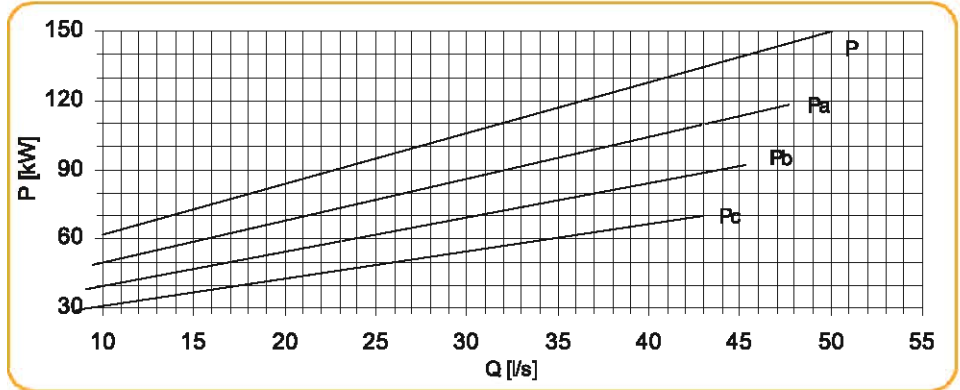

Efficiency

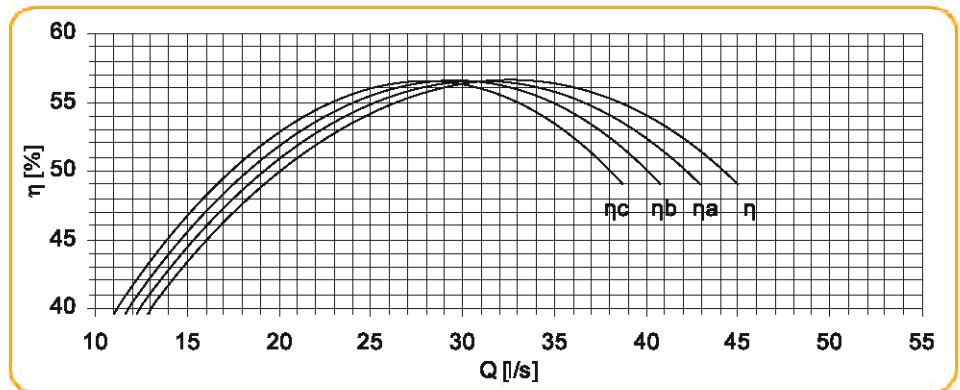

Net Positive
Suction Head

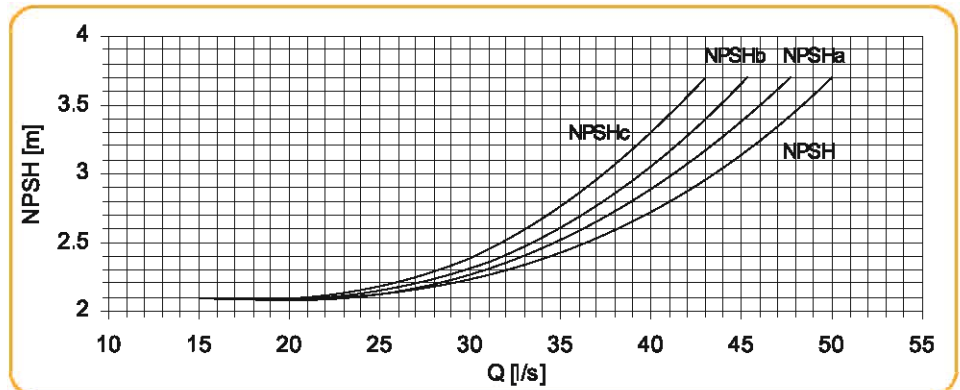

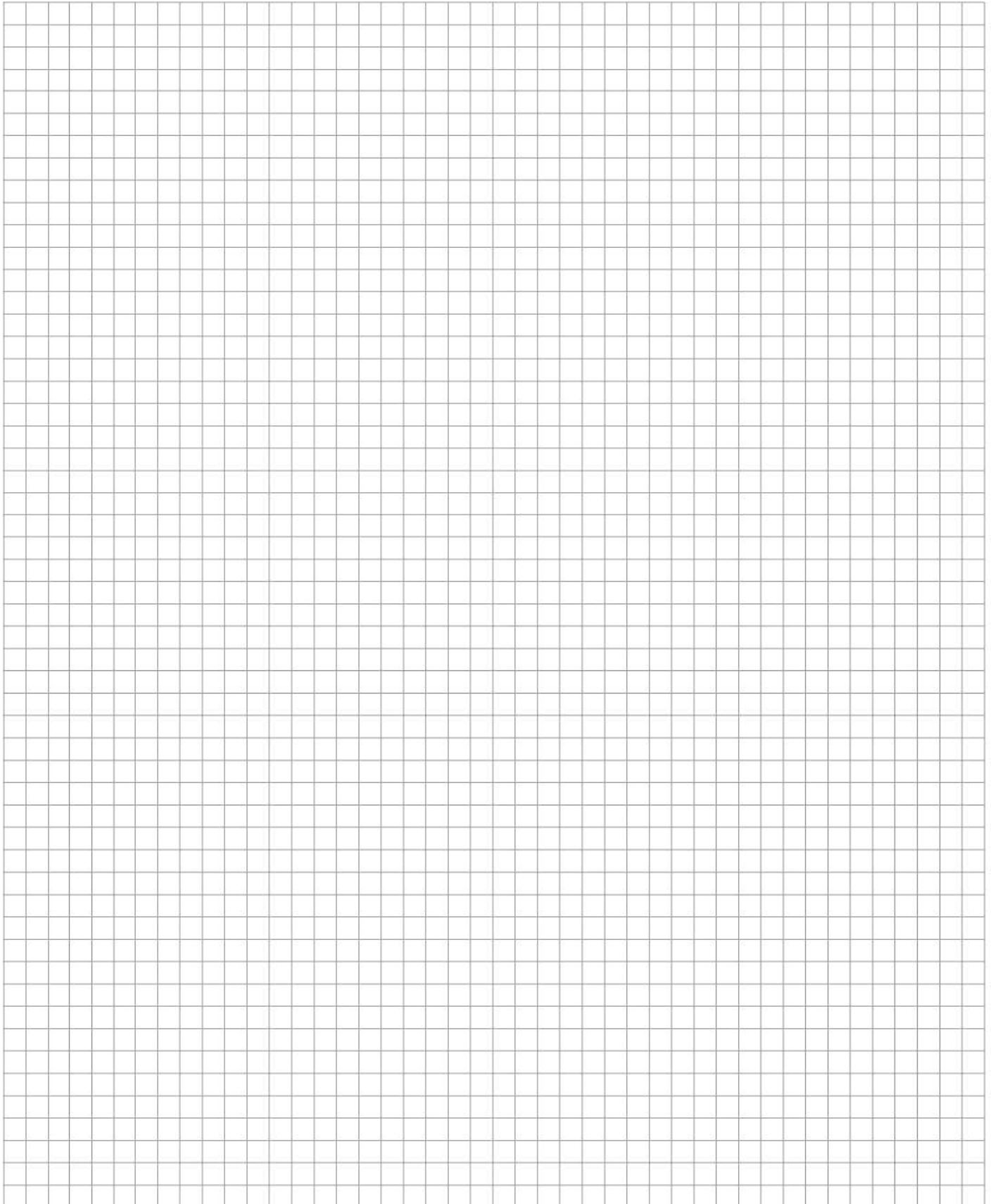



Pero Nakov Str. bb. 1000 Skopje, Republic of Macedonia
Tel. +389 2 2549 817 / 818, Fax. +389 2 2549 833 / 834
www.pumpi.com.mk; e-mail: info@pumpi.com.mk